

ENGLISH

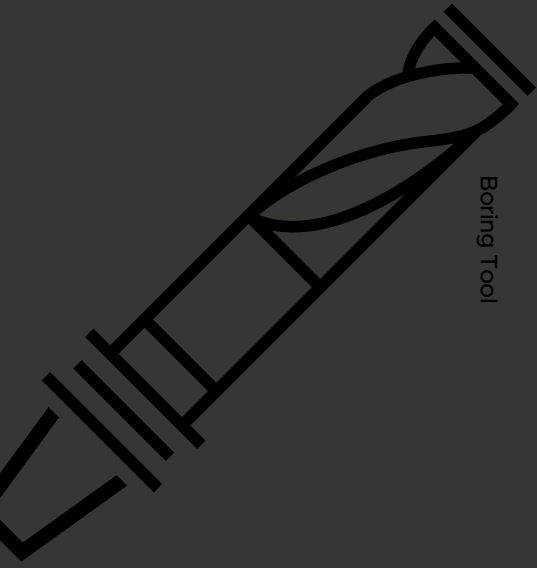

Boring Tool



CBN

2023 NC TOTAL TOOLING SYSTEM

DINOX



PCD

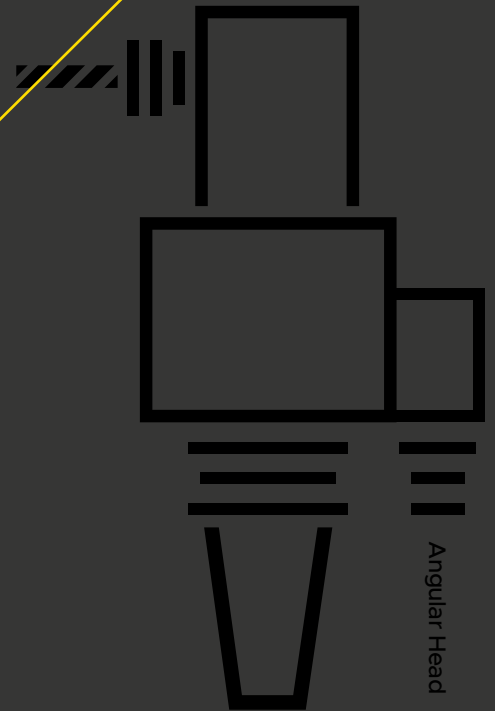

Angular Head

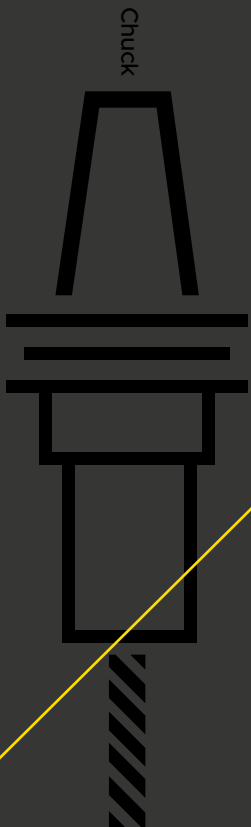

Chuck

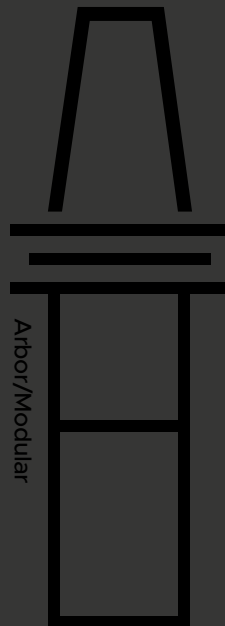

Arbor/Modular

We will be the leading global company
with the **best technical skills**





CONTENTS

006 Global Networks	028 Balancing System	159 Boring Tool
008 DINE Products	030 DBT Series	223 Angular Head
010 DINE History	031 HSK Tooling System	247 cBN/PCD
012 Tool Application	032 Catalog Manual	293 TAUMAX
016 DINOX Map	033 Chuck	307 Other
020 Master Index	137 Arbor Modular	324 ABC Index

DINE Inc. makes a better world
with its **technologies and quality**
in addition to **customer confidence.**

By supplying our customers with high-quality products, we contribute to the development of the automobile, electronics, machinery, and plant industries. Furthermore, we make every effort to demonstrate the excellence of Korean cutting tools to the world by exporting our superior-quality cutting tools overseas.



Achieved ISO quality management system certification

KS Q ISO 9001:2009 / ISO 9001:2008

SBC certifies that the above company's environmental management system meets the requirements of the system standards and certification scope below.



Achieved ISO environmental management system certification

KS I ISO 14001:2009 / ISO 14001:2004

SBC certifies that the above company's management system meets the requirements of the standards and certification scope below.



We have manufactured high-quality
T/H products using high-precision
equipment and advanced CAM software.

T/H



We have manufactured cBN and
PCD tools essential for machining
automobiles, airplanes, and ships, etc.

cBN

T/S



We have also manufactured
MCT (Machining Center) tools
and T/S (Tooling System).

Homepage



Instagram



YouTube



KakaoTalk Plus



DINE GROUP GLOBAL NETWORKS

DINE GROUP HEAD OFFICE

- DINE HEAD OFFICE / DINE FACTORY KOREA
- DINE HEAD OFFICE / DINE FACTORY KOREA
- WIDIN HEAD OFFICE ● DSP HEAD OFFICE

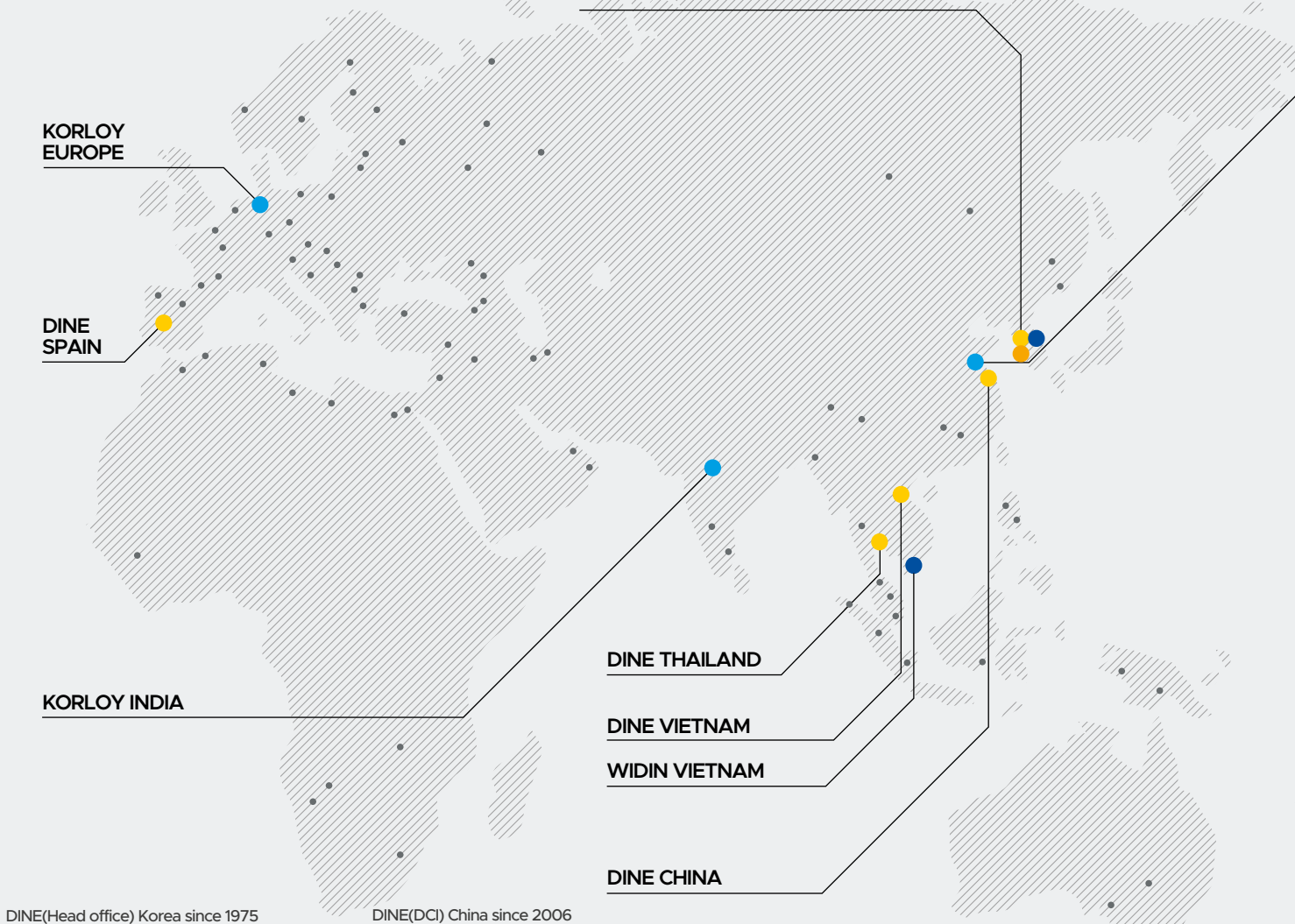

DINE(Head office) Korea since 1975

DINE(DCI) China since 2006



DINE(DVC) Vietnam since 2017

DINE(DTC) Thailand since 2019

DINE(DMS) Spain since 2022



KORLOY Korea since 1966

WIDIN Korea since 1988

DSP Tooling inc. Korea since 2000

- DINE FACTORY QINGDAO
- KORLOY FACTORY QINGDAO

WIDIN AMERICA

KORLOY AMERICA

KORLOY BRASIL

KOREA NETWORKS

- KOROLY Head Office
- Gyeongjin Branch
- DSP Head Office
- DINE Inc. Head Office (MTV)
- Jungbu Branch
- KOROLY Jincheon Factory
- Daegu Branch
- Nambu Branch
- Nambu Support Center SMART FACTORY
- Changwon Branch
- WIDIN Head Office

Gyeongjin Branch



Jungbu Branch



Daegu Branch

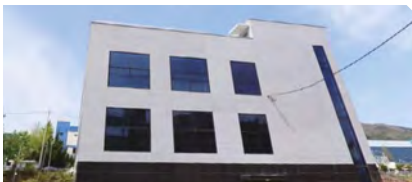

Nambu Branch



Changwon Branch



Nambu Support Center(SMART FACTORY)



Boring tool 

Chuck 



Arbor 



Other 

DINE PRODUCTS

02	08	05
01		06
03	04	07

1 Chuck

High-speed, high-precision machining with strong gripping power and perfect balancing work

2 Boring tool

DINOX boring tools are designed with precise and reliable tolerances for stable and fast machining, and produce that can be work from small to large diameters.

3 Other

For precision machining, a product group that can prevent damage to materials and tools by identifying expected problems



Angular head 1

cBN 2

Smart factory 3

TAUMAX 4

PCD 5

4 Arbor

A product with strong clamping force by fastening tools with bolts

5 Angular head

A tool holder that can perform two functions with one machine with various machining angles and stable operation

6 TAUMAX

A low-end product brand launched by DINE to help reduce production costs at an economical price

7 PCD

A tool for cutting non-ferrous work piece that uses synthetic diamond to ensure an excellent machining surface and tool life.

8 cBN

It is a cutting tool made of cubic boron nitride for processing hard materials and guarantees excellent cutting performance and stable tool life

DINE HISTORY

1975

- 1975. 07** Founded Hanju Trading Company (sale of imported Cemented carbide alloy cutting tools)
- 1988. 07** Converted into a corporation and renamed DINE, Inc., Im Sang-jin inaugurated
- 1989. 02** Produced holders and locator, started OEM supply to Korloy
- 1990. 04** The manufacturing technology of NC Tooling System was introduced from Kyoritsu Seiki (Japan); Made a contract (for 5 years); Approved by the Commerce-Industry
- 1994. 08** Ministry Signed a contract for introducing the manufacturing technology of cBN cutting tools with Sumitomo in Japan
- 1995. 12** TOOLING SYSTEM factory was transferred (Sihwa Industrial Complex own factory move-in)
- 1997. 03** cBN/PCD factory was transferred (Sihwa Industrial Complex)
- 1997. 09** Started the localization of the integral angular head of Kyoritsu Seiki (Japan)
- 1998. 11** The head office was transferred (1257-4, Jeongwang-dong, Siheung-si, Gyeonggi-do (Sihwa Industrial Complex 2-da 705))
- 1999. 08** Changed company name to DINE after the merger of (Dine, Inc., Dine Co., Ltd., Ilshin Industry, Presto Co., Ltd.)

2000

- 2000. 02** Designated as IBK Family Enterprise (IBK : outstanding enterprise)
- 2001. 07** Achieved ISO 9001 : 2000 certification (SMB Certification Center)
- 2001. 11** Awarded the 3 Million Dollar Export Tower Prize on the 38th Trade Day
- 2003. 03** Applied for a patent on milling chuck with tightening precision improved (application no. 10-2003-0015317) Awarded the 5 Million Dollar Export Tower Prize on the 41st Trade Day
- 2004. 11** Awarded the 10 Million Dollar Export Tower Prize on the 43rd Trade Day
- 2006. 01** Opened the second Sihwa factory
- 2006. 04** Selected as a company qualified for SMB learning organization business (HRD Korea)
- 2006. 06** Established DINE China, Inc. (DCI)
- 2006. 10** Established DINE Tool R&D Center; Approved by KOITA
- 2006. 11** Awarded the 10 Million Dollar Export Tower Prize on the 43rd Trade Day
- 2006. 12** Designated as a technology-innovation SMB (INNO-BIZ) by the SMBA
- 2007. 01** Opened the knowledge management system "Dian(다이안)"
- 2007. 04** KIPO No.10-0713805 "Milling chuck with a strong structure preventing foreign substance penetration"
- 2007. 06** Opened a call center
- 2007. 08** Selected as a Gyeonggi-do promising SMB (for 5 years)
- 2007. 10** Established a manufacturing corporation in China
- 2007. 12** Received a presidential citation on the 7th Machinist Day (Chairman Yoon Hye-seop)
- 2008. 07** Broke ground for the manufacturing corporation in China
Achieved zero hazard goal twofold
- 2008. 10** Achieved zero hazard goal threefold
- 2008. 12** Awarded the 20 Million Dollar Export Tower Prize on the 45th Trade Day /
Awarded the 3rd Gyeonggi SMB Prize - export field
- 2009. 12** Signed an MOU with the Qingdao Bonded Area / Held the completion ceremony for the manufacturing corporation in China

2010

- 2010. 02** Applied for a patent on the tool holder mounting system (application no. 10-2010-0012422)
- 2010. 03** Built WEB ERP (enterprise resource planning)
- 2010. 06** System Signed a function promotion agreement (HRD Korea)
- 2010. 07** Awarded the 8th Siheung-si Woman Prize (Chairman Yoon Hye-seop) - economy field
- 2010. 09** Selected as an outstanding enterprise for human resource development (Best HRD)
- 2010. 11** Productivity management system (PMS) was confirmed / Awarded IBK Export Tower - Stone Tower / Designated as a management-innovation SMB (MAIN-BIZ) by the SMBA



2023

- 2011.03 Awarded "Trader prize of this month who has brought glory to Korea" - Chairman Yoon Hye-seop
- 2011.05 "National team member agreement for the 41st UK International Vocational Training Competition"
- 2011.08 KIPO No.10-1060687 Cutting tool module of a machine tool using the dual pitch screw method
- 2011.09 ISO 14001 certification
- 2011.11 Zero hazard goal achievement threefold certification (Head office), Zero hazard goal achievement threefold certification (Factory)
- 2011.12 Awarded the 30 Million Dollar Export Tower Prize on the 48th Trade Day
- 2012.04 Achieved Excellent Green Biz certification (SMBA) - grade A
- 2012.05 Selected as an enterprise qualified for Korean-style hidden champion promotion (Export-Import Bank of Korea)
- 2012.08 Signed a rehabilitation social contribution project agreement (Siheung City Hall)
- 2013.03 Received a citation from the Minister of Knowledge Economy on the 40th Day of Commerce and Industry : Yoon Hye-seop
- 2013.04 Received a citation from the Chairman of Fair Trade Commission on the 12th Day of Fair Trade : Yoon Hye-seop
- 2013.07 Established FTA SYSTEM
- 2013.08 Obtained country of origin certification & exporter certification
- 2013.12 Awarded Siheung City 1% welfare foundation sponsor company citation by Siheung Mayor
- 2014.06 Acquired DSP Tooling (DSP)
- 2014.12 Established the standard cost operation system
- 2015.07 Opened the Incheon Logistics Center (DIW)
- 2015.12 Head office and factory were integrated and transferred - Siheung Smart Hub MTV Industrial Complex
- 2016.01 Introduced and established an automatic warehouse system / Established small tool production system for the IT industry / Newly established Busan branch
- 2016.04 Held the completion ceremony for the Sihwa Smart Hub MTV new factory
- 2016.07 Awarded a presidential medal on the 2nd Day of Enterprise of Middle Standing (Chairman Yoon Hye-seop)
- 2016.11 Awarded the Creation Technology Prize in the autumn symposium by KSMTE (Chairman Yoon Hye-seop)
- 2016.12 Awarded the 50 Million Dollar Export Tower Prize on the 55th Trade Day (Achieved 100 billion won of annual sales)
- 2017.01 Launched TAUMAX second brand; started to sell products
- 2017.02 Opened Vietnam branch (DVC)
- 2017.03 Started the solar energy generation project
- 2017.04 Selected as a 2017 small hidden champion (MOEL)
- 2018.01 Newly established Robot Division
- 2018.06 Celebrated Company's 30th anniversary
- 2018.08 Opened Nambu Branch (Ulsan/Changwon/Busan integrated)
- 2018.10 Acquired WIDIN Co., Ltd.
- 2019.11 Opened DINE SMART FACTORY Nambu Support Center
- 2020.01 Changed to independent CEO system, inaugurated as CEO Yim Soo-min
- 2020.03 Opened Thailand Branch (DTC)
- 2021.12 Received the Innovative Growth Management Award (corporate category)
- 2022.01 Establishment of Changwon Sales Office
(Changwon, Jinjoo, Sacheon, West Gyeongnam area)
- 2022.06 Established Southern Europe Branch (DMS)



TOOL APPLICATION

GSK

Milling, Drilling, Reaming, Chamfering

OFH

Deburring

DBC

Rough Boring

DHE

Milling, Drilling
Reaming

SAH

Drilling

FBH/B

Boring

FBH/B

Back Boring

NPM

Milling, Drilling

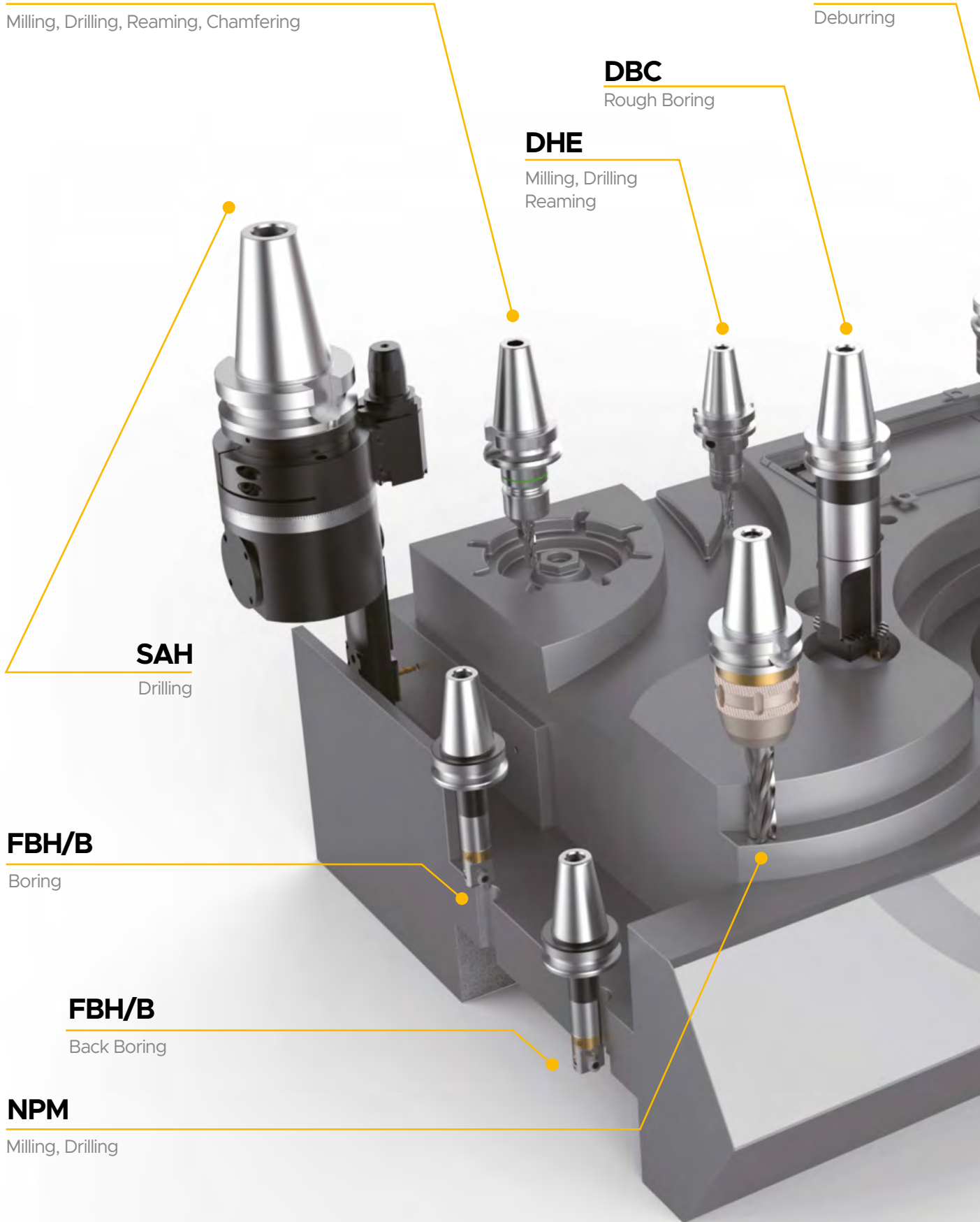

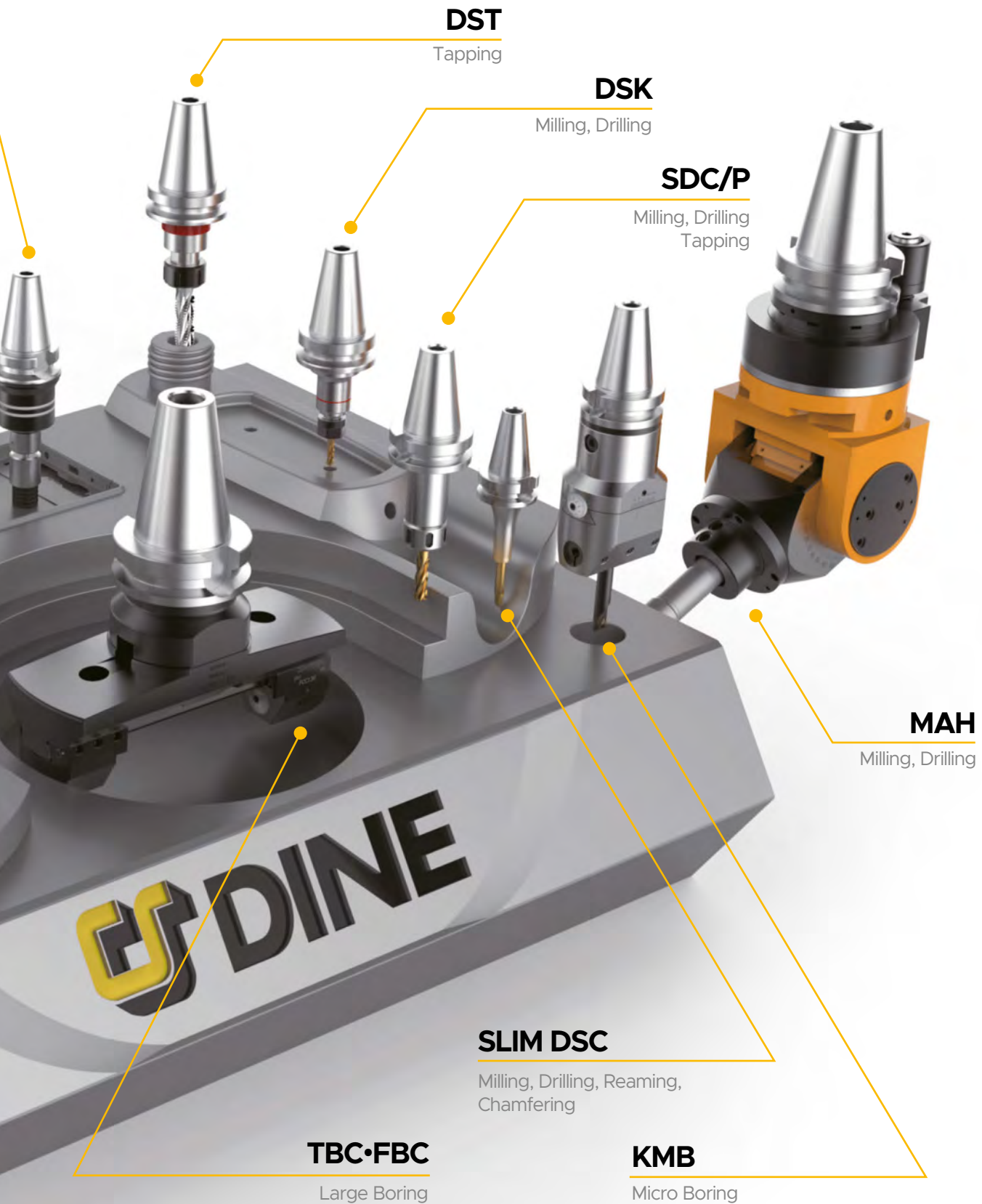

DST
Tapping

DSK
Milling, Drilling

SDC/P
Milling, Drilling
Tapping

MAH
Milling, Drilling

SLIM DSC
Milling, Drilling, Reaming,
Chamfering

TBC•FBC
Large Boring

KMB
Micro Boring

ANGULAR HEAD APPLICATION

KHU

Free angle type
Angular Head

KAC

45° angle type
Angular Head

HRAG

Attachment type Angular Head
(Rigid reinforced type)

KAH

90° angle type Angular Head
(BT30 Shank)

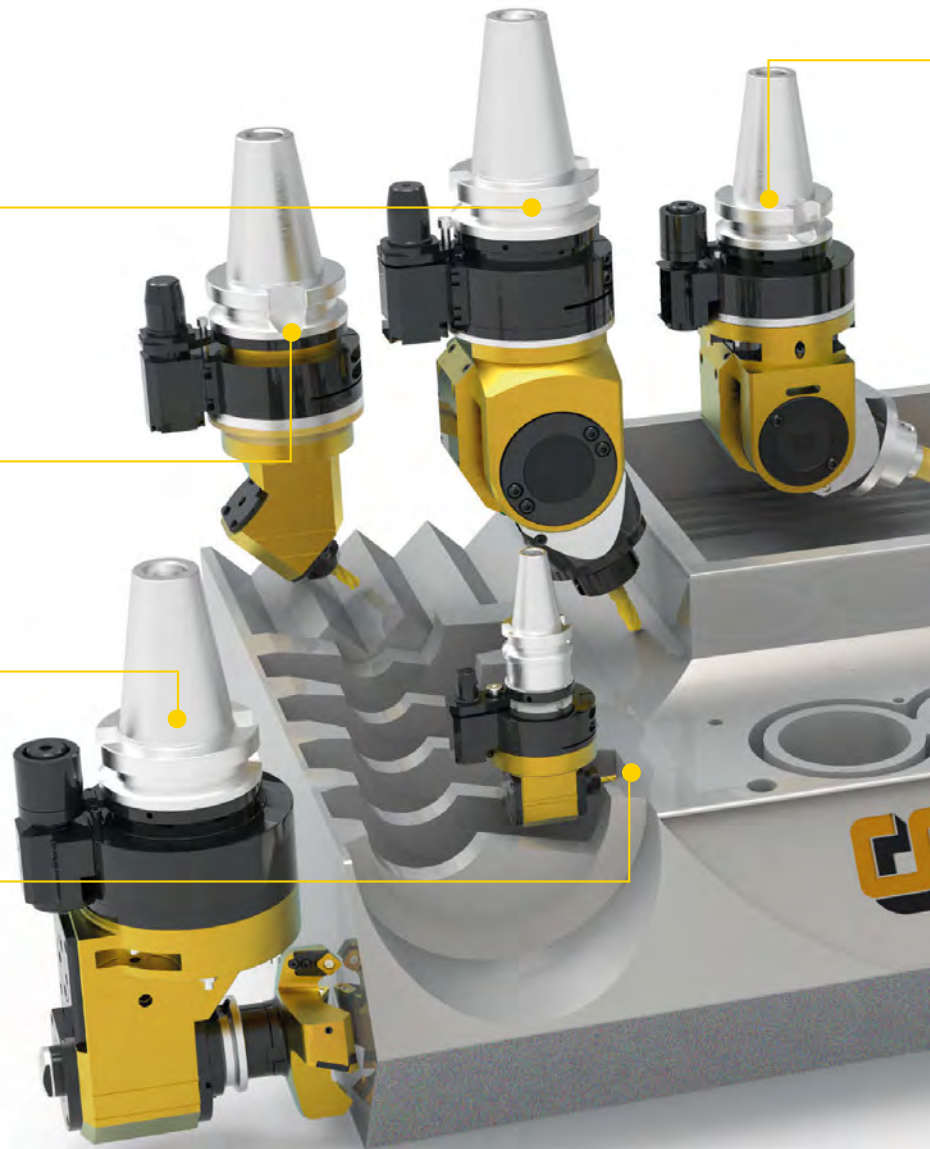

KHU

Free angle type Angular Head

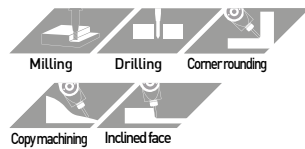

KAG

Attachment type Angular Head

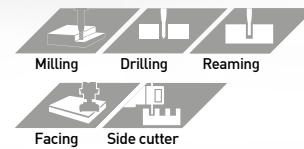

MAH

Free angle type Angular Head
(Rigid reinforced type)

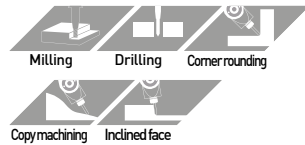

HRAG

Attachment type Angular Head
(Rigid reinforced type)

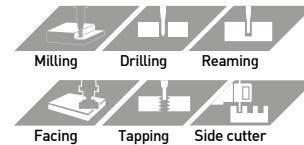

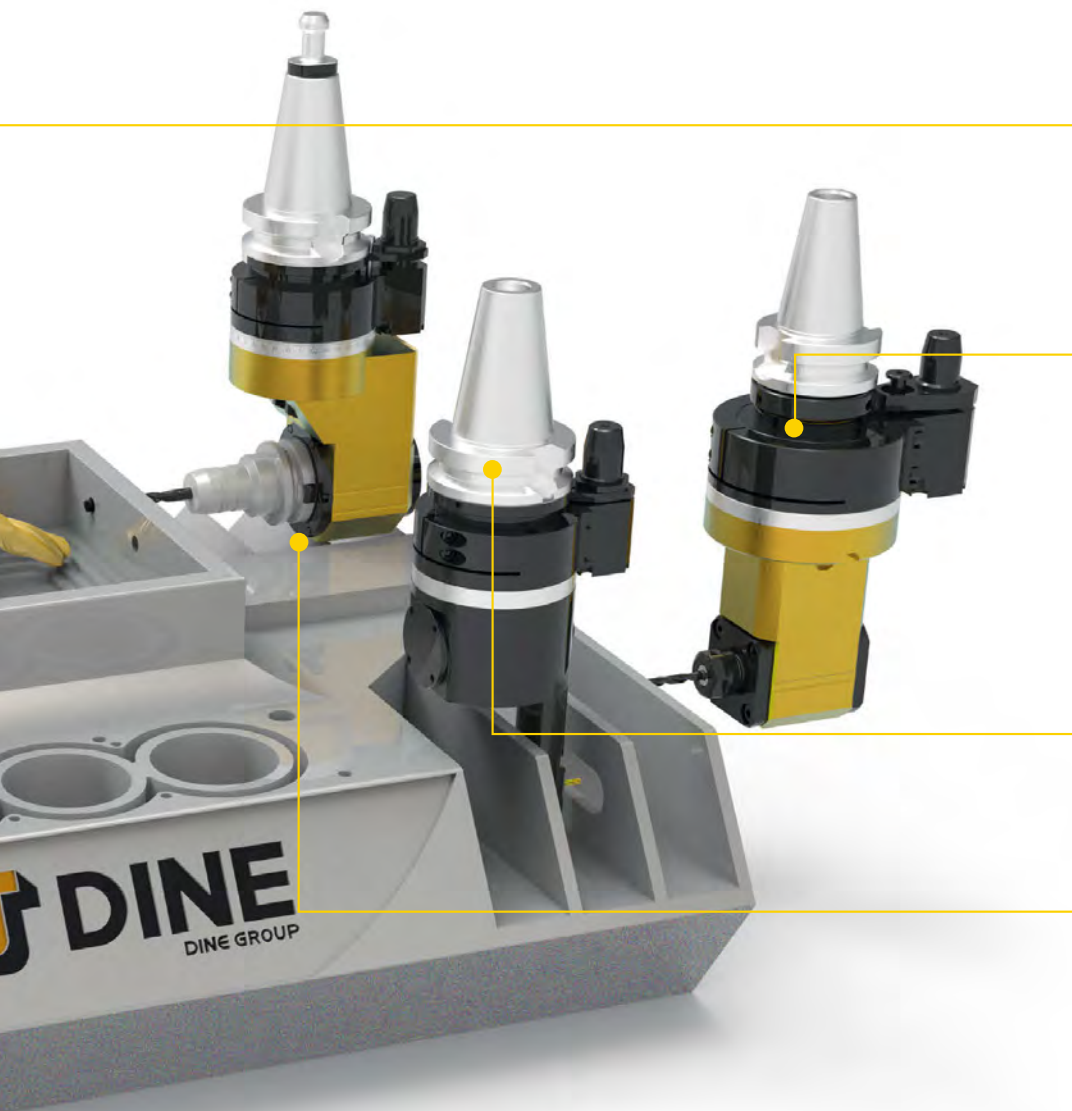

MAH

Free angle type Angular Head
(Rigid reinforced type)

KAH

90° angle type Angular Head

SAH

Slim Angular Head

KAG

Attachment type
Angular Head



KAC

45° angle type Angular Head



Slope machining Milling



KAH

90° angle type Angular Head



Milling Drilling

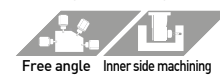

Free angle Inner side machining



SAH

Slim Angular Head



Milling Drilling

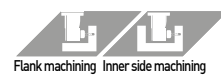

Flank machining Inner side machining

1. Hydraulic Expansion Chuck

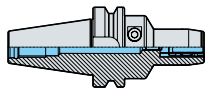

DHE Hydraulic expansion chuck

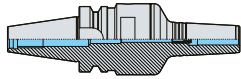

DHE/S Slim hydraulic expansion chuck



DHC DHC collet (General type)



DHC[P] DHC collet (Waterproof type)



DHJ Jet coolant collet



DZC Zero fit collet

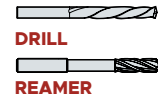

DRILL
REAMER



ENDMILL
BURNISHING DRILL

2. Shrinking Chuck

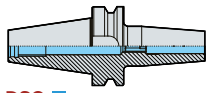

DSC Shrinking Chuck

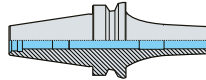

DSC/M Shrinking Chuck (Mono curve type)

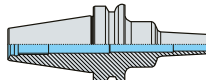

DSC/S Shrinking Chuck (Mono slim type)

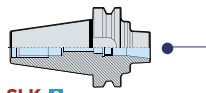

SLK Shrinking Chuck (2Pieces type)



S-FBH/B Micro boring bar

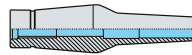

CM/CS Shrinking Chuck (2Pieces type)

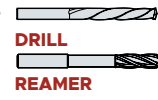

DRILL
REAMER



ENDMILL
BURNISHING DRILL

3. Tapping Holder

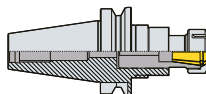

DST High speed synchro tapping chuck

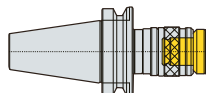

DTN Tapping holder



TER **ER COLLET**
TER Collet



TCA Tap adapter



TEH Tap extension holder



TAP



TAP

4. Drill Chuck

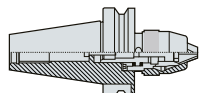

NPU Drill chuck



Drill

5. Floating Holder for Brush

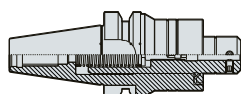

OFH Floating holder for brush



ST-OFH Floating holder for brush



Brush

6. Collet Chuck

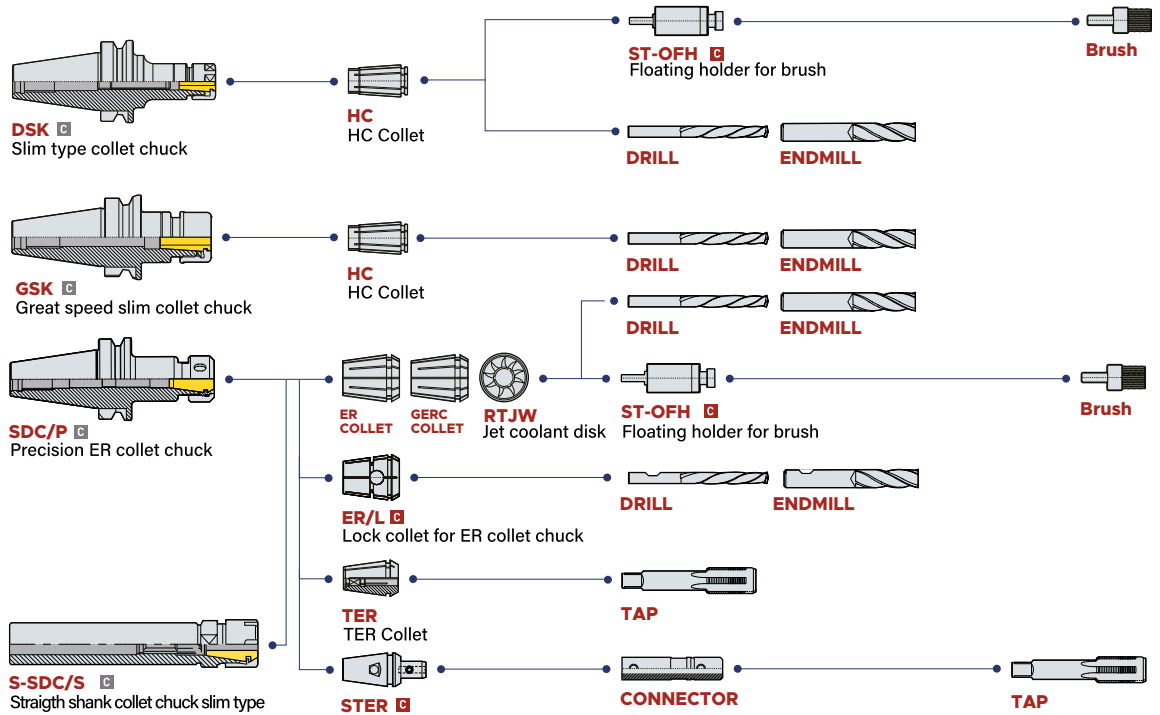

7. Milling Chuck

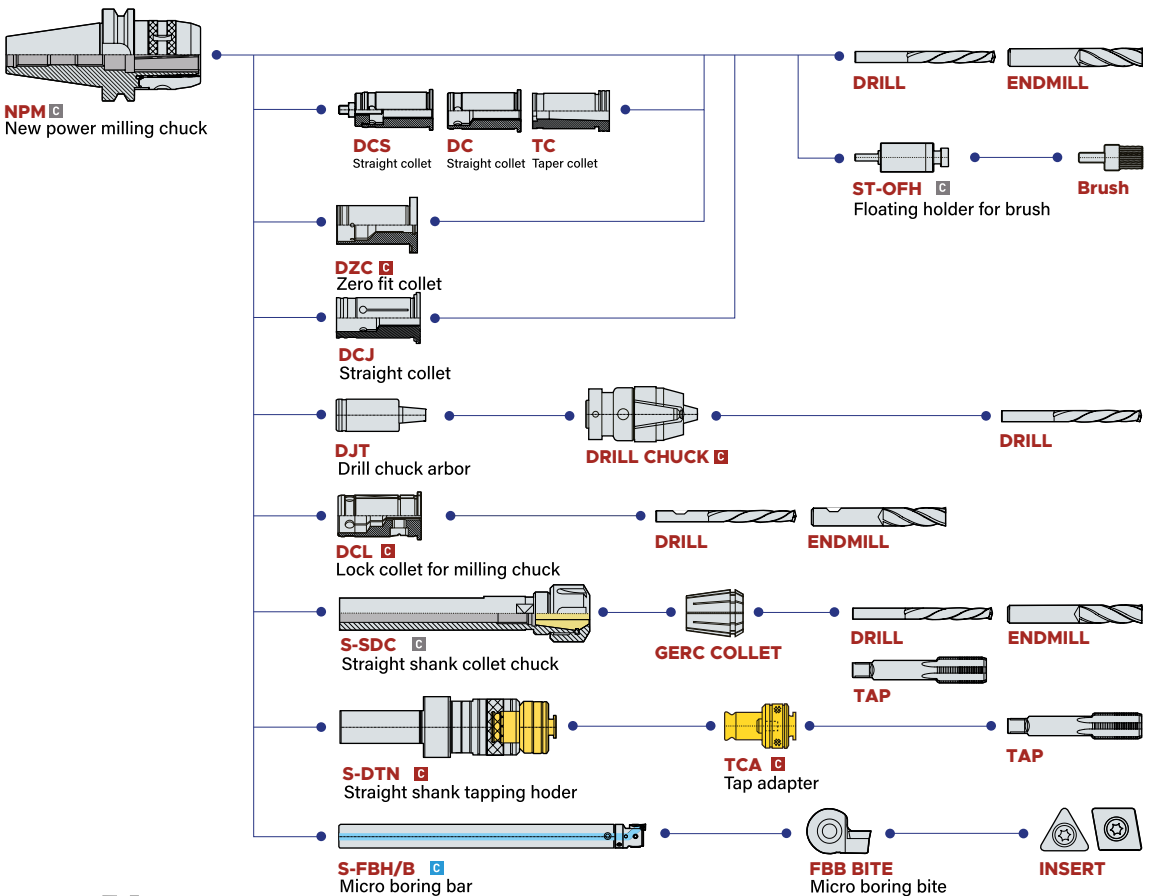

8. Side Lock Arbor

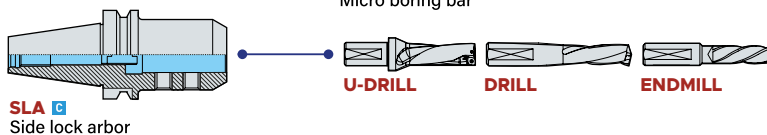

9. Morse Taper Arbor

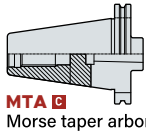

MTA Morse taper arbor



DRILL **REAMER**

10. Face mill Arbor

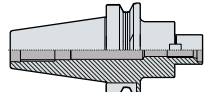

FMA Face mill arbor

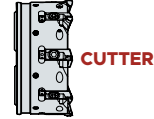

CUTTER

11. Air Spindle

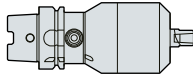

ATM Air turbine machine

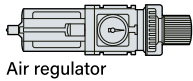

Air regulator



HC HC Collet **DRILL** **ENDMILL**

12. Angular Head

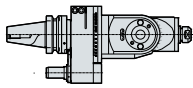

KHU Free angle type angular head



GERC COLLET **DRILL** **ENDMILL**

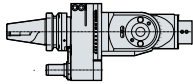

MAH Free angle type angular head



DRILL **ENDMILL**

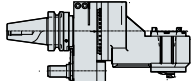

HRAG / KAG Attachment type angular head

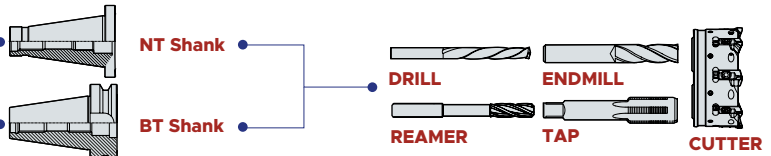

NT Shank **BT Shank** **DRILL** **REAMER** **ENDMILL** **TAP** **CUTTER**

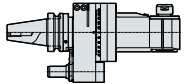

KAH 90° Angle type angular head



GERC COLLET **DRILL** **ENDMILL**

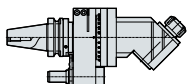

KAC 45° Angle type angular head



GERC COLLET **ENDMILL**

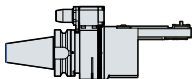

SAH Slim angular head



SAH COLLET **DRILL** **ENDMILL**

13. Boring Series

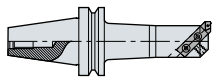

BSA Square boring bar



BH Square boring bite for BSA

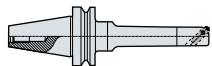

BKA FZ Micro boring bar

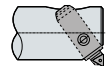

FZ UNIT Inclined mounting type

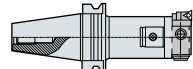

BCF Micro boring bar

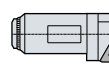

FF UNIT Micro boring Bar



INSERT

13. Boring Series

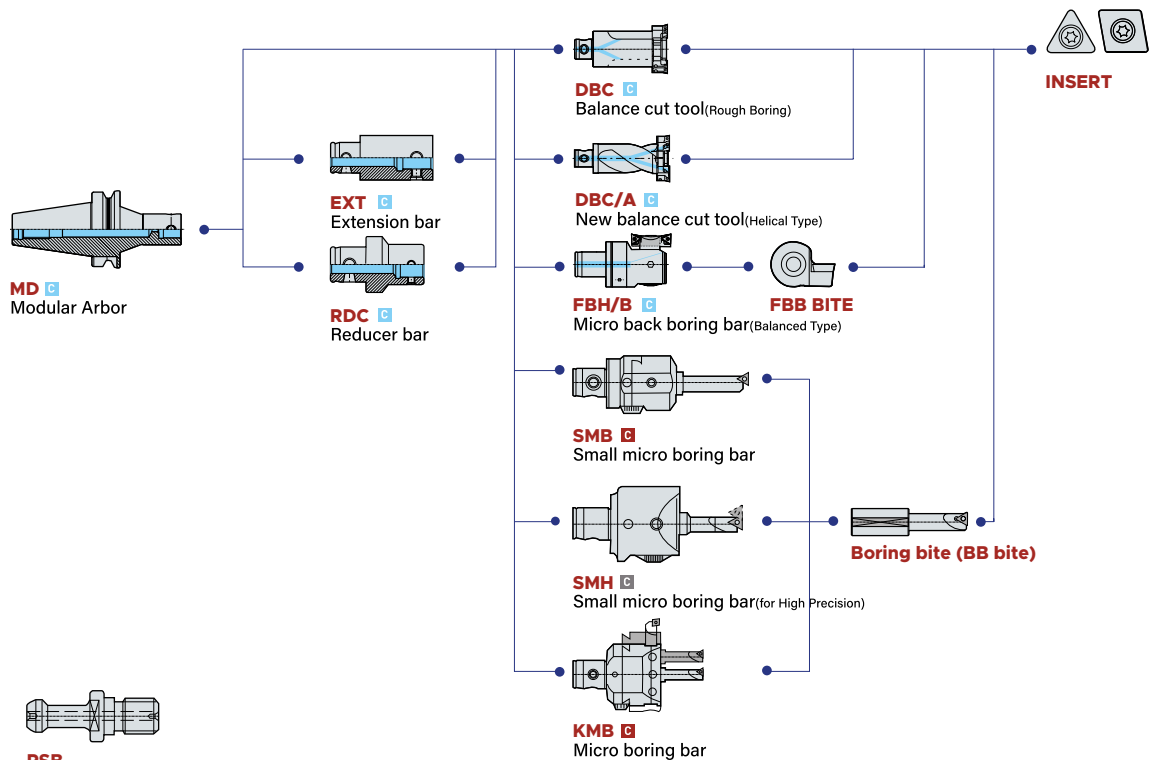
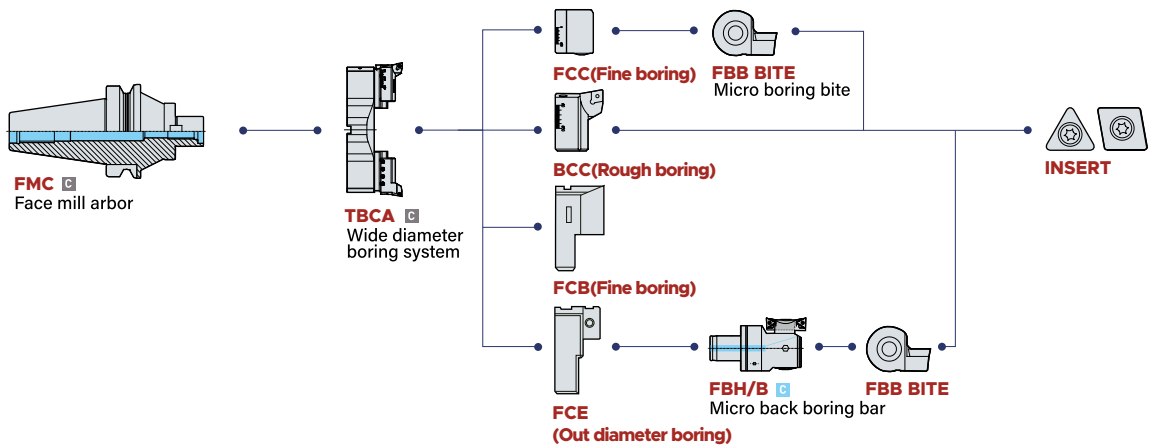
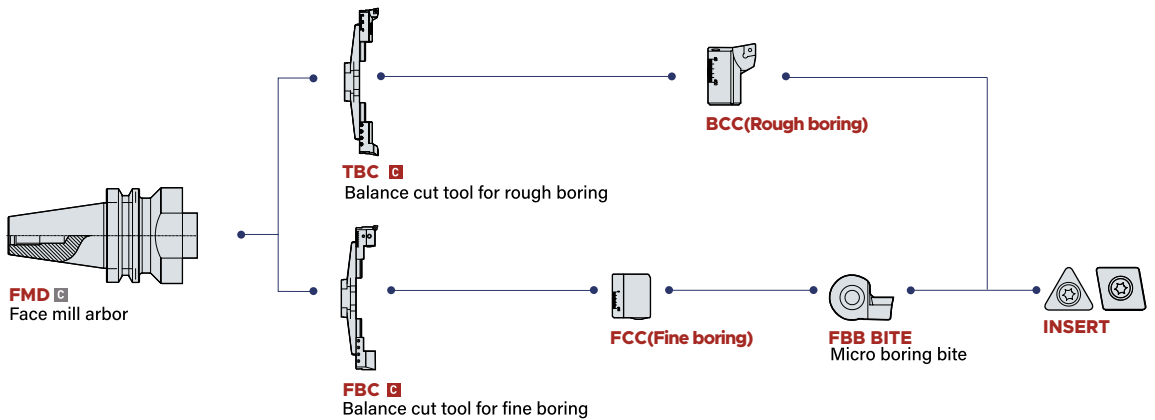

14. Pull Stud Bolt

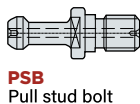

C Internal coolant system is basic

c Internal coolant system is optional

C This product does not support the internal coolant system

CHUCK



C

DHE/S
Slim hydraulic expansion chuck

34p



C

DHE
Hydraulic expansion chuck

37p



C

DSC
Shrinking chuck

49p

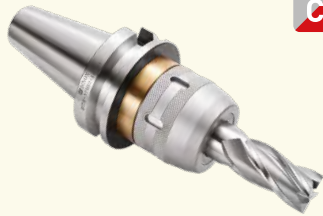

C

NPM
New power milling chuck

65p



NEW **C**

SDC/PL
Precision collet chuck
(Length adjustment type)

82p



C

SDC/P
Precision collet chuck for
multi purpose machining

86p



C

DSK
Slim type collet chuck

108p



C

GSK
Great speed slim type collet chuck

112p



C

NPU
Drill chuck

120p



C

DTN
Tapping holder

122p



C

TCA
Tap adapter

125p



C

DST
High speed synchro tapping chuck

126p

Arbor Modular



NEW **C**

TEH
Tap extension holder

130p



C

OFH
Floating holder for brush

134p



C

SLA
Side lock arbor

138p



C

MTA
Morse taper arbor

142p



C

FMA
Face mill arbor

143p



C

FMC
Face mill arbor

146p



C

MD
Modular arbor

150p



C

RDC
Reducer bar

156p



C

EXT
Extension bar

156p



C

FBH/B
FBH Back boring & balanced type

160p



C

DBCA
New balance cut tool

170p



C

DBC
Balance cut tool(Rough boring)

180p

Boring Tool

C Internal coolant system is basic

c Internal coolant system is optional

C This product does not support the internal coolant system

Boring Tool



C

TBCA

Wide diameter boring system

186p



C

TBC

Balance cut tool for Rough boring

192p



C

FBC

Balance cut tool for Fine boring

197p



C

SMB

Small micro boring bar

202p



C

KMB

Micro boring

204p



C

SMH

Small micro boring bar

206p



BB BITE

BB bite(for SMB, SMH, KMB)

210p



BH

Square boring bite for BSA

211p



C

BSA

Square boring bar

212p



C

BKA

FZ micro boring bar

214p



FZ UNIT

FZ unit inclined mounting type

216p



C

BCF

Micro boring bar

218p

Angular Head



FF
FF unit

220p



SAH
Slim angular head

227p



KHU
KHU(0°-90°)

228p



MAH
MAH for mold(0°-90°)

230p



KAG
Attachment type KAG

232p



HRAG
HRAG(90° fixed)

234p



KAH
Modular type KAH(90° type)

236p



KAC
Modular type KAC(45° type)

238p



ATM
Air turbine machine

242p



DNC100
Coating cBN

270p



DNC250
Coating cBN

271p



DNC300
Coating cBN

272p

cBN/PCD

C Internal coolant system is basic

c Internal coolant system is optional

C This product does not support the internal coolant system

cBN/ PCD



DNC350
Coating cBN

273p

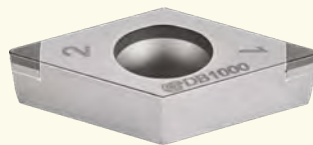

DB1000
Non coating cBN

274p



DB2000
Non coating cBN

275p

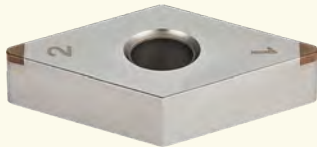

DB7000
Non coating cBN

276p



DB7500
Non coating cBN

277p

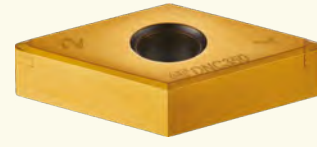

RA,GA Chipbreaker
cBN chipbreaker

278p



UC Chipbreaker
New PCD insert chipbreaker

288p



DP150
PCD

289p



DZC
Zero fit collet

48p

C



DCJ
DINE Jetcoolant collet

67p

c



DCL
Lock collet for milling chuck

79p

C

Accessory



GERC
GERC collet

95p



ER COLLET
ER collet

100p



ER/L
Lock collet for ER collet chuck

104p



RTJW
Jet coolant disk

106p



HC COLLET
HC slim collet

118p



TER
TER collet

129p



STER
STER collet

133p



PVT
MC Power vise - PVT

294p



PVTM
MC Power vise - PVTM

295p



DVT
Doble Lock & Anglock vise - DVT

297p

TAUMAX

C Internal coolant system is basic

C Internal coolant system is optional

C This product does not support the internal coolant system



MVT
MC Machine vise - MVT

297p



FVT
5-AXIS CENTERING VISE

298p



TAPER CLEANER
Taper cleaner

300p



MH-200
MH-200

301p



CLEAN-TEC FAN
Clean-tec fan

302p



C
MICRO ADJUSTING CARTRIDGE
Precision micro adjusting cartridge

303p



PULLSTUD BOLT WRENCH
Pullstud bolt wrench

303p



TOOL CLAMP
Tool clamp

304p



MAGNETIC BASE
Magnetic base

305p

Other



DIGITAL 3D TASTER
Digital 3d taster

308p



3D TASTER 2007
3D taster 2007

308p



HDG
Hydraulic expansion chuck gauge

309p



DZH
DINE Z axial height gauge

310p



DZP
DINE Z axial setting height gauge

310p



DOP
DINE Optical edge finder

311p



DZOP
DINE Z axial P reset gauge

311p



ROT
Run-out tester

312p



TB
Test bar

313p



SC
Spindle cleaner

313p



NTSS
New tool setting stand

314p



PULL STUD BOLT
Pull stud bolt

323p



BALANCING SYSTEM

The necessity of balancing work

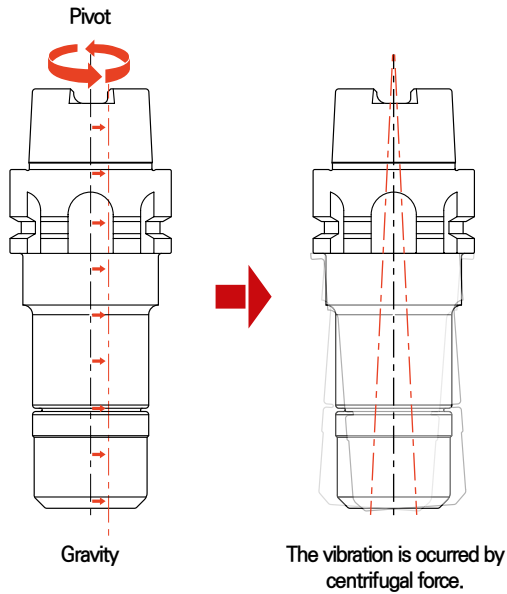

The cause of unbalancing

Asymmetry of tool holder shape and weight imbalance.

The problem of unbalancing

The vibration in the tool by centrifugal force leads to noise and deterioration of surface roughness and tool life.

The necessity of balancing work

Balancing work is necessary for better surface roughness, accuracy and tool life.

※ The phenomenon is that the center of gravity in tool keeps off from a pivot

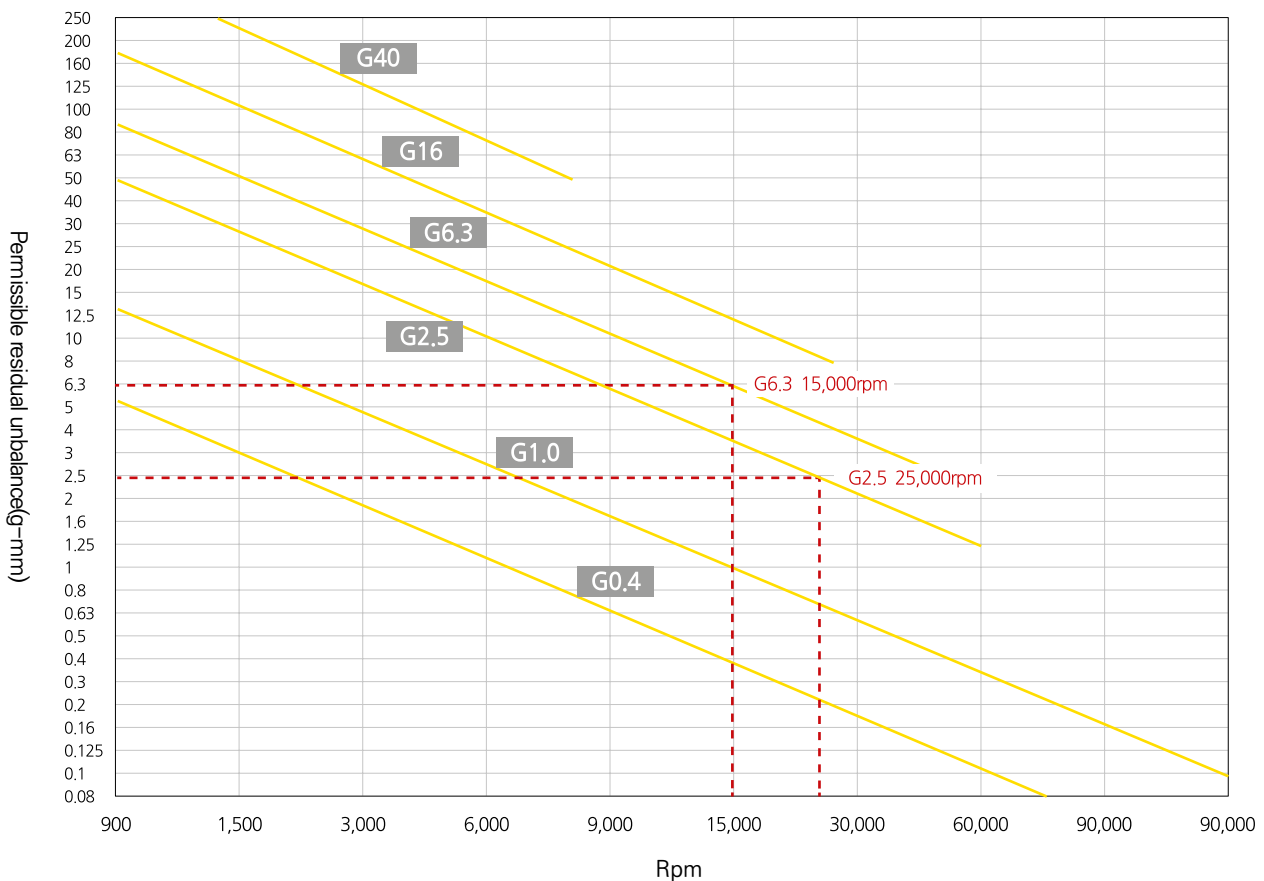



BALANCING SYSTEM

Balancing

The most optimal accuracy at high speed

1. Keep high accuracy and rigidity without bending of rotating product due to unbalanced load.
2. Excellent balance. ($\leq G2.5$ or $0.5 \text{ g} \cdot \text{mm}/\text{kg}$)
3. Improve tool life, surface finish, dimension of accuracy and productivity at high speed.

Balancing Grade Standard

The possibility of multiple balancing's quality.

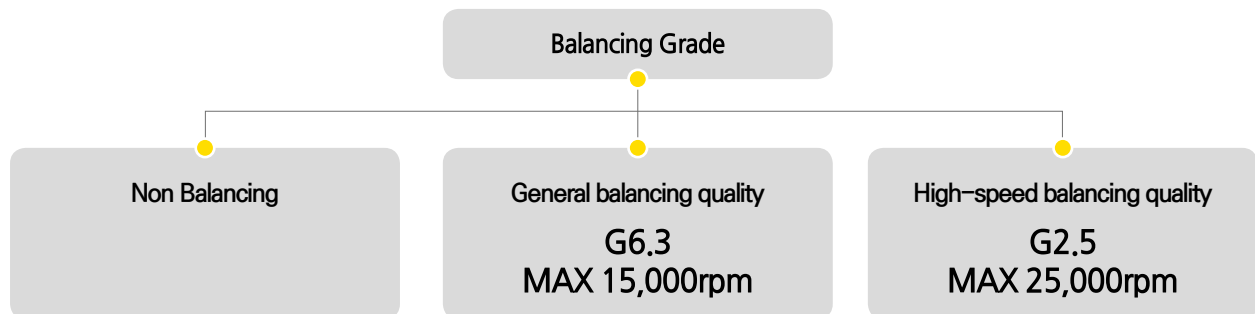

BT, SK Shank	HSK Shank
Balancing type with hole	Balancing type with hole



DBT Series PAT.

For high speed

DBT spindle system

2 Face contact type (taper and flange face) for high speed, roughing, finishing and surface roughness

The advantage of 2 face contact type

- Improved surface quality and dimensional accuracy
- Extended tool life
- Improved ATC repeatability
- Eliminate Z-axis movement error during high-speed movement



BT Type

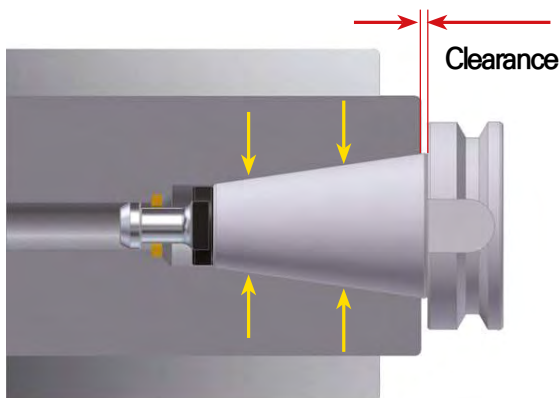

- The clearance between spindle and flange face

DBT Type

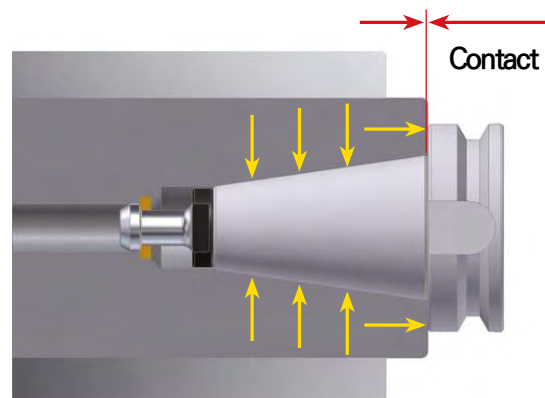

- Perfect face contact

Powerful clamping

Unlike BT, DBT shank has better clamping force because of contact both the taper and flange faces

Shank	External diameter of taper	External diameter of flange
BT30	$\varnothing 31.7 \rightarrow \varnothing 46$	
BT40	$\varnothing 44.4 \rightarrow \varnothing 63$	
BT50	$\varnothing 69.3 \rightarrow \varnothing 100$	

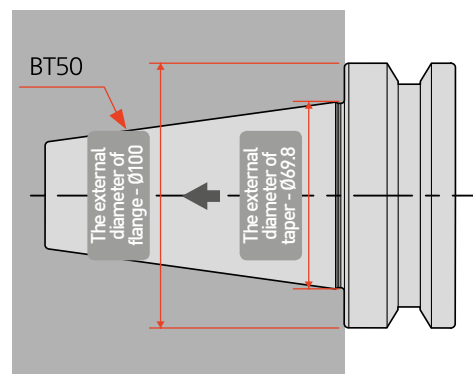

Difference between taper cross-section contact and flange external diameter contact, For high speed machining



HSK TOOLING SYSTEM

DIN69893-1, ISO12164-1:201

2 Face Constrained Tool holder

The 7/24 taper shank for multi-purpose has been pointed out that its performance is inappropriate in terms of repeatability, joint stiffness and high speed machining. Drawbacks of 7/24 taper shank had been eliminated by using new two face contact.

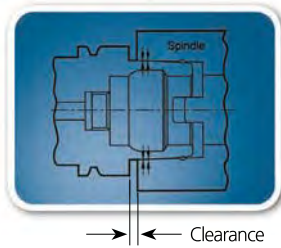

Elastic deformation of taper makes flange

Connecting

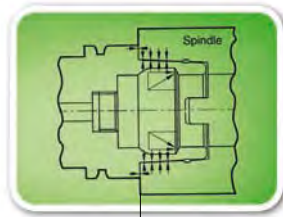

Perfect Face Contact

HSK shank -Perfect 2-surface constrained System



Excellent Repeatability – Run out Accuracy

As taper of holder elastically deform following the profile of the spindle shape, there is no eccentricity between the spindle and holder. Also, due to perfect face contacts between flange of the holder and spindle face, bending strength of the holder becomes very high, It decides run out accuracy.

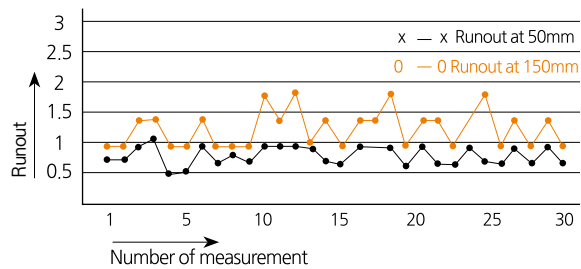
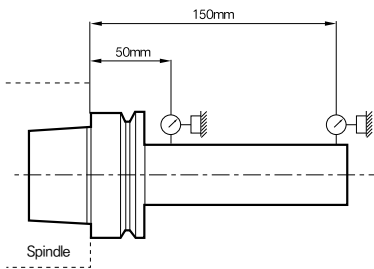

High Rigidity Against Bending Load

As taper of holder elastically deform following the profile of the spindle shape, there is no eccentricity between the spindle and holder. Also, due to perfect face contacts between flange of the holder and spindle face, bending strength of the holder becomes very high, It decides run out accuracy.

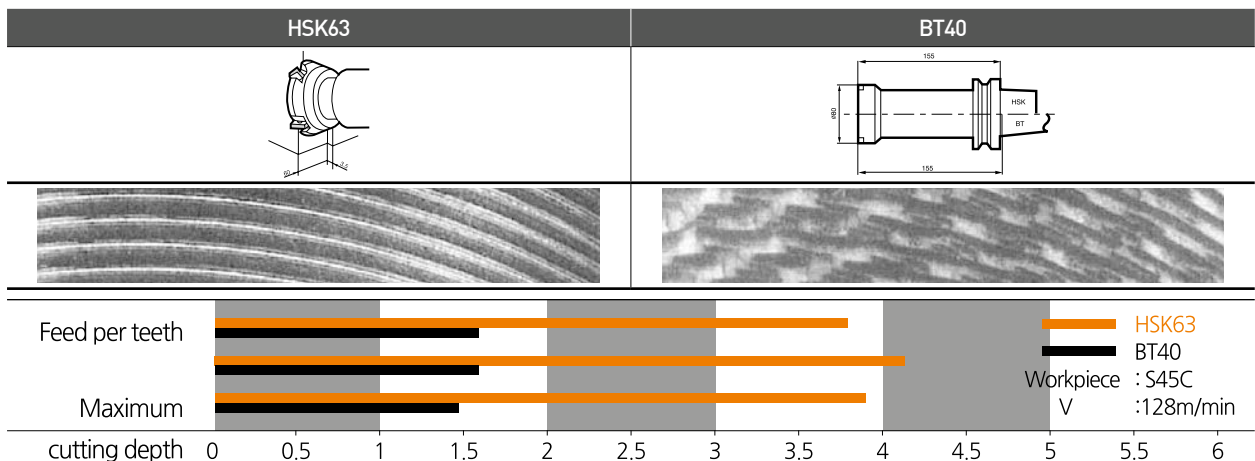











CATALOG MANUAL





NC TOTAL TOOLING SYSTEM

Significant Pictogram Description







Common pictogram

 G6.3 G value	Rotational durability value	 Ø25 Max Dia	Max. end mill diameter	 C Coolant System	Internal coolant system is basic
 15,000 Max RPM	Allowable rotation value	 130 MIN Range	Min. boring diameter	 C Coolant System	Internal coolant system is optional
 5µm Run-out	Vibration tolerance	 535 MAX Range	Max. boring diameter	 C Coolant System	This product does not support the internal coolant system

ISO Shank Specifications

 MAS 403-BT Shank	MAS403 specifications BT shank.
 DIN69871 -1A/B Shank	ISO 12164-1 : 2001 specifications HSK shank.
 DIN 69893-1 Shank	ISO 7388/1 : 1983(E) specifications SK shank.
 DIN2080 JISB6101 Shank	ISO 297 : 1988(E) specifications NT shank.

Insert

 0.3mm Max Depth Max. cutting depth	 Coating Coating insert	 Non-Coating Non-coating insert	Recommended machining grade
 K Cast iron	 H Heat-treated steel	 Sinter Alloy Sinter Alloy	

Intermittent Cutting Intensity

 Continuous	 Low interrupted	 Medium interrupted	 Heavy interrupted
-------------------------------------------------------------------------------------------------------	-------------------------------------------------------------------------------------------------------------	-----------------------------------------------------------------------------------------------------------------	----------------------------------------------------------------------------------------------------------------

Recommended Machining Works by Products

							
Facing	Drilling	Reaming	Milling	Chamfering	Tapping	Deburring	Boring

Angular Head Machining

					
Corner Rounding	Copy Machining	Slope Machining	Flank Machining	Free Angle	Inclined Face

Contact us as KakaoTalk



Run KakaoTalk

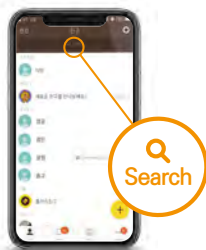

Click Find Friends

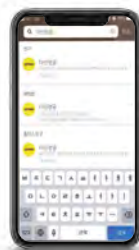

Search for "Dine Inc."

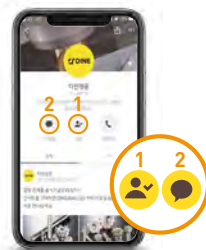

Start "1:1 Chatting" after adding friends



Make an inquiry



Chuck

DINOX NC TOTAL TOOLING SYSTEM

DHE/S	34
DHE	37
DHC Collet (Standard & Sealed Type)	45
DHJ Collet (Jet Coolant)	46
DZC	48
DSC	49
NPM	65
DCJ	67
DCS	76
DC	77
TC	78
DCL	79
DJT	81
SDC/PL	82
SDC/P	86
GERC	95
ER COLLET	100
ER/L	104
RTJW	106
DSK	108
GSK	112
HC COLLET	118
NPU	120
DTN	122
TCA	125
DST	126
TER	129
TEH	130
STER	133
OFH	134

1:1 CHAT



DHE/S

Slim hydraulic expansion chuck



Features

- Optimized chuck for machining that requires high-quality surface roughness and accuracy
- Suitable for challenging mold and automotive parts machining that involves complicated shapes and a lot of interferences
- Ideal for metal impeller machining, which requires deep penetration
- Enables easy tool connection without any additional connecting device
- Easy to perform fine boring operations (0.02–0.2mm)
- Application scope: milling, drilling, reaming

NAMING

BT30	DHE	8	S	115
Spindle	Hydraulic Expansion Chuck	Tool Dia.	Slim	Length



Recommended Machining Works

- Optimized for machining that requires high precision
- Enables challenging narrow and deep machining
- Products that require finishing



Product Comparison

- Length and thickness are the same as those of DSC/M TYPE (if the tool projection length is 40mm, difference of $\alpha =$ around 2°)
- Longer gauge line and higher rigidity (versus the DSC/M TYPE)
- Ideal for mold machining due to its 3-degree taper shape

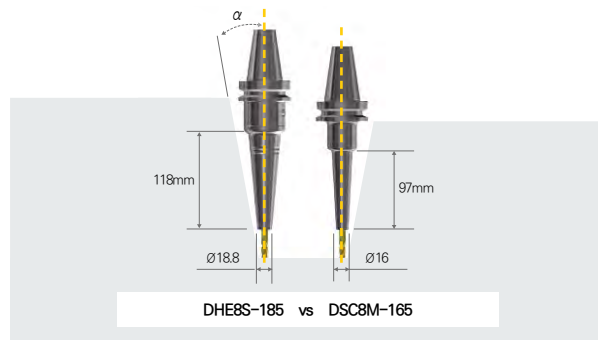

Stable Clamping force

- Maintains high clamping force and good accuracy by holding the tool at two points

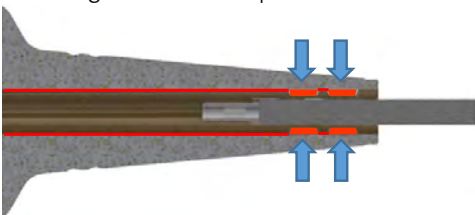

High-precision

- RUN OUT : below 5μ m (Long type 8μ m)
- $L = 3 \times \varnothing D$



1:1 CHAT



HSK-DHE/S

Slim hydraulic expansion chuck

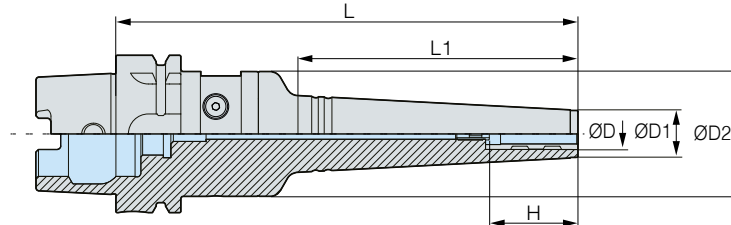

- : Stock
- H : Depth of tool insertion (Min. ~ Max.)
- C Internal coolant system is optional

- For more information on product features, see **34p**.
- For more information on the related parts, see **36p**.

	Designation	ØD	L	ØD1	ØD2	L1	H	RPM	Run-out (Based on 3D)	Kg	Package weight(Kg)	Stock
HSK63A	HSK63A-DHE6S-120	6	120	17	50	50	23	10,000	5µm	1.4	1.6	●
	HSK63A-DHE6S-185	6	185	17	50	115	23	10,000	8µm	1.7	1.9	●
	HSK63A-DHE8S-120	8	120	19	50	50	31	10,000	5µm	1.4	1.7	●
	HSK63A-DHE8S-185	8	185	19	50	115	31	10,000	8µm	1.8	2.0	●
	HSK63A-DHE10S-125	10	125	21	50	55	36	10,000	5µm	1.5	1.7	●
	HSK63A-DHE10S-185	10	185	21	50	115	36	10,000	8µm	1.8	2.0	●
	HSK63A-DHE12S-135	12	135	23	50	65	38	10,000	5µm	1.8	1.9	●
	HSK63A-DHE12S-185	12	185	23	50	115	38	10,000	8µm	1.8	2.1	●

(Unit : mm)

1:1 CHAT



DHE/S SPARE PART

Slim hydraulic expansion chuck related parts

SPARE PART	Type	Main component		Type	Main component	
		Clamp bolt	Wrench			Adjust screw
	Images			Images		
	Model No.			Model No.		
	BT30	DHE/S 6, 8, 10, 12	BTF1010	DHETW-5	DHE/S 6, 8, 10	DHE-M5 (ADJ)
	BT40	DHE/S 6, 8, 10, 12	BTF1010	DHETW-5	DHE/S 12	DHE-M10 (ADJ)
	HSK63A	DHE/S 6, 8, 10, 12	BTF1010	DHETW-5	DHE/S 12	DHE-M10 (ADJ)

SPARE PART	Type	Accessories
		Coolant tube for HSK
	Images	
	Model No.	
	HSK63A	HSK63A-CNS



DHE

Hydraulic expansion chuck



Features

- Ideal for machining on molds, automotive parts, and precision parts due to its high precision machining operations
- Improves machining surface roughness due to the effective vibration resistance of its hydraulic seal
- Reduces replacement time and operator fatigue because the tool is removable using a T-wrench
- Tool clamping range: $\varnothing 6\sim\varnothing 32$

NAMING

BT40	—	DHE	—	20	—	140
Spindle		Hydraulic Expansion Chuck		Tool dia.		Length

Product Features

Its high precision not only increases the tool life of a cutting tool by reducing the wear of the tool but also improves machining surface roughness with the effect of vibration reduction by its hydraulic seal.

Completely closed inside construction(durability)

- The completely closed system of its inner diameter prevents dust, cutting oil, lubricant, and chips, etc. from penetrating it.
- Maintains clamping force and precision for a long time

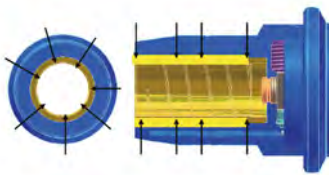

SHANK	GRADE	Max. RPM
BT50, SK50, HSK100A	G6.3	8,000
BT40, SK40, HSK63A	G6.3	10,000
BT30	G6.3	15,000



C Internal coolant system is basic (DBT, BT, SK Shank)

C Internal coolant system is optional (HSK Shank)

High precision

- Run-Out : below $5\mu\text{m}$
- $L = 3 \times \varnothing D$
- Shank : tolerance of $\varnothing D : h6$

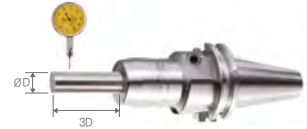

Removal availability by using T-wrench tool

- Clamping / unclamping structure that only requires simple operation (convenience)
 - : Reduces operator fatigue
 - : Enhances the operation rate of equipment



Stable clamping force

Provides clamping force by fixing the space of the holder and tool with hydraulic pressure



Chuck

Arbor/Modular

Boring tool

Angular head

CBN/PCD

TAUMAX

Other



DBT-DHE

Hydraulic expansion chuck



Fig.1

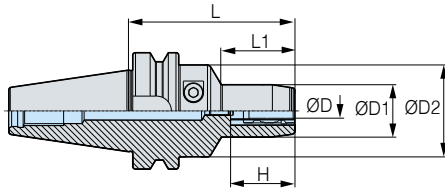
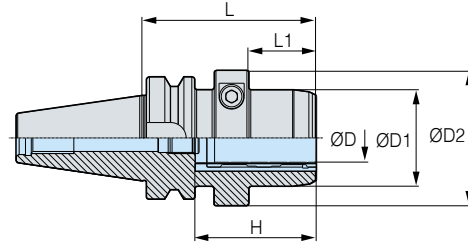

Fig.2



- : Stock
- H : Depth of tool insertion (Min. ~ Max.)

C Internal coolant system is basic

- For more information on product features, see **37p**.
- For more information on the related parts, see **46p**.

	Designation	ØD	L	ØD1	ØD2	L1	H	ADJ	Fig.	Kg	Package weight(Kg)	Stock	
DBT30	DBT30-DHE6-65	6	65	29	46	33	30~40	M5	1	0.7	0.8		
	DBT30-DHE8-65	8	65	31	46	33	30~40	M5	1	0.7	0.8		
	DBT30-DHE10-65	10	65	32	46	34	35~45	M5	1	0.7	0.8		
	DBT30-DHE12-70	12	70	35	46	34	41~51	M5	1	0.8	0.8		
	DBT30-DHE14-90	14	90	36	46	40	43~53	M5	1	1	1.1		
	DBT30-DHE16-90	16	90	40	46	45	46~56	M5	1	1	1.1		
	DBT30-DHE18-90	18	90	42	46	40	49~59	M5	1	1.1	1.2		
	DBT30-DHE20-90	20	90	44	46	45	49~59	M5	1	1.1	1.2	●	
DBT40	DBT40-DHE6-90	6	90	29	50	40	30~40	M5	1	1.4	1.6	●	
	DBT40-DHE6-140	6	140	29	50	40	30~40	M5	1	2.2	2.5		
	DBT40-DHE8-90	8	90	31	50	40	30~40	M5	1	1.4	1.6	●	
	DBT40-DHE8-140	8	140	31	50	40	30~40	M5	1	2.2	2.5		
	DBT40-DHE10-90	10	90	33	50	40	35~45	M5	1	1.5	1.7	●	
	DBT40-DHE10-140	10	140	33	50	40	35~45	M5	1	2.2	2.4		
	DBT40-DHE12-90	12	90	35	50	40	41~51	M10	1	1.5	1.7	●	
	DBT40-DHE12-140	12	140	35	50	40	41~51	M10	1	2.3	2.5		
	DBT40-DHE14-90	14	90	36	50	40	43~53	M10	1	1.5	1.7	●	
	DBT40-DHE14-140	14	140	36	50	40	43~53	M10	1	2.2	2.4		
	DBT40-DHE16-90	16	90	40	50	45	46~56	M10	1	1.5	1.7	●	
	DBT40-DHE16-140	16	140	40	50	45	46~56	M10	1	2.2	2.5		
	DBT40-DHE18-90	18	90	42	50	45	49~59	M10	1	1.5	1.7	●	
	DBT40-DHE18-140	18	140	42	50	45	49~59	M10	1	2.2	2.5		
	DBT40-DHE20-90	20	90	44	50	47	49~59	M10	1	1.5	1.7	●	
	DBT40-DHE20-140	20	140	44	50	50	49~59	M10	1	2.3	2.5		
	DBT40-DHE25-90	25	90	50	70	35	58~68	M16	2	2	2.2	●	
	DBT40-DHE32-90	32	90	63	75	35	58~68	M16	2	2.3	2.5	●	

(Unit : mm)



BT-DHE

Hydraulic expansion chuck



MAS 403-BT
G6.3
15,000
5 μ m
C
Milling
Reaming
Chamfering

Fig.1

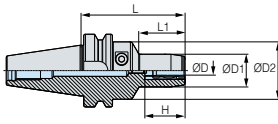

Fig.2

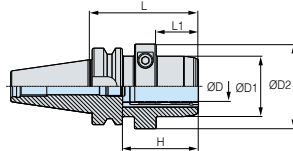

Fig.3

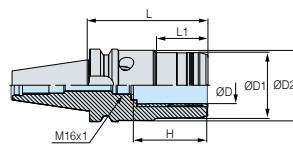
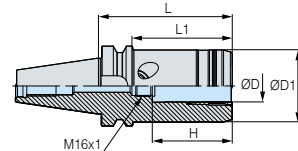

Fig.4



- : Stock
- H : Depth of tool insertion (Min. ~ Max.)

C Internal coolant system is basic

- For more information on product features, see **37p**.
- For more information on the related parts, see **46p**.

	Designation	ØD	L	ØD1	ØD2	L1	H	ADJ	Fig.	Kg	Package weight(Kg)	Stock
BT30	BT30-DHE4-65	4	65	29	46	33	40	-	1	0.7	0.8	●
	BT30-DHE5-65	5	65	29	46	33	40	-	1	0.7	0.8	●
	BT30-DHE6-65	6	65	29	46	33	30~40	M5	1	0.7	0.8	●
	BT30-DHE8-65	8	65	31	46	33	30~40	M5	1	0.7	0.8	●
	BT30-DHE10-65	10	65	32	46	34	35~45	M5	1	0.7	0.8	●
	BT30-DHE12-70	12	70	35	46	34	36~46	M5	1	0.8	0.8	●
	BT30-DHE14-90	14	90	36	46	40	43~53	M5	1	1.0	1.1	●
	BT30-DHE16-90	16	90	40	46	45	46~56	M5	1	1.0	1.1	●
	BT30-DHE18-90	18	90	42	46	40	49~59	M5	1	1.1	1.2	●
BT30-DHE20-90	20	90	44	46	45	49~59	M5	1	1.1	1.2	●	
BT40	BT40-DHE4-90	4	90	29	50	40	40	-	1	1.4	1.6	●
	BT40-DHE5-90	5	90	29	50	40	40	-	1	1.4	1.6	●
	BT40-DHE6-90	6	90	29	50	40	30~40	M5	1	1.4	1.6	●
	BT40-DHE6-140	6	140	29	50	40	30~40	M5	1	2.2	2.5	●
	BT40-DHE8-90	8	90	31	50	40	30~40	M5	1	1.4	1.6	●
	BT40-DHE8-140	8	140	31	50	40	30~40	M5	1	2.2	2.5	●
	BT40-DHE10-90	10	90	33	50	40	35~45	M5	1	1.5	1.7	●
	BT40-DHE10-140	10	140	33	50	40	35~45	M5	1	2.2	2.4	●
	BT40-DHE12-90	12	90	35	50	40	41~51	M10	1	1.5	1.7	●
	BT40-DHE12-140	12	140	35	50	40	41~51	M10	1	2.3	2.5	●
	BT40-DHE14-90	14	90	36	50	40	43~53	M10	1	1.5	1.7	●
	BT40-DHE14-140	14	140	36	50	40	43~53	M10	1	2.2	2.4	●
	BT40-DHE16-90	16	90	40	50	45	46~56	M10	1	1.5	1.7	●
	BT40-DHE16-140	16	140	40	50	45	46~56	M10	1	2.2	2.5	●
	BT40-DHE18-90	18	90	42	50	45	49~59	M10	1	1.5	1.7	●
	BT40-DHE18-140	18	140	42	50	45	49~59	M10	1	2.2	2.5	●
	BT40-DHE20-90	20	90	44	50	47	49~59	M10	1	1.5	1.7	●
	BT40-DHE20-140	20	140	44	50	50	49~59	M10	1	2.3	2.5	●
	BT40-DHE25-90	25	90	50	70	35	58~68	M16	2	2.0	2.2	●
	BT40-DHE25-105	25	105	57	-	78	51~61	M16	4	2.0	2.2	●
	BT40-DHE25-140	25	140	57	-	113	51~61	M16	4	2.6	2.9	●
	BT40-DHE32-90	32	90	63	75	35	58~68	M16	2	2.3	2.5	●
	BT40-DHE32-105	32	105	57	61	45	55~65	M16	3	2.4	2.6	●
	BT40-DHE32-140	32	140	57	61	45	55~65	M16	3	3.0	3.2	●

(Unit : mm)



BT-DHE

Hydraulic expansion chuck



MAS 403-BT	G6.3	15,000	5μm	C	Milling	Reaming	Chamfering
Shank	G value	Max RPM	Run-out	Coolant System			

Fig.1

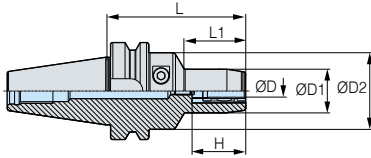

Fig.2

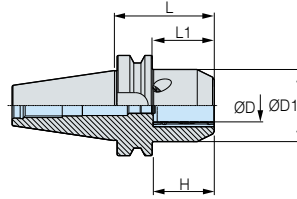
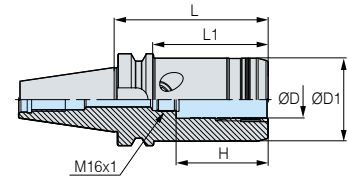

Fig.3



- : Stock
- H : Depth of tool insertion (Min. ~ Max.)

C Internal coolant system is basic

- For more information on product features, see **37p**
- For more information on the related parts, see **46p**

	Designation	ØD	L	ØD1	ØD2	L1	H	ADJ	Fig.	Kg	Package weight(Kg)	Stock
BT50	BT50-DHE4-90	4	90	29	50	34	40	-	1	3.9	4.2	●
	BT50-DHE5-90	5	90	29	50	34	40	-	1	3.9	4.2	●
	BT50-DHE6-90	6	90	29	50	34	30~40	M5	1	3.9	4.2	●
	BT50-DHE6-140	6	140	29	50	40	30~40	M5	1	4.4	4.8	●
	BT50-DHE8-90	8	90	31	50	34	30~40	M5	1	4.2	4.5	●
	BT50-DHE8-140	8	140	31	50	40	30~40	M5	1	4.6	5.0	●
	BT50-DHE10-90	10	90	33	50	34	35~45	M5	1	3.9	4.2	●
	BT50-DHE10-140	10	140	33	50	34	35~45	M5	1	4.5	4.9	●
	BT50-DHE12-90	12	90	35	50	34	41~51	M10	1	4.0	4.3	●
	BT50-DHE12-140	12	140	35	50	34	41~51	M10	1	4.6	5.0	●
	BT50-DHE14-90	14	90	36	50	34	43~53	M10	1	3.9	4.2	●
	BT50-DHE14-140	14	140	36	50	34	43~53	M10	1	4.5	4.9	●
	BT50-DHE16-90	16	90	40	50	34	46~56	M10	1	4.1	4.4	●
	BT50-DHE16-140	16	140	40	50	34	46~56	M10	1	4.7	5.1	●
	BT50-DHE18-90	18	90	42	50	40	49~59	M10	1	4.0	4.3	●
	BT50-DHE18-140	18	140	42	50	45	49~59	M10	1	4.5	4.9	●
	BT50-DHE20-90	20	90	44	50	34	49~59	M10	1	4.0	4.3	●
	BT50-DHE20-140	20	140	44	50	47	49~59	M10	1	4.5	4.9	●
BT50-DHE25-90	25	90	66	-	52	58~68	M16	2	4.7	5.0	●	
BT50-DHE25-150	25	150	57	-	112	51~61	M16	3	4.5	4.8	●	
BT50-DHE32-90	32	90	72	-	52	58~68	M16	2	5.8	6.2	●	

(Unit : mm)

Chuck

Arbor/Modular

Boring tool

Angular head

CBN/PCD

TAUMAX

Other

1:1 CHAT



HSK-DHE

Hydraulic expansion chuck

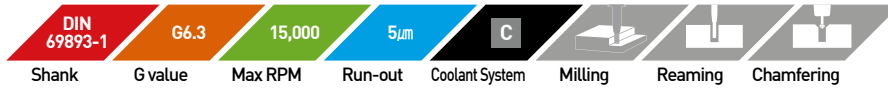

Fig.1

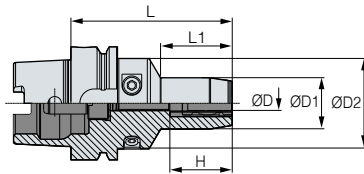
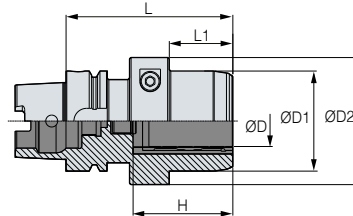

Fig.2



- : Stock
- H : Depth of tool insertion (Min. ~ Max.)

C Internal coolant system is optional

	Designation	ØD	L	ØD1	ØD2	L1	H	ADJ	RPM	Fig.	Kg	Package weight(Kg)	Stock
HSK50A	HSK50A-DHE6-70	6	70	29	40	28	30~40	M5	15,000	1	0.7	0.8	
	HSK50A-DHE8-70	8	70	31	40	28	30~40	M5	15,000	1	0.7	0.9	
	HSK50A-DHE10-80	10	80	33	40	35	35~45	M5	15,000	1	0.8	0.9	
	HSK50A-DHE12-90	12	90	35	40	40	41~51	M5	15,000	1	0.8	1	
	HSK50A-DHE14-95	14	95	36	53	28	43~53	M10	15,000	2	0.8	1.2	
	HSK50A-DHE16-95	16	95	40	53	28	46~56	M10	15,000	2	0.9	1.3	
	HSK50A-DHE18-100	18	100	42	60	28	49~59	M10	15,000	2	0.9	1.4	
	HSK50A-DHE20-100	20	100	44	60	28	49~59	M10	15,000	2	0.9	1.5	
HSK63A	HSK63A-DHE4-75	4	75	29	50	34	40	-	10,000	1	1	1.2	●
	HSK63A-DHE5-75	5	75	29	50	34	40	-	10,000	1	1	1.2	●
	HSK63A-DHE6-75	6	75	29	50	34	30~40	M5	10,000	1	1	1.2	●
	HSK63A-DHE6-150	6	150	29	50	34	30~40	M5	10,000	1	2.2	2.4	
	HSK63A-DHE8-75	8	75	31	50	34	30~40	M5	10,000	1	1	1.2	●
	HSK63A-DHE8-150	8	150	31	50	34	30~40	M5	10,000	1	2.2	2.4	
	HSK63A-DHE10-85	10	85	33	50	34	35~45	M5	10,000	1	1.2	1.4	●
	HSK63A-DHE10-150	10	150	33	51	34	35~45	M5	10,000	1	2.2	2.4	●
	HSK63A-DHE12-90	12	90	35	51	40	41~51	M10	10,000	1	1.2	1.4	●
	HSK63A-DHE12-150	12	150	35	51	40	41~51	M10	10,000	1	2.2	2.4	●
	HSK63A-DHE14-95	14	95	36	52	40	42~53	M10	10,000	1	1.3	1.5	
	HSK63A-DHE14-150	14	150	36	52	40	43~53	M10	10,000	1	2.2	2.4	
	HSK63A-DHE16-95	16	95	40	52	45	46~56	M10	10,000	1	1.3	1.5	●
	HSK63A-DHE16-150	16	150	40	53	45	46~56	M10	10,000	1	2.2	2.4	
	HSK63A-DHE18-100	18	100	42	53	45	49~59	M10	10,000	1	1.4	1.7	
	HSK63A-DHE18-150	18	150	42	53	45	49~59	M10	10,000	1	2.2	2.4	
	HSK63A-DHE20-100	20	100	44	50	50	49~59	M10	10,000	1	1.4	1.7	●
	HSK63A-DHE20-150	20	150	44	50	50	49~59	M10	10,000	1	2.2	2.4	●
	HSK63A-DHE25-110	25	110	50	70	48	56~68	M16	10,000	2	1.9	2.1	●
	HSK63A-DHE32-110	32	110	63	80	48	56~68	M16	10,000	2	2.3	2.5	●

(Unit : mm)



HSK-DHE

Hydraulic expansion chuck

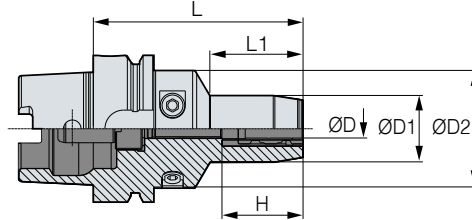
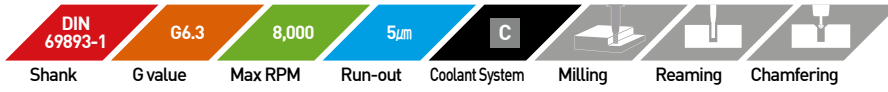

- : Stock
- H : Depth of tool insertion (Min. ~ Max.)
- C Internal coolant system is optional

- For more information on product features, see **37p**
- For more information on the related parts, see **46p**

	Designation	ØD	L	ØD1	ØD2	L1	H	ADJ	RPM	Fig.	Kg	Package weight(Kg)	Stock
HSK100A	HSK100A-DHE6-80	6	80	29	50	34	30~40	M5	8,000	1	2.4	2.6	●
	HSK100A-DHE6-150	6	150	29	50	34	30~40	M5	8,000	1	2.8	3	
	HSK100A-DHE8-80	8	80	31	50	34	30~40	M5	8,000	1	2.4	2.6	●
	HSK100A-DHE8-150	8	150	31	50	34	30~40	M5	8,000	1	2.8	3	
	HSK100A-DHE10-90	10	90	33	50	34	35~45	M5	8,000	1	2.5	2.7	
	HSK100A-DHE10-150	10	150	33	50	34	35~45	M5	8,000	1	3	3.2	
	HSK100A-DHE12-95	12	95	35	50	34	41~51	M10	8,000	1	2.5	2.7	
	HSK100A-DHE12-150	12	150	35	50	34	41~52	M10	8,000	1	3	3.2	
	HSK100A-DHE14-100	14	100	36	50	40	43~53	M10	8,000	1	2.6	2.8	
	HSK100A-DHE14-150	14	150	36	50	40	43~54	M10	8,000	1	3.1	3.3	
	HSK100A-DHE16-100	16	100	40	50	45	46~56	M10	8,000	1	2.6	2.8	
	HSK100A-DHE16-150	16	150	40	50	45	46~56	M10	8,000	1	3.1	3.3	
	HSK100A-DHE18-100	18	100	42	50	45	49~59	M10	8,000	1	2.7	2.9	
	HSK100A-DHE18-150	18	150	42	50	45	49~59	M10	8,000	1	3.2	3.4	
	HSK100A-DHE20-105	20	105	44	50	50	49~59	M10	8,000	1	2.8	3	●
	HSK100A-DHE20-150	20	150	44	50	50	49~59	M10	8,000	1	3.4	3.6	
HSK100A-DHE25-115	25	115	50	63	62	58~68	M16	8,000	1	3.3	3.5	●	
HSK100A-DHE32-115	32	115	63	75	62	58~68	M16	8,000	1	3.8	4	●	

(Unit : mm)

Accessories

SPARE PART	Type	Accessories
	Images	
	Model No.	
	HSK50A	HSK50A-CNS
	HSK63A	HSK63A-CNS
	HSK100A	HSK100A-CNS



DHC Collet (Standard & Sealed type)

DHE collet(Standard type) / DHE collet(Sealed type)



Fig.1

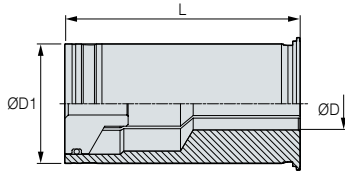
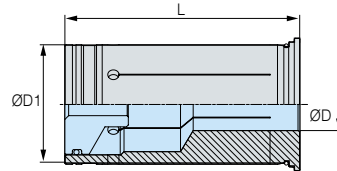

Fig.2



● : Stock

c This product does not support the internal coolant system

	Designation (Standard type)	ØD	L	ØD1	Fig.	Kg	Stock
DHC12	DHC12-3	3	47	12	1	0.06~0.08	●
	DHC12-4	4	47	12	1	0.06~0.08	●
	DHC12-5	5	47	12	1	0.06~0.08	●
	DHC12-6	6	47	12	1	0.06~0.08	●
	DHC12-8	8	47	12	1	0.06~0.08	●
DHC20	DHC20-3	3	52	20	1	0.04~0.06	●
	DHC20-4	4	52	20	1	0.04~0.06	●
	DHC20-5	5	52	20	1	0.04~0.06	●
	DHC20-6	6	52	20	1	0.04~0.06	●
	DHC20-7	7	52	20	1	0.04~0.06	●
	DHC20-8	8	52	20	1	0.04~0.06	●
	DHC20-9	9	52	20	1	0.04~0.06	●
	DHC20-10	10	52	20	1	0.04~0.06	●
	DHC20-11	11	52	20	1	0.04~0.06	●
	DHC20-12	12	52	20	1	0.04~0.06	●
	DHC20-14	14	52	20	1	0.04~0.06	●
	DHC20-16	16	52	20	1	0.04~0.06	●
DHC32	DHC32-6	6	63	32	1	0.2~0.5	●
	DHC32-8	8	63	32	1	0.2~0.5	●
	DHC32-10	10	63	32	1	0.2~0.5	●
	DHC32-12	12	63	32	1	0.2~0.5	●
	DHC32-14	14	63	32	1	0.2~0.5	●
	DHC32-16	16	63	32	1	0.2~0.5	●
	DHC32-18	18	63	32	1	0.2~0.5	●
	DHC32-19	19	63	32	1	0.2~0.5	●
	DHC32-20	20	63	32	1	0.2~0.5	●
	DHC32-25	25	63	32	1	0.2~0.5	●

※ Other sizes are customizable.

(Unit : mm)

● : Stock

c Internal coolant system is basic

	Designation (Sealed type)	ØD	L	ØD1	Fig.	Kg	Stock
DHC12	DHC12-3(P)	3	47	12	2	0.04	●
	DHC12-4(P)	4	47	12	2	0.04	●
	DHC12-5(P)	5	47	12	2	0.04	●
	DHC12-6(P)	6	47	12	2	0.04	●
	DHC12-8(P)	8	47	12	2	0.04	●
DHC20	DHC20-3(P)	3	52	20	2	0.06~0.1	●
	DHC20-4(P)	4	52	20	2	0.06~0.1	●
	DHC20-5(P)	5	52	20	2	0.06~0.1	●
	DHC20-6(P)	6	52	20	2	0.06~0.1	●
	DHC20-7(P)	7	52	20	2	0.06~0.1	●
	DHC20-8(P)	8	52	20	2	0.06~0.1	●
	DHC20-9(P)	9	52	20	2	0.06~0.1	●
	DHC20-10(P)	10	52	20	2	0.06~0.1	●
	DHC20-11(P)	11	52	20	2	0.06~0.1	●
	DHC20-12(P)	12	52	20	2	0.06~0.1	●
	DHC20-14(P)	14	52	20	2	0.06~0.1	●
	DHC20-16(P)	16	52	20	2	0.06~0.1	●
DHC32	DHC32-6(P)	6	63	32	2	0.2~0.3	●
	DHC32-8(P)	8	63	32	2	0.2~0.3	●
	DHC32-10(P)	10	63	32	2	0.2~0.3	●
	DHC32-12(P)	12	63	32	2	0.2~0.3	●
	DHC32-14(P)	14	63	32	2	0.2~0.3	●
	DHC32-16(P)	16	63	32	2	0.2~0.3	●
	DHC32-18(P)	18	63	32	2	0.2~0.3	●
	DHC32-19(P)	19	63	32	2	0.2~0.3	●
	DHC32-20(P)	20	63	32	2	0.2~0.3	●
	DHC32-25(P)	25	63	32	2	0.2~0.3	●

※ Other sizes are customizable.

(Unit : mm)

Chuck

Arbor/Modular

Boring tool

Angular head

CBN/PCD

TAUMAX

Other

1:1 CHAT



DHJ Collet (Jet coolant)

DHJ Jet coolant collet

3 μ m

C

Run-out

Coolant System

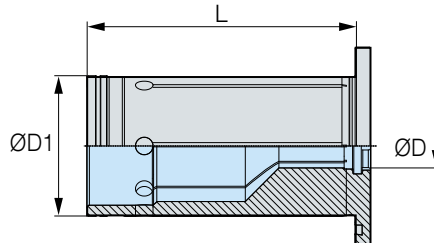

● : Stock

C Internal coolant system is basic

	Designation	ØD	L	ØD1	Kg	Package weight(Kg)	Stock
DHJ20	DHJ20-6	6	50	20	0.1	0.1	●
	DHJ20-8	8	50	20	0.1	0.1	●
	DHJ20-10	10	50	20	0.1	0.1	●
	DHJ20-12	12	50	20	0.1	0.1	●
	DHJ20-14	14	50	20	0.08	0.08	●
	DHJ20-16	16	50	20	0.08	0.08	●

(Unit : mm)

1:1 CHAT



DHE SPARE PART

Hydraulic expansion chuck parts

SPARE PART	Type	Main component	
		Clamp bolt	Wrench
	Images		
	Model No.		
	BT30 / SK30 / HSK50A	DHE 6, 8, 10, 12, 14, 16, 18, 20	BTF1010 DHETW-5
	BT40 / BT50 / SK40 / SK50 / HSK63A / HSK100A	DHE 6, 8, 10, 12, 14, 16, 18, 20	BTF1010 DHETW-5
		DHE 25, 32	BTF1212-1.5 DHETW-6

SPARE PART	Type	Main component
		Adjustment screw
	Images	
	Model No.	
	DHE 6, 8, 10	DHE-M5 (ADJ)
	DHE 12, 14, 16, 18, 20	DHE-M10 (ADJ)
	DHE 25, 32	DHE-M16 (ADJ)

※ DBT30, BT30, HSK50A is Exception



DZC

Zero fit collet



Features

Correcting 10 – 20μm runout generated at tool tip to 0–2μm.

- Improves the runout and straightness of end tools.
- Improves the surface roughness and quality of the machining area.
- Improves the accuracy of boring hole dimension.
- Improves the tool life of end tools.

NAMING

DZC	20	—	10
Zero fit collet	Collet size		Tool dia.



Product Features

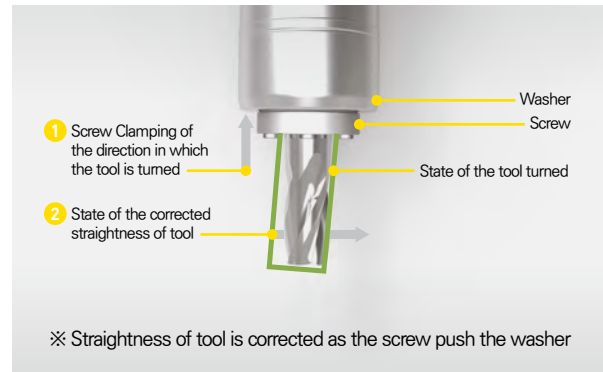
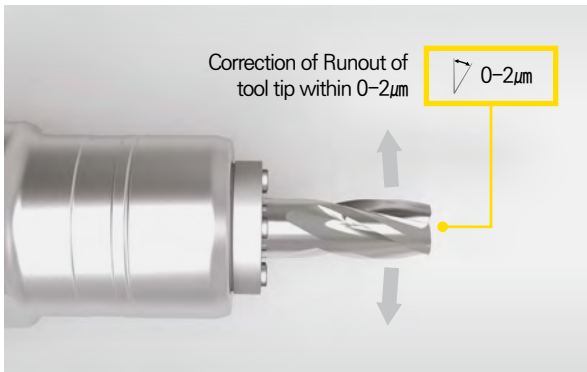

Comparison test

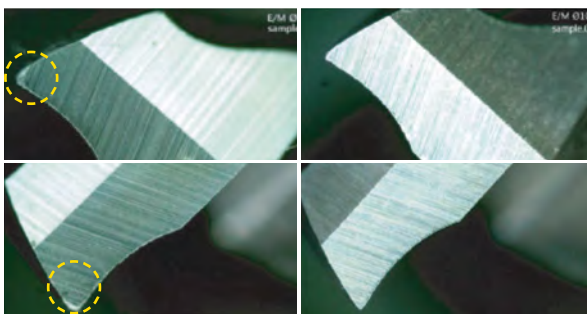
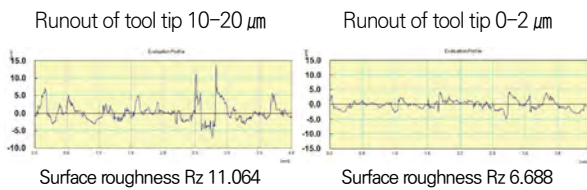

PCD reamer hole machining test result

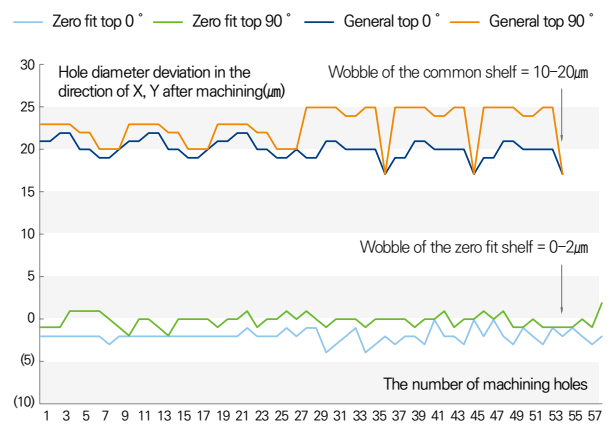

Hole actual deviation as Machining result(mm)		
Based on Ø8	Zero Fit	General
	+0.003	+0.02

Chuck

Arbor/Modular

Boring tool

Angular head

CBN/PCD

TAUMAX

Other



DSC

Shrinking chuck



G2.5	25,000	3 μ m	C				
G value	Max RPM	Run-out	Coolant System	Milling	Drilling	Reaming	Chamfering

Features

- Uses special steel specially heat-treated
- Enables anyone to perform high-precision tightening and machining
- Ensure a long tool life and enhanced machining accuracy by minimizing interference and tool protrusion length for deep groove machining
- Clamping range : $\varnothing 3\sim\varnothing 20$



NAMING	BT50	DSC	6	S	140	S
	Shank shape BT, HSK, SK, ST, CS, CM	Holder type DSC:Shrinking chuck SLK:2piece holder	Tool dia.	Type S: Slim M: Middle NON: General	Length	Special S: Curve type NON: General

High clamping force

- Increase of 30% clamping force versus hydraulic expansion chuck
- Definite power transmission
- Runout ($\leq 0.003\text{mm}$)

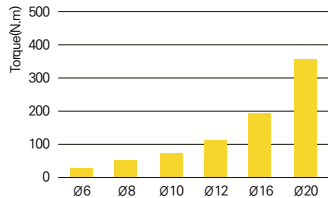

Symmetrical design



Shrinking Chuck	Collet Chuck
Fix the space between the holder and tool as the heat contraction	Fix the tool using elasticity of the collet
Heat expansion \blacktriangleright heat contraction	Elastic strain
Very high clamping force	High clamping force

Slim type series

Straight Type

Used by combining with various holders such as hydraulic expansion chuck, milling chuck, and collet chuck



Mono Type

Used with high precision as integral types



2 Piece Type

Holder + collet connection shape
Connecting the holder and collet by the bolt tightening method



1:1 CHAT



DSC

Shrinking chuck



Tool tightening tolerance

Tool Shank	Tool Shank Tolerance[h6]	Tool Shank	Tool Shank Tolerance[h6]	Tool Shank	Tool Shank Tolerance[h6]	Tool Shank	Tool Shank Tolerance[h6]
Ø3	0 ~ -0.008	Ø6	0 ~ -0.008	Ø12	0 ~ -0.011	Ø25	0 ~ -0.013
Ø4	0 ~ -0.009	Ø8	0 ~ -0.009	Ø16	0 ~ -0.011	Ø32	0 ~ -0.016
Ø5	0 ~ -0.011	Ø10	0 ~ -0.011	Ø20	0 ~ -0.013		

(Unit : mm)

Min. tool insertion depth

Inner diameter[Ø]	Type	Ø6	Ø8	Ø10	Ø12	Ø16	Ø20	Ø25	Ø32
Min. tool insertion depth	Slim	18	24	30	30	-	-	-	-
	Medium	18	24	30	30	32	40	-	-
	General	26	26	32	37	37	40	42	52

(Unit : mm)

DSC MAP

Shrinking Chuck

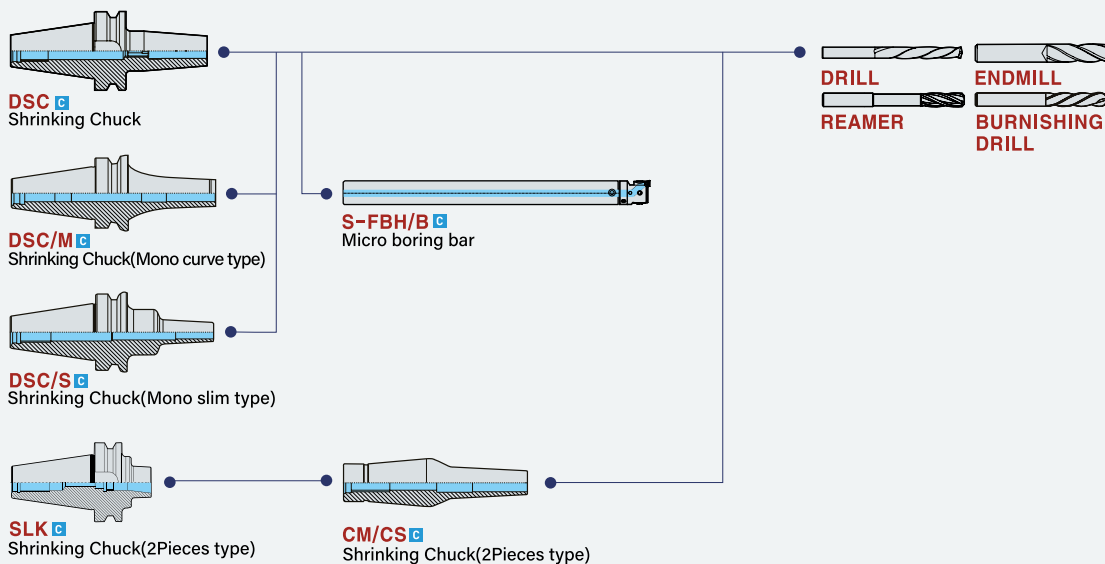



DSC

Shrinking chuck



Mono Curve Type

- Integral DSC of outstanding accuracy and rigidity balance characteristics
- Long but rigid holder design



2 Piece Type

2Piece types enable various machining operations by collet replacement and provide convenience in tool management and use based on easy and fast assembly using tightening bolts.

Shape	Accuracy	Type	
		<p>Slim type</p>	<p>Medium type</p>
Holder+collet connection shape Connecting the holder and collet by the bolt tightening method			

Various collet shapes – 28 in total	Coolant system
<p>Tool management and purchase expenses are reduced by changing and using only collet in one body</p>	<p>Coolant type 60-degree angle adjustable</p>

Chuck

Arbor/Modular

Boring tool

Angular head

CBN/PCD

TAUMAX

Other



Mono Type

Shape	Accuracy	Type	
		<p>Slim type</p>	<p>Medium type</p>

- Ensures good rigidity by using special steel instead of general steel and maintains high precision due to its excellent thermal resistance even when it is used more than 5,000 times.
- Enables stable cutting and good surface roughness due to its high rigidity
- Provides a long tool life due to its high precision

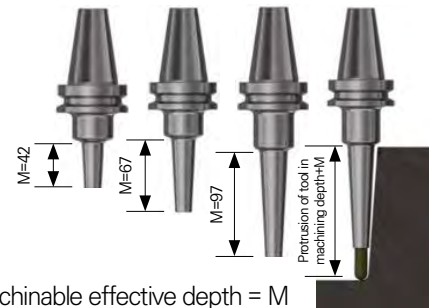

Straight Type

Shape	Accuracy	Type	
		<p>Slim type</p>	<p>Medium type</p>
		Used by combining with various holders such as hydraulic expansion chuck, milling chuck, and collet chuck, etc.	

- Straight types used by combining with various holders such as hydraulic expansion chuck and collet chuck, etc. maintain high precision and help enable various machining operations at an affordable price.
- There are 20 types of shanks that can be used according to work situations

Examples



Ø6-Ø12 tools can be tightened
Various lengths and shank sizes



Lengths can be adjusted and used
according to machining situations



DSC

Shrinking chuck



Chuck

Arbor/Modular

Boring tool

Angular head

CBN/PCD

TAUMAX

Other

Adjustment method of tool insertion depth

1. Prepare a $\varnothing 5$ Pin suitable for tool length
2. Combine the $\varnothing 5$ Pin and adjustment handler and fix them with a clamp bolt
3. Fix the fixing guide to the tool and put the tightened adjustment handler therein.
4. Put it on the tool stand and measure tool insertion depth

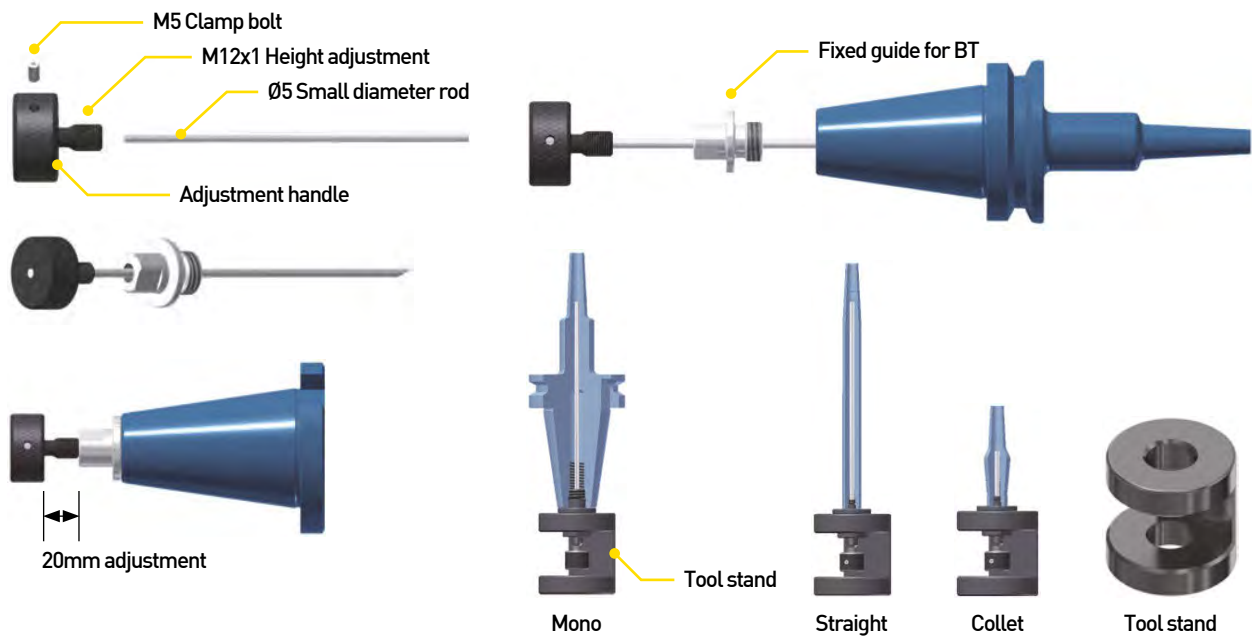

Accessories

Name	Designation
Adjustment handler	CTH-01

Name	Designation	$\varnothing 5$	L	H	M
Fixing guide	SG-M10	25	25	10	M10
	SG-M12	25	25	12	M12
	SG-M16	25	25	14	M16
	SG-M24	25	25	20	M24

Name	Designation
Tool Stand	TS-DSC

Name	Designation
$\varnothing 5$ Small-diameter rod	Individual purchase

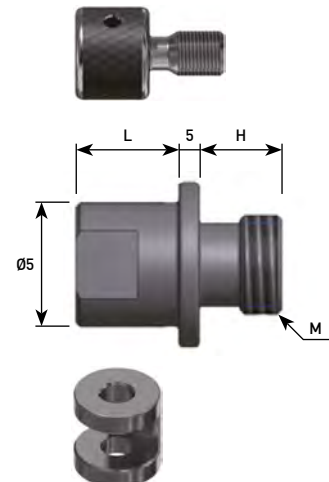



DSC

Shrinking chuck



Precautions for use

Tools to use

- Use cemented carbide tools.
- High-speed-steel may not be disassembled.
- Using an excessive tolerance tool affects clamping force, causing an accident.

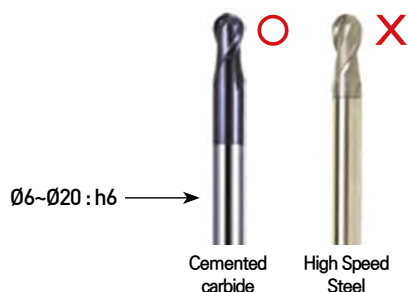

High-frequency heating precautions

- When tightening/disassembling a tool, it is recommended that slim-type programmed shrink fit devices be used.
- Using devices with no slim-type program may cause overheating. (Overheating may affect the product durability, service life, and accuracy.)

Precautions in case of tightening a tool

- Maintain clean state by removing rust, dust, cutting oil, etc. generated by corrosion of the inner diameter of the chuck before tool tightening.
- When tightening a tool, tighten it under the tightening section.
- Tool tightening in the middle of the tightening section affects accuracy and durability.
- When tightening a tool, touching the bottom surface affects accuracy.

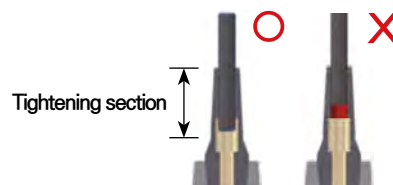

Storage method

- When the shrink fit chuck is not used, the tool should be separated from the chuck. (Long-time connection may affect the service life of the product.)
- After using the shrink fit chuck, be sure to remove moisture and use inhibited oil and rust-preventing spray to prevent rust from occurring. (Less rust occurs compared to general steel as special steel is used; however, long-time non-use may cause rust occurrence.)

Components for separate sale

Shrinking Device

TAUMAX shrink fit equipment MH-200

- Enables a maximum of 30-time consecutive heating
- Enables the common use of steel, SUS material holders
- Enables the use of all standard taper tools simply by adapter flange replacement
- Enables replacement of heating coils with diameters of Ø25, Ø30, Ø40, Ø55
- Enables chuck overheating prevention and manual tool cooling through setting

※ For more information on product features, see **301p**.





BT-DSC

Shrinking chuck

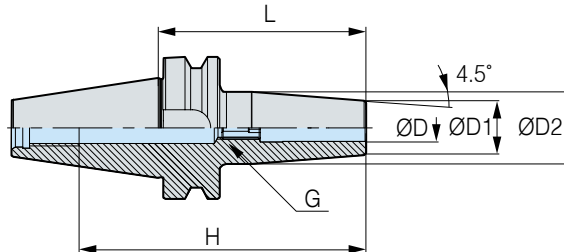

- : To be discontinued
- : Stock
- H : Depth of tool insertion

C Internal coolant system is basic

• For more information on product features, see **49p**

• For more information on the related parts (adjustment screw), see **64p**

	Designation	ØD	L	ØD1	ØD2	H	G	RPM	Kg	Package weight(Kg)	Stock
BT30	BT30-DSC3-60	3	60	11	19	82	-	25,000	0.4	0.5	●
	BT30-DSC4-60	4	60	13	21	82	-	25,000	0.4	0.5	●
BT40	BT40-DSC6-90	6	90	21	27	36	M5	20,000	1.1	1.3	●
	BT40-DSC6-120	6	120	21	27	36	M5	20,000	1.2	1.5	●
	BT40-DSC6-160	6	160	21	27	36	M5	20,000	1.4	1.7	●
	BT40-DSC8-90	8	90	21	27	36	M5	20,000	1.1	1.3	●
	BT40-DSC8-120	8	120	21	27	36	M5	20,000	1.2	1.4	●
	BT40-DSC8-160	8	160	21	27	36	M5	20,000	1.4	1.7	●
	BT40-DSC10-90	10	90	24	32	42	M8	20,000	1.1	1.3	●
	BT40-DSC10-120	10	120	24	32	42	M8	20,000	1.3	1.6	●
	BT40-DSC10-160	10	160	24	32	42	M8	20,000	1.6	1.8	●
	BT40-DSC12-90	12	90	24	32	47	M8	20,000	1.1	1.3	●
	BT40-DSC12-120	12	120	24	32	47	M8	20,000	1.3	1.5	●
	BT40-DSC12-160	12	160	24	32	47	M8	20,000	1.6	1.8	●
	BT40-DSC16-90	16	90	27	34	50	M12	20,000	1.2	1.4	●
	BT40-DSC16-120	16	120	27	34	50	M12	20,000	1.3	1.6	●
	BT40-DSC16-160	16	160	27	34	50	M12	20,000	1.7	1.9	●
	BT40-DSC20-90	20	90	33	42	52	M12	20,000	1.3	1.5	●
	BT40-DSC20-120	20	120	33	42	52	M12	20,000	1.5	1.8	●
	BT40-DSC20-160	20	160	33	42	52	M12	20,000	2.0	2.3	

(Unit : mm)

Chuck
Arbor/Modular
Boring tool
Angular head
CBN/PCD
TAUMAX
Other



BT-DSC/M MONO TYPE

Shrinking chuck MONO TYPE



Fig.1

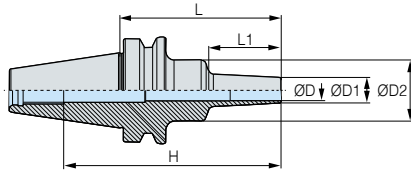
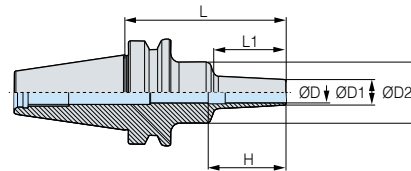

Fig.2



- : To be discontinued
- : Stock
- H : Depth of tool insertion

C Internal coolant system is basic

- For more information on product features, see **49p**
- For more information on the related parts, see **64p**

	Designation	ØD	L	ØD1	ØD2	L1	H	RPM	Fig.	Kg	Package weight(Kg)	Stock
BT40	BT40-DSC3M-95	3	95	8	26	42	128	20,000	1	1.1	1.2	●
	BT40-DSC4M-95	4	95	8	26	42	128	20,000	1	1.1	1.2	●
	BT40-DSC6M-95	6	95	10	26	42	128	20,000	1	1.0	1.2	●
	BT40-DSC6M-120	6	120	10	26	67	153	20,000	1	1.0	1.2	●
	BT40-DSC6M-160	6	160	10	36	97	193	20,000	1	1.2	1.3	●
	BT40-DSC8M-95	8	95	13	36	42	128	20,000	1	1.3	1.4	●
	BT40-DSC8M-120	8	120	13	36	67	153	20,000	1	1.3	1.5	●
	BT40-DSC8M-160	8	160	13	36	97	193	20,000	1	1.3	1.5	●
	BT40-DSC10M-95	10	95	16	36	42	128	20,000	1	1.1	1.3	●
	BT40-DSC10M-120	10	120	16	36	67	153	20,000	1	1.1	1.4	●
	BT40-DSC10M-160	10	160	16	36	97	193	20,000	1	1.3	1.6	●
	BT40-DSC12M-95	12	95	19	36	42	128	20,000	1	1.1	1.2	●
	BT40-DSC12M-120	12	120	19	36	67	153	20,000	1	1.2	1.4	●
	BT40-DSC12M-160	12	160	19	36	97	193	20,000	1	1.4	1.6	●
	BT40-DSC16M-95	16	95	24	50	42	47	20,000	2	1.3	1.5	●
	BT40-DSC16M-120	16	120	24	50	67	47	20,000	2	1.4	1.6	●
BT40-DSC16M-160	16	160	24	50	97	47	20,000	2	1.7	2.0		
BT40-DSC20M-95	20	95	29	50	42	55	20,000	2	1.3	1.5	●	
BT40-DSC20M-120	20	120	29	50	67	55	20,000	2	1.5	1.7		
BT40-DSC20M-160	20	160	29	50	97	55	20,000	2	1.9	2.1		
BT50	BT50-DSC6M-110	6	110	10	26	42	163	15,000	1	3.5	3.8	●
	BT50-DSC6M-160	6	160	10	36	97	213	15,000	1	3.6	4.0	●
	BT50-DSC8M-110	8	110	13	36	42	163	15,000	1	3.7	4.0	●
	BT50-DSC8M-160	8	160	13	36	97	213	15,000	1	3.7	4.1	●
	BT50-DSC10M-110	10	110	16	36	42	163	15,000	1	3.7	4.0	●
	BT50-DSC10M-160	10	160	16	36	97	213	15,000	1	3.7	4.1	●
	BT50-DSC12M-110	12	110	19	36	42	163	15,000	1	3.7	4.0	●
	BT50-DSC12M-160	12	160	19	50	97	213	15,000	1	4.0	4.4	●
	BT50-DSC16M-110	16	110	24	50	42	163	15,000	1	3.9	4.2	
	BT50-DSC16M-160	16	160	24	50	97	213	15,000	1	4.1	4.5	●
	BT50-DSC20M-110	20	110	29	50	42	55	15,000	2	3.9	4.2	●
	BT50-DSC20M-160	20	160	29	50	97	55	15,000	2	4.2	4.6	●

(Unit : mm)

Chuck

Arbor/Modular

Boring tool

Angular head

cBN/PCD

TAUMAX

Other

1:1 CHAT



BT-DSC/S MONO SLIM TYPE

Shrinking chuck MONO SLIM TYPE



MAS 403-BT
G2.5
25,000
3 μ m
C
Milling
Drilling
Reaming
Chamfering

Shank G value Max RPM Run-out Coolant System Milling Drilling Reaming Chamfering

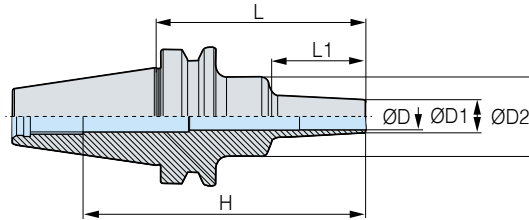

- : To be discontinued
- : Stock

C Internal coolant system is basic

※ Adjustment screws cannot be used for this product

• For more information on product features, see **49p**

• For more information on the related parts, see **64p**

	Designation	ØD	L	ØD1	ØD2	L1	H	RPM	Kg	Package weight(Kg)	Stock
BT30	BT30-DSC6S-60	6	60	9	20	22	82	25,000	0.4	0.5	●
	BT30-DSC6S-80	6	80	9	20	42	102	25,000	0.5	0.5	●
	BT30-DSC6S-120	6	120	9	25	67	142	25,000	0.5	0.6	●
BT40	BT40-DSC6S-95	6	95	9	26	42	128	20,000	1.0	1.2	●
	BT40-DSC6S-120	6	120	9	26	67	153	20,000	1.0	1.2	●
	BT40-DSC6S-160	6	160	9	36	97	193	20,000	1.2	1.4	●
	BT40-DSC8S-95	8	95	11	36	42	128	20,000	1.1	1.3	●
	BT40-DSC8S-120	8	120	11	36	67	153	20,000	1.1	1.3	●
	BT40-DSC8S-160	8	160	11	36	97	193	20,000	1.2	1.5	●
	BT40-DSC10S-95	10	95	13	36	42	128	20,000	1.0	1.2	●
	BT40-DSC10S-120	10	120	13	36	67	153	20,000	1.1	1.3	●
	BT40-DSC10S-160	10	160	13	36	97	193	20,000	1.2	1.5	●
	BT40-DSC12S-95	12	95	15	36	42	128	20,000	1.1	1.3	●
	BT40-DSC12S-120	12	120	15	36	67	153	20,000	1.1	1.3	●
	BT40-DSC12S-160	12	160	15	36	97	193	20,000	1.2	1.4	●
BT50	BT50-DSC6S-110	6	110	9	26	42	166	15,000	3.5	3.8	
	BT50-DSC6S-160	6	160	9	36	97	216	15,000	3.6	4.0	●
	BT50-DSC8S-110	8	110	11	36	42	166	15,000	3.6	3.9	
	BT50-DSC8S-160	8	160	11	36	97	216	15,000	3.6	4.0	●
	BT50-DSC10S-110	10	110	13	36	42	166	15,000	3.6	3.9	●
	BT50-DSC10S-160	10	160	13	36	97	216	15,000	3.6	4.0	●
	BT50-DSC12S-110	12	110	15	36	42	166	15,000	3.6	3.9	
	BT50-DSC12S-160	12	160	15	36	97	216	15,000	3.7	4.1	●

(Unit : mm)



CS/CM 2PIECES TYPE

Shrinking chuck 2PIECES TYPE

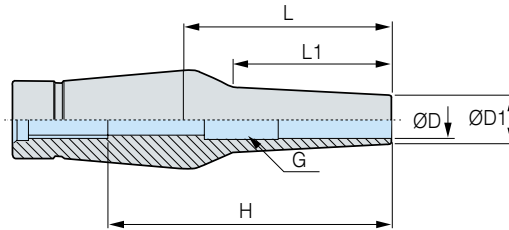

• H : Depth of tool insertion

C Internal coolant system is basic

※ Adjustment screws cannot be used for this product

• For more information on product features, see **49p**

• For more information on the related parts, see **64p**

	Designation	ØD	L	ØD1	L1	H	Kg	Package weight(Kg)	Stock
CS12	CS12-6-35	6	35	9	22	55	0.1	0.2	
	CS12-6-80	6	80	9	67	100	0.2	0.2	
	CS12-6-110	6	110	9	97	130	0.2	0.3	
	CS12-8-35	8	35	11	22	55	0.1	0.2	
	CS12-8-110	8	110	11	97	130	0.3	0.3	
	CS12-10-35	10	35	13	22	45	0.1	0.2	
	CS12-10-80	10	80	13	67	65	0.2	0.3	
	CS12-10-110	10	110	13	97	65	0.3	0.4	
	CS12-12-35	12	35	15	22	45	0.1	0.2	
	CS12-12-55	12	55	15	42	46	0.2	0.2	
	CS12-12-80	12	80	15	67	65	0.2	0.3	
	CS12-12-110	12	110	15	97	65	0.3	0.4	

(Unit : mm)

	Designation	ØD	L	ØD1	L1	H	G	Kg	Package weight(Kg)	Stock
CM12	CM12-6-35	6	35	12	22	55	M5	0.2	0.2	
	CM12-6-80	6	80	12	67	100	M5	0.2	0.3	
	CM12-8-35	8	35	14	22	55	M5	0.2	0.2	
	CM12-8-55	8	55	14	42	75	M5	0.2	0.2	
	CM12-8-80	8	80	14	67	100	M5	0.3	0.3	
	CM12-10-35	10	35	16	22	45	M8	0.2	0.2	
	CM12-10-55	10	55	16	42	45	M8	0.2	0.3	
	CM12-10-80	10	80	16	67	45	M8	0.3	0.3	
	CM12-12-35	12	35	20	22	45	M8	0.2	0.2	
	CM12-12-55	12	55	20	42	45	M8	0.3	0.3	
	CM12-12-80	12	80	20	52	55	M8	0.3	0.4	

(Unit : mm)

Chuck

Arbor/Modular

Boring tool

Angular head

CBN/PCD

TAUMAX

Other

1:1 CHAT



BT-SLK 2PIECES TYPE

Shrinking chuck 2PIECES TYPE

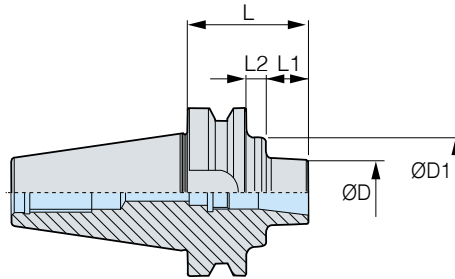

- For more information on CS/CM, see **63p**.
- For more information on product features, see **49p**.
- For more information on the related parts, see **64p**.

C Internal coolant system is basic

	Designation	ØD	L	ØD1	L1	L2	Kg	Package weight(Kg)	Stock
BT40	BT40-SLK12-45F	41	45	-	18	-	1.0	1.2	
	BT40-SLK12-75F	41	75	-	48	-	1.3	1.5	
	BT40-SLK12-135F	41	135	-	108	-	2.1	2.4	
BT50	BT50-SLK12-75	38	75	65	25	12	4.1	4.4	
	BT50-SLK12-75F	41	75	65	25	12	4.1	4.4	
	BT50-SLK12-105F	41	105	65	55	12	4.5	4.8	
	BT50-SLK12-135F	41	135	65	85	12	5.3	5.7	
	BT50-SLK12-225	38	225	65	150	37	6.2	6.6	
	BT50-SLK12-315	38	315	90	150	127	11.5	11.9	

(Unit : mm)

1:1 CHAT



DSC SPARE PART

Shrinking chuck related parts

SPARE PART	Type	Main component	Type	Accessories
		Adjust screw		Coolant tube for HSK
	Images		Images	
	Model No.		Model No.	
	DSC6, DSC8	M520C		
	DSC10, DSC12	M830C	HSK63A	HSK63A-CNS
	DSC14, DSC16, DSC18, DSC20, DSC25, DSC32	M1230C		

※ Slim & Mono type untightening



NPM

New power milling chuck

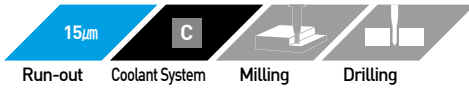

Features

- Strong clamping force more than 500kgf·m (based on NPM42)
- Uses its DUST BLOCK function to prevent outside foreign substance completely
- Enables jet coolant operation
- Implements high precision within 15µm in the case of L/D=3
- Clamping range : $\varnothing 20 \sim \varnothing 42$

NAMING

BT40	—	NPM	—	32	—	110
Spindle		New Power Milling Chuck		Tool dia.		Length



Strong clamping force

- NPM20 : Min. 130kgf·m
- NPM25 : Min. 265kgf·m
- NPM32 : Min. 350kgf·m
- NPM42 : Min. 500kgf·m
- NPM32(Short type) : Min. 230kgf·m

Durability enhanced by preventing foreign objects to be mixed (Dust Block) PAT.

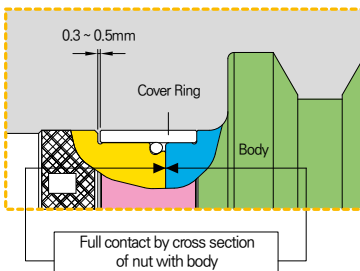

STOP RING applied to the front part
Preventing mixing of SHIM RING and O-Ring

NPM Structural Features



- Cover Ring
- O-Ring Shim Ring
- Stop Ring
- Needle Roller Bearing

• Needle Roller Bearing (NPM20)

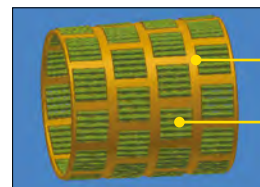

- Retainer
- Needle Roller Bearing

- Special steel bearing used to prevent damage
- Strong tightening due to load dispersion in the process of chucking

Enables stable machining from rough to medium boring

Ensures excellent vibration absorption and enhanced cutting power when cutting due to perfect cross-sectional adhesion and strong clamping force

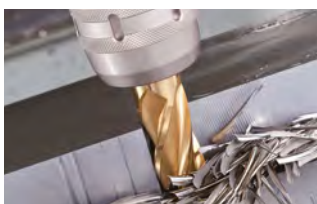

Enables stable operation from rough to medium machining



Radial cutting depth (Rd)=1.0mm



Radial cutting depth (Rd)=2.5mm



Radial cutting depth (Rd)=3.5mm



Radial cutting depth (Rd)=5.0mm



Radial cutting depth (Rd)=8.0mm



NPM

New power milling chuck

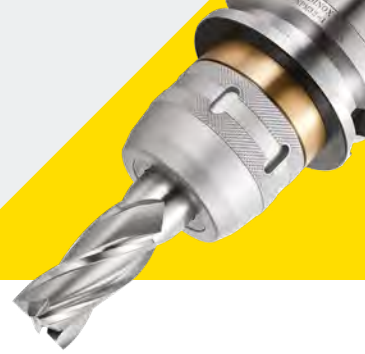

Type

- DBT Type : DBT30, DBT40, DBT50
- BT Type : BT30, BT40, BT50
- HSK Type : HSK63A, HSK50A, HSK100A
- SK Type : SK30, SK40, SK50
- NT Type : NT40, NT50



DBT Type BT Type HSK Type SK Type NT Type

High precision

- Run out accuracy within $15\mu\text{m}$ in the case of $L/D=3$
- Clamp inner diameter (Clamp I.D.) accuracy within $5\mu\text{m}$

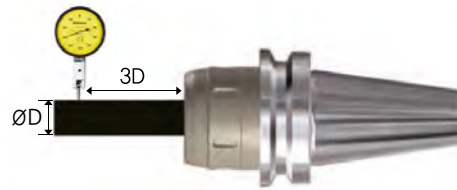

Runout within $15\mu\text{m}$ (measurement location : 3D)

Internal coolant applicable



NPM

+



CTC(Optional)

=



Internal coolant application system

Internal refueling system

- HSK shank is not available
- Add specifications of the CRS if not the basic application is adopted
EX) CTC20-6 : Nut + Screw + CSR-6 (Change to the Coolant Stop Ring specifications wanting to use instead of a basic model)

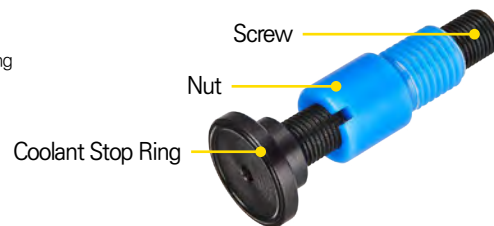

Designation	Nut	Screw	Coolant Stop Ring	Inner diameter(Ø)	Applicable shank	Remarks
CTC32(M16)-□□	CBN-M16N	CAS-M12	CSR-00	20, 25, 32	#30, 40, 50	#50 is not applicable to Inner diameter Ø32
CTC32(M24)-□□	CBN-M24N			32, 42	#50	

※ The above is an example.

※ For more information on product features, see **75p**.

CAUTION

- Be sure not to use a spanner with a pipe, etc. inserted when tightening a milling chuck.
- Excessive clamping can deform and/or adversely affect a cutting tool.
- When tightening a cutting tool, be sure not to touch it with bare hands.
- When using a collet, push it all the way into the milling chuck.
- If the insertion depth of the collet is not normal, the tool such as an end mill, etc. may fall out and/or the milling chuck may be internally damaged.
- In case of NPM milling chuck failure, do not disassemble it arbitrarily
- In case of a problem arising out of arbitrary disassembly, remember that no adjustment will be provided.

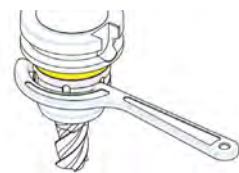

Removable within an average of 2.5 turns



DCJ

Jetcoolant collet (for milling chuck)



Features

- Ensures a longer service life of cutting tools by preventing chips from adhering to tools
- Improves chip breakability/breaking strong jet injection
- Maintains the performance of the conventional milling chuck
- Enables a fast change of the inside jet coolant by collet replacement
- Available an ultrahigh-pressure inside coolant



Designation	Ø6	Ø8	Ø10	Ø12	Ø16	Ø20	Ø25	Ø32
NPM20	✓	✓	✓	✓	✓			
NPM32	✓	✓	✓	✓	✓	✓	✓	
NPM42	✓	✓	✓	✓	✓	✓	✓	✓

※ Can be used for an ultrahigh-pressure inside coolant

NPM+JET Coolant Collet

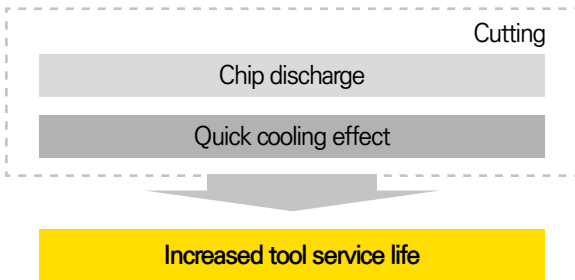

Easy Assembly

Can be used by only combining a collet with the conventional chuck (NPM)



Coolant Type

Jet Coolant



Inside Coolant



Chip evacuation



● : Stock

	Type	Designation	Stock
DCJ20	NPM20	DCJ20-6	
	NPM20	DCJ20-8	
	NPM20	DCJ20-10	
	NPM20	DCJ20-12	
	NPM20	DCJ20-16	
DCJ32	NPM32	DCJ32-6	
	NPM32	DCJ32-8	
	NPM32	DCJ32-10	
	NPM32	DCJ32-12	
	NPM32	DCJ32-16	
	NPM32	DCJ32-20	
	NPM32	DCJ32-25	

(Unit : mm)

Chuck

Arbor/Modular

Boring tool

Angular head

CBN/PCD

TAUMAX

Other

1:1 CHAT



DBT-NPM

New power milling chuck

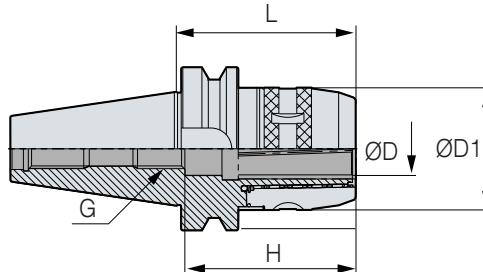
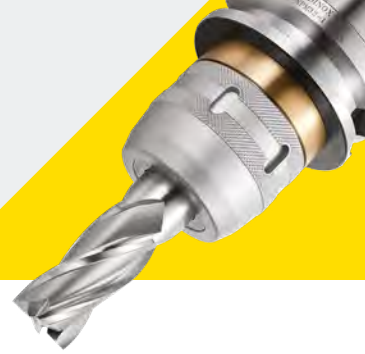

● : Stock

• H : Depth of tool insertion

C Internal coolant system is optional

• For more information on product features, see **65p**

• For more information on the related parts, see **75p**

	Designation	ØD	L	ØD1	H	G	COLLET	Kg	Package weight(Kg)	Stock
DBT30	DBT30-NPM20-85	20	85	54	85	M16	DC20, DCS20, DCJ20	1.1	1.3	
DBT40	DBT40-NPM20-85	20	85	54	85	M16	DC20, DCS20, DCJ20	2.3	2.5	●
	DBT40-NPM20-100	20	100	54	85	M16	DC20, DCS20, DCJ20	2.4	2.6	
	DBT40-NPM20-135	20	135	54	85	M16	DC20, DCS20, DCJ20	2.5	2.7	
	DBT40-NPM25-85	25	85	61	83	M16	DC25, DCS25	1.8	1.9	
	DBT40-NPM32-90	32	90	75	85	M16	DC32, DCS32, DCJ32	2.4	2.5	
	DBT40-NPM32-110	32	110	75	95	M16	DC32, DCS32, DCJ32	2.9	3.1	●
	DBT40-NPM32-120	32	120	75	95	M16	DC32, DCS32, DCJ32	3.1	3.3	
	DBT40-NPM32-135	32	135	75	95	M16	DC32, DCS32, DCJ32	3.4	3.6	
DBT50	DBT50-NPM20-95	20	95	54	85	M16	DC20, DCS20, DCJ20	4.3	4.6	
	DBT50-NPM20-105	20	105	54	85	M16	DC20, DCS20, DCJ20	4.5	4.8	●
	DBT50-NPM20-125	20	125	54	85	M16	DC20, DCS20, DCJ20	4.8	5.1	
	DBT50-NPM20-165	20	165	54	85	M16	DC20, DCS20, DCJ20	5.3	5.6	
	DBT50-NPM25-95	25	95	61	83	M16	DCS25, DC25	4.6	4.8	
	DBT50-NPM32-90	32	90	75	93	M24	DC32, DCS32, DCJ32	4.9	5.1	
	DBT50-NPM32-110	32	110	75	105	M24	DC32, DCS32, DCJ32	5.0	5.3	●
	DBT50-NPM32-135	32	135	75	105	M24	DC32, DCS32, DCJ32	5.8	6.2	
	DBT50-NPM32-165	32	165	75	105	M24	DC32, DCS32, DCJ32	6.9	7.3	
	DBT50-NPM42-110	42	110	90	125	M24	DC42, DCS42	5.6	5.9	●
	DBT50-NPM42-135	42	135	90	125	M24	DC42, DCS42	6.6	6.9	
	DBT50-NPM42-165	42	165	90	125	M24	DC42, DCS42	8.0	8.3	

※ Products with $L \leq 90$, are not recommended for roughing due to the application of short type nuts.

(Unit : mm)



BT-NPM

New power milling chuck



MAS 403-BT
15 μ m
130-500 kgf·m
C
Milling
Drilling

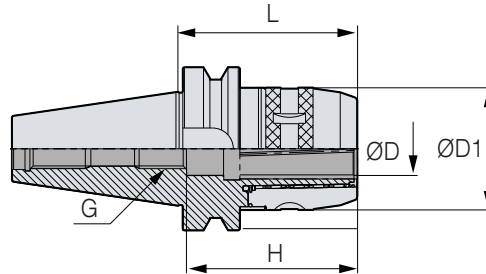

- : Stock
- H : Depth of tool insertion

C Internal coolant system is optional

- For more information on product features, see **65p**
- For more information on the related parts, see **75p**

	Designation	ØD	L	ØD1	H	G	COLLET	Kg	Package weight(Kg)	Stock
BT30	BT30-NPM20-85	20	85	54	85	M16	DC20, DCS20, DCJ20	1.2	1.3	●
BT40	BT40-NPM20-85	20	85	54	85	M16	DC20, DCS20, DCJ20	2.3	2.6	●
	BT40-NPM20-100	20	100	54	85	M16	DC20, DCS20, DCJ20	2.3	2.5	●
	BT40-NPM20-135	20	135	54	85	M16	DC20, DCS20, DCJ20	2.4	2.6	
	BT40-NPM25-85	25	85	61	83	M16	DC25, DCS25	1.7	1.9	●
	BT40-NPM32-90	32	90	75	85	M16	DC32, DCS32, DCJ32	2.3	2.5	●
	BT40-NPM32-110	32	110	75	95	M16	DC32, DCS32, DCJ32	2.8	3.1	●
	BT40-NPM32-120	32	120	75	95	M16	DC32, DCS32, DCJ32	3	3.3	
	BT40-NPM32-135	32	135	75	95	M16	DC32, DCS32, DCJ32	3.5	3.8	●
BT50	BT50-NPM20-95	20	95	54	85	M16	DC20, DCS20, DCJ20	4.3	4.6	●
	BT50-NPM20-125	20	125	54	85	M16	DC20, DCS20, DCJ20	4.7	5.1	●
	BT50-NPM20-165	20	165	54	85	M16	DC20, DCS20, DCJ20	5.2	5.6	●
	BT50-NPM25-95	25	95	61	83	M16	DC25, DCS25	4.6	4.8	
	BT50-NPM32-90	32	90	75	93	M24	DC32, DCS32, DCJ32	4.9	5.1	
	BT50-NPM32-110	32	110	75	105	M24	DC32, DCS32, DCJ32	5.0	5.3	●
	BT50-NPM32-135	32	135	75	105	M24	DC32, DCS32, DCJ32	5.7	6.1	●
	BT50-NPM32-165	32	165	75	105	M24	DC32, DCS32, DCJ32	6.9	7.3	●
	BT50-NPM42-110	42	110	90	125	M24	DC42, DCS42	5.4	5.7	●
	BT50-NPM42-135	42	135	90	125	M24	DC42, DCS42	6.5	6.9	●
	BT50-NPM42-165	42	165	90	125	M24	DC42, DCS42	7.9	8.3	●

※ Products with L≤90, are not recommended for roughing due to the application of short type nuts. (Unit : mm)

Chuck
 Arbor/Modular
 Boring tool
 Angular head
 CBN/PCD
 TAUMAX
 Other

1:1 CHAT



HSK-NPM

New power milling chuck

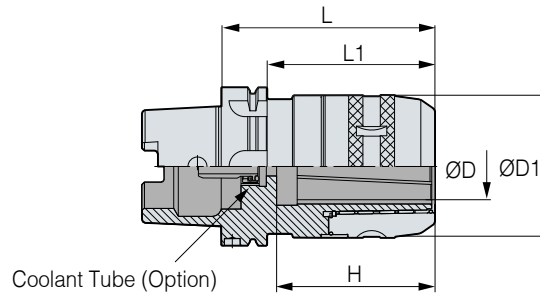
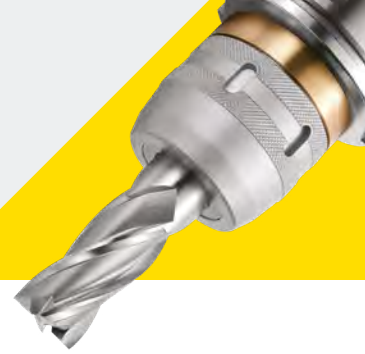

● : Stock

• H : Depth of tool insertion

C Internal coolant system is optional

• For more information on product features, see **65p**.

• For more information on the related parts, see **75p**.

	Designation	ØD	L	ØD1	L1	H	COLLET	Kg	Package weight(Kg)	Stock
HSK50A	HSK50A-NPM20-100	20	100	54	74	75	DC20, DCS20, DCJ20	1	1.2	
HSK63A	HSK63A-NPM20-100	20	100	54	74	75	DC20, DCS20, DCJ20	1.6	1.8	●
	HSK63A-NPM25-100	25	100	61	74	75	DC25, DCS25	1.9	2.1	
	HSK63A-NPM32-110	32	110	75	84	82	DC32, DCS32, DCJ32	2.5	2.7	
	HSK63A-NPM32-120	32	120	75	84	90	DC32, DCS32, DCJ32	2.9	2.8	●
HSK100A	HSK100A-NPM20-110	20	110	54	81	75	DC20, DCS20, DCJ20	3	3.2	
	HSK100A-NPM25-110	25	110	61	81	75	DC25, DCS25, DCJ25	3.2	3.4	
	HSK100A-NPM32-115	32	115	75	86	82	DC32, DCS32, DCJ32	4.1	4.4	
	HSK100A-NPM32-130	32	130	75	101	90	DC32, DCS32, DCJ32	4	4.9	●
	HSK100A-NPM42-135	42	135	90	106	100	DC42, DCS42	5.7	6.0	

(Unit : mm)

Accessories

SPARE PART	Type	Accessories	
			Coolant tube for HSK
	Images		
	Model No.		
	HSK50A		HSK50A-CNS
	HSK63A		HSK63A-CNS
	HSK100A		HSK100A-CNS



BT-NPM SET

New power milling chuck SET



MAS 403-BT
15 μ m
130-500 kgf·m
C
Milling
Drilling

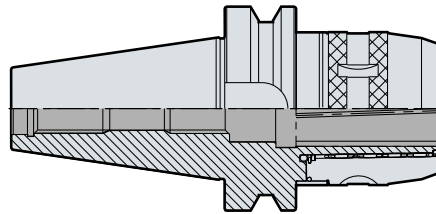

- : Stock
- HSK, SK / B Set are customizable
- C Internal coolant system is optional

• For more information on product features, see **65p**.

Type	BODY	COLLET	SPANNER	TC	DJT	Stock
Images						
Model No.						
A SET	BT40-NPM20-85(A)	BT40-NPM20-85	DC20-6, 8, 10, 12, 16	57-60	-	-
	BT40-NPM32-110(A)	BT40-NPM32-110	DC32-6, 8, 10, 12, 16, 20, 25	75-79	-	-
	BT50-NPM32-110(A)	BT50-NPM32-110	DC32-6, 8, 10, 12, 16, 20, 25	75-79	-	-
	BT50-NPM42-110(A)	BT50-NPM42-110	DC42-6, 8, 10, 12, 16, 20, 25	92-96	-	-
B SET	BT40-NPM20-85(B)	BT40-NPM20-85	DC20-6, 8, 10, 12, 16	57-60	TC20-1,2	DJT20-6
	BT40-NPM32-110(B)	BT40-NPM32-110	DC32-6, 8, 10, 12, 16, 20, 25	75-79	TC32-1,2,3	DJT32-6
	BT50-NPM32-110(B)	BT50-NPM32-110	DC32-6, 8, 10, 12, 16, 20, 25	75-79	TC32-1,2,3	DJT32-6
	BT50-NPM42-110(B)	BT50-NPM42-110	DC42-6, 8, 10, 12, 16, 20, 25	92-96	TC42-1,2,3	DJT42-6

(Unit : mm)

A Set



B Set



Chuck

Arbor/Modular

Boring tool

Angular head

CBN/PCD

TAUMAX

Other



NPM SPARE PART

New power milling chuck related parts



Chuck

Arbor/Modular

Boring tool

Angular head

CBN/PCD

TAUMAX

Other

Accessories for BT/SK

SPARE PART	Type	Accessories		
		Coolant system (BT/SK)	COLLET	SPANNER
	Images			
	Model No.			
	NPM20	CTC20-□□	DCS20, DC20, DCJ20	57-60
	NPM25	-	DCS32, DC32	61-65
	NPM32	CTC32-□□	DCS32, DC32, DCJ32	75-79
	NPM42	CTC42-□□	DC42, DCS42	92-96

Accessories for HSK

SPARE PART	Type	Accessories
		Coolant tube for HSK
	Images	
	Model No.	
	HSK50A	HSK50A-CNS
	HSK63A	HSK63A-CNS
	HSK100A	HSK100A-CNS

Internal refueling system

- HSK shank is not available
 - Select the CSR according to the outer diameter of the tool shank you want to use
- EX) CTC20-6 : Nut + Screw + CSR-6
- ※ Caution : If the coolant stop ring (CSR) is rotated continuously using Wrench that the coolant adjust screw(CAS) will be used, falls below the Coolant Bush Nut (CBN) and the CSR is dropped, so please be careful when using it.

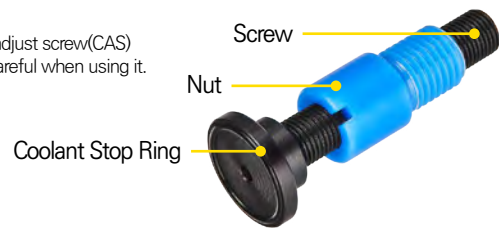
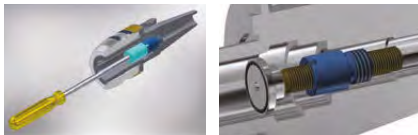

Designation	Nut	Screw	Coolant Stop Ring	Inner diameter(Ø)	홀구경	Applied screw(G)	Remarks
CTC20(M16)-□□	CBN-M16N	CAS-M12	CSR-□□	20	6,8,10,12,16,20	M16	-
CTC32(M16)-□□	CBN-M16N	CAS-M12	CSR-□□	32	6,8,10,12,16,20,25,32	M16	-
CTC32(M16)-□□	CBN-M24N	CAS-M12	CSR-□□	32	6,8,10,12,16,20,25,32	M24	-
CTC32(M16)-□□	CBN-M24N	CAS-M12	CSR-□□	42	6,8,10,12,16,20,25,32,42	M24	-
CTC42(M24)-□□	CBN-M24N	CAS-M12	CSR-□□	42	42	M24	-

※ For the CTC32 type, use two types, CTC32(M12) and CTC32(M24), because the standard of Adjust Screw per Shank is different.

※ For the Coolant Stop Ring (CSR), you can select the specification option that suits your situation.



DC

Straight collet

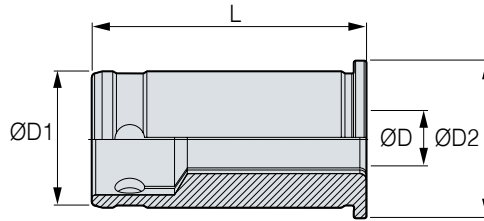

● : Stock

	Designation	ØD	L	ØD1	ØD2	Kg	Package weight(Kg)	Stock
DC20	DC20-6	6	53	20	25	0.1	0.1	●
	DC20-8	8	53	20	25	0.1	0.1	●
	DC20-10	10	53	20	25	0.1	0.1	●
	DC20-12	12	53	20	25	0.1	0.1	●
	DC20-14	14	53	20	25	0.1	0.1	●
	DC20-16	16	53	20	25	0.1	0.1	●
DC25	DC25-6	6	62	25	29	0.2	0.2	●
	DC25-8	8	62	25	29	0.2	0.2	●
	DC25-10	10	62	25	29	0.2	0.2	●
	DC25-12	12	62	25	29	0.2	0.2	●
	DC25-16	16	62	25	29	0.2	0.2	●
DC32	DC32-6	6	65	32	37	0.2	0.3	●
	DC32-8	8	65	32	37	0.2	0.3	●
	DC32-10	10	65	32	37	0.2	0.3	●
	DC32-12	12	65	32	37	0.2	0.3	●
	DC32-14	14	65	32	37	0.2	0.3	●
	DC32-16	16	65	32	37	0.2	0.3	●
	DC32-19	19	65	32	37	0.2	0.3	●
	DC32-20	20	65	32	37	0.2	0.3	●
	DC32-25	25	65	32	37	0.2	0.3	●
DC42	DC42-6	6	73	42	47	0.5	0.5	●
	DC42-8	8	73	42	47	0.5	0.5	●
	DC42-10	10	73	42	47	0.5	0.5	●
	DC42-12	12	73	42	47	0.5	0.5	●
	DC42-16	16	73	42	47	0.5	0.5	●
	DC42-20	20	73	42	47	0.5	0.5	●
	DC42-25	25	73	42	47	0.5	0.5	●
	DC42-32	32	73	42	47	0.5	0.5	●

(Unit : mm)

Chuck
Arbor/Modular
Boring tool
Angular head
CBN/PCD
TAUMAX
Other



DCL

Lock collet for milling chuck



Features

Milling chuck equipped with anti-fallout feature to prevent poor milling when machining a workpiece and improve tool service life (with DINE's milling chuck)

- Prevents the tool from falling out due to coolant pressure and vibration
- Useful for working with difficult-to-cut materials that require high workload
- Fit for difficult-to-cut materials with ultralight weight and high hardness in aerospace and automobile industries



NAMING

DCL	32	—	20
DINE lock-collet	Collet size		Tool dia.

Structural Features

Designed to prevent fallout

- Designed especially for extreme machining with a lot of mechanical actions, prevents the tool from deviating or pull out.
- Weldon flat (DINE 6535HB) end mill used

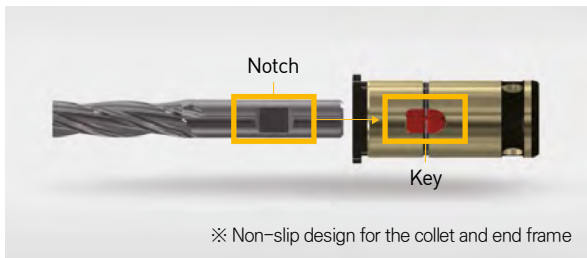

Designed as non-slip

- Closely adhered to the grooves of the milling chuck – No slip occurring even under high torque

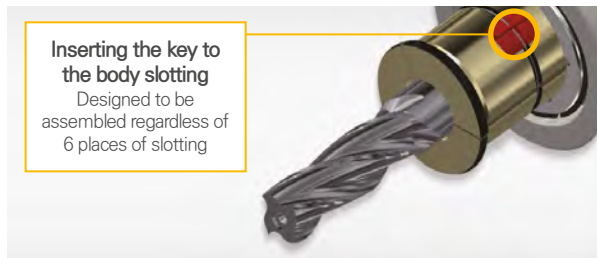

Detailed Specifications

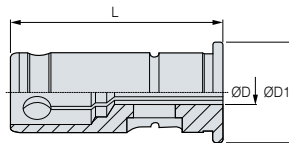

- ● : To be discontinued

※ Use DIN 6535HB standard end mill

	Designation	ØD	L	ØD1	Stock
DCL20	DCL20-6	6	53	20	●
	DCL20-8	8	53	20	●
	DCL20-10	10	53	20	●
	DCL20-12	12	53	20	●
	DCL20-14	14	53	20	●
	DCL20-16	16	53	20	●
DCL32	DCL32-6	6	65	32	●
	DCL32-8	8	65	32	●
	DCL32-10	10	65	32	●
	DCL32-12	12	65	32	●
	DCL32-14	14	65	32	●
	DCL32-16	16	65	32	●
	DCL32-18	18	65	32	●
	DCL32-20	20	65	32	●
	DCL32-25	25	65	32	●

※ Caution: In order to use DCL, an exclusive milling chuck is required, so please inquire the details at the sales department.

(Unit : mm)

Example order BT40-NPM32-110 (DCL)

Chuck

Arbor/Modular

Boring tool

Angular head

CBN/PCD

TAUMAX

Other



1:1 CHAT



DCL SPARE PART

Non-slip milling chuck collet related parts



SPARE PART	Type	Main component	
		KEY	C-GRIP
	Images		
	Model No.		
	DCL20-6	DCL20-6K	DCL-CG20
	DCL20-8	DCL20-8K	DCL-CG20
	DCL20-10	DCL20-10K	DCL-CG20
	DCL20-12	DCL20-12K	DCL-CG20
	DCL20-14	DCL20-14K	DCL-CG20
	DCL20-16	DCL20-16K	DCL-CG20
	DCL32-6	DCL32-6K	DCL-CG32
	DCL32-8	DCL32-8K	DCL-CG32
	DCL32-10	DCL32-10K	DCL-CG32
	DCL32-12	DCL32-12K	DCL-CG32
	DCL32-14	DCL32-14K	DCL-CG32
	DCL32-16	DCL32-16K	DCL-CG32
	DCL32-18	DCL32-18K	DCL-CG32
	DCL32-20	DCL32-20K	DCL-CG32
	DCL32-25	DCL32-25K	DCL-CG32

(Unit : mm)

1:1 CHAT



Notched Endmill (DIN 6535HB Shank)

Notched endmill

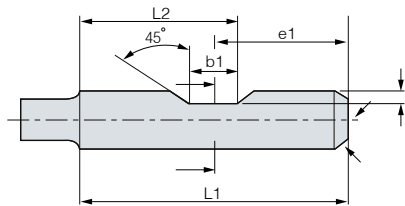

Tool Ø	Tool (DIN6535HB)				
	L1	e1	b1	L2	t
6	36	18	4.2	20.1	0.9
8	36	18	5.5	20.75	1.1
10	40	20	7	23.5	1.5
12	45	22.5	8	26.5	1.6
14	45	22.5	8	26.5	1.3
16	48	24	10	29	1.8
18	48	24	10	29	1.8
20	50	25	11	30.5	1.8
25	56	32	12	30	2.0
32	60	36	14	31	2.0

※ Use DIN 6535HB standard end mill

※ As a separate purchase, it can be referred to when using ERL/L collet.

(Unit : mm)

1:1 CHAT



SDC/PL NEW

Precision collet chuck (Length adjustment type)



Features

- Reduced tool setting time by designing the length to be adjustable from the outside
- fine length adjustment
- Equal height adjustment with easy setting

NAMING

BT40	—	SDC	16	P	L	—	130
Spindle		Collet chuck	Tool dia.	Precision	Length adjustment		Length



What is SDC/PL?

Reduced tool setting time by designing the length to be adjustable from the outside

Part name

Internal coolant system is basic

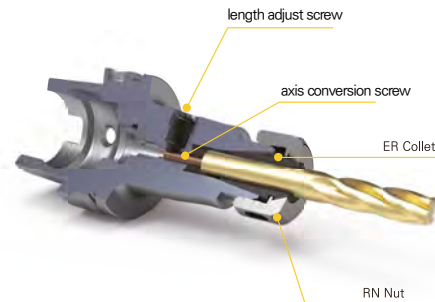

How to adjust length

Rotate the adjustment screw to adjust the tool length

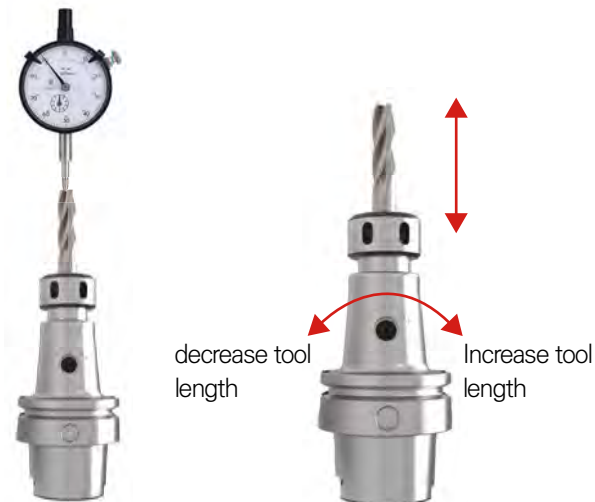

Test

WORK	MATERIAL	S45C
	HARDNESS	No
CUTTING CONDITION	V (m/min)	60
	F (mm/t)	0.05
	Ap (mm)	40
	Coolant	External coolant supply
	Machining distance (mm)	20

Ap (mm)	SDC/PL	General ER Collet Chuck
0.8mm		
	<ul style="list-style-type: none"> • Ra:1.058μm • Rz:6.354μm • Rt:8.307μm 	<ul style="list-style-type: none"> • Ra:1.110μm • Rz:6.078μm • Rt:8.895μm • Noise • Machining impossible



BT-SDC/PL NEW

Precision collet chuck (Length adjustment type)



Fig.1

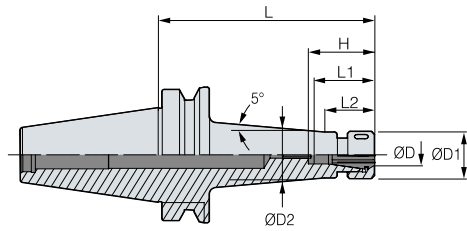
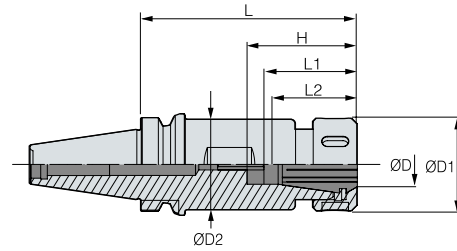

Fig.2



● : Stock

C Internal coolant system is optional

※ L1 : Length adjustable range

※ L2 : 5 ° Taper start point

• For more information on product features, see **82p**

• For more information on the related parts, see **85p**

• For more information on the applicable collet, see **95p**

	Designation	ØD	L	ØD1	ØD2	H	*L1	*L2	COLLET/STEP	Fig.	Stock
BT30	BT30-SDC13PL-100	1.0~13.0	100	35	34	49	39~49	37	GERC20/1.0	1	
	BT30-SDC16PL-100	1.0~16.0	100	42	41	50	40~50	45	GERC25/1.0	2	
	BT30-SDC20PL-120	1.0~20.0	120	50	49	60	50~60	55	GERC32/1.0	2	
BT40	BT40-SDC13PL-90	1.0~13.0	90	35	34	49	39~49	37	GERC20/1.0	1	
	BT40-SDC13PL-130	1.0~13.0	130	35	34	49	39~49	37	GERC20/1.0	1	
	BT40-SDC13PL-150	1.0~13.0	150	35	34	49	39~49	37	GERC20/1.0	1	
	BT40-SDC16PL-90	1.0~16.0	90	42	41	50	40~50	37	GERC25/1.0	1	
	BT40-SDC16PL-130	1.0~16.0	130	42	41	50	40~50	57	GERC25/1.0	1	
	BT40-SDC20PL-130	1.0~20.0	130	50	49	60	50~60	58	GERC32/1.0	1	
	BT40-SDC20PL-150	1.0~20.0	150	50	49	60	50~60	68	GERC32/1.0	1	
	BT40-SDC20PL-150	1.0~20.0	150	50	49	60	50~60	68	GERC32/1.0	1	
BT50	BT50-SDC13PL-100	1.0~13.0	100	35	34	49	39~49	37	GERC20/1.0	1	
	BT50-SDC13PL-130	1.0~13.0	130	35	34	49	39~49	37	GERC20/1.0	1	
	BT50-SDC13PL-160	1.0~13.0	160	35	34	49	39~49	37	GERC20/1.0	1	
	BT50-SDC13PL-180	1.0~13.0	180	35	34	49	39~49	37	GERC20/1.0	1	
	BT50-SDC16PL-100	1.0~16.0	100	42	41	50	40~50	37	GERC25/1.0	1	
	BT50-SDC16PL-160	1.0~16.0	160	42	41	50	40~50	67	GERC25/1.0	1	
	BT50-SDC20PL-130	1.0~20.0	130	50	49	60	50~60	52	GERC32/1.0	1	
	BT50-SDC20PL-160	1.0~20.0	160	50	49	60	50~60	67	GERC32/1.0	1	
	BT50-SDC20PL-180	1.0~20.0	180	50	49	60	50~60	77	GERC32/1.0	1	
	BT50-SDC26PL-160	1.0~26.0	160	63	62	71	61~71	68	GERC40/1.0	1	

(Unit : mm)

Chuck

Arbor/Modular

Boring tool

Angular head

cBN/PCD

TAUMAX

Other

1:1 CHAT



SDC/P

Precision collet chuck for multi purpose machining



Features

- Improved precision by applying a bearing nut
- Reorganization of toolholder length standard compared to SDC
- ER collet chuck is suitable for general-purpose processing with the highest grade sleeve nut
- Chucking Range : $\varnothing 1 \sim \varnothing 26$



NAMING

BT30 — **SDC** — **10** — **P** — **100**
 Spindle Collet chuck Tool dia. Precision Length

Bearing nuts designed for improved precision

Soft Sleeve Bearing RN Nut



Jet coolant disk applicable

After replacing with RT/RUT nut, connect RTJW to use jet coolant – internal coolant

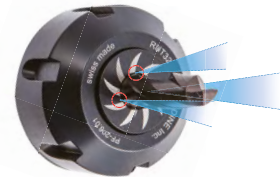

SDC/P Application

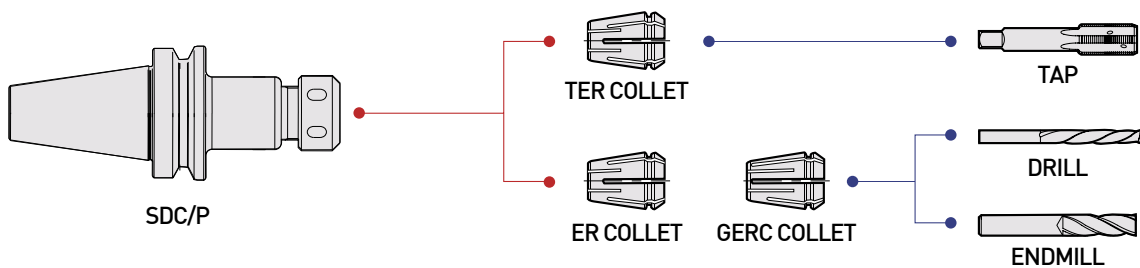

Spare Part

SPARE PART	Type	Main components		Type	Accessories	
		Sleeve bearing nut	Adjust screw		Spanner	Collet
	Images			Images		
	Model No.			Model No.		
	SDC7P	RN11	BN0716F	SDC7P	20-22	GERC/ER 11-ØD
	SDC10P	RN16	BN1025F	SDC10P	32-35	GERC/ER 16-ØD
	SDC13P	RN20	BN1325F	SDC13P	35-38	GERC/ER 20-ØD
	SDC16P	RN25	BN1830F	SDC16P	42-46	GERC/ER 25-ØD
	SDC20P	RN32	BN2230F	SDC20P	48-52	GERC/ER 32-ØD
	SDC26P	RN40	BN2838F	SDC26P	62-65	GERC/ER 40-ØD



DBT-SDC/P

Precision collet chuck for multi purpose machining



Fig.1

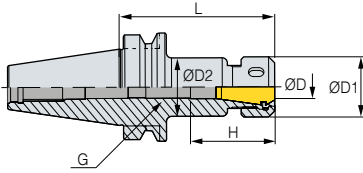

Fig.2

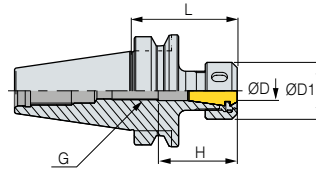
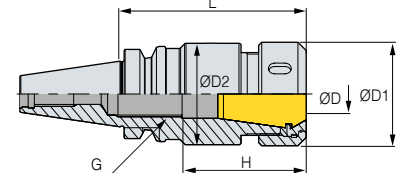

Fig.3



● : Stock

H : Depth of tool insertion

C Internal coolant system is optional

※ Using oil hole types requires the standard dimension

• For more information on product features, see **86p**

• For more information on the related parts, see **92p**

• For more information on the applicable collet, see **95p**

	Designation	ØD	L	ØD1	ØD2	H	COLLET	G	Fig.	Kg	Package weight(Kg)	Stock
DBT30	DBT30-SDC7P-70	1.0~7.0	70	18	17	33	GERC11	M7	1	0.5	0.5	
	DBT30-SDC7P-100	1.0~7.0	100	18	17	33	GERC11	M7	1	0.5	0.6	
	DBT30-SDC10P-50	1.0~10.0	50	32	-	45	GERC16	M10	2	0.5	0.6	
	DBT30-SDC10P-70	1.0~10.0	70	32	31	45	GERC16	M10	1	0.6	0.6	●
	DBT30-SDC10P-100	1.0~10.0	100	32	31	45	GERC16	M10	1	0.7	0.9	
	DBT30-SDC13P-50	1.0~13.0	50	35	-	49	GERC20	M13	2	0.5	0.6	
	DBT30-SDC13P-70	1.0~13.0	70	35	34	49	GERC20	M13	1	0.6	0.7	
	DBT30-SDC13P-100	1.0~13.0	100	35	34	49	GERC20	M13	1	0.8	0.9	
	DBT30-SDC16P-50	2.0~16.0	50	42	-	50	GERC25	M18	2	0.5	0.6	
	DBT30-SDC16P-70	2.0~16.0	70	42	41	50	GERC25	M18	1	0.7	0.8	
	DBT30-SDC16P-100	2.0~16.0	100	42	41	50	GERC25	M18	1	1	1.1	
	DBT30-SDC20P-60	2.0~20.0	60	50	-	60	GERC32	M22	2	0.6	0.7	●
DBT30-SDC20P-90	2.0~20.0	90	50	49	60	GERC32	M22	3	1.0	1.1	●	
DBT30-SDC20P-120	2.0~20.0	120	50	49	60	GERC32	M22	3	1.4	1.5		
DBT40	DBT40-SDC7P-70	1.0~7.0	70	18	17	33	GERC11	M7	1	0.9	1.1	
	DBT40-SDC7P-90	1.0~7.0	90	18	17	33	GERC11	M7	1	0.9	1.2	●
	DBT40-SDC7P-130	1.0~7.0	130	18	17	33	GERC11	M7	1	1	1.2	
	DBT40-SDC10P-70	1.0~10.0	70	32	31	45	GERC16	M10	1	1	1.2	
	DBT40-SDC10P-90	1.0~10.0	90	32	31	45	GERC16	M10	1	1.2	1.4	●
	DBT40-SDC10P-130	1.0~10.0	130	32	31	45	GERC16	M10	2	1.4	1.5	●
	DBT40-SDC13P-70	1.0~13.0	70	35	34	49	GERC20	M13	1	1.1	1.2	
	DBT40-SDC13P-90	1.0~13.0	90	35	34	49	GERC20	M13	1	1.2	1.4	●
	DBT40-SDC13P-130	1.0~13.0	130	35	34	49	GERC20	M13	1	1.4	1.6	
	DBT40-SDC13P-150	1.0~13.0	150	35	34	49	GERC20	M13	1	1.6	1.8	
	DBT40-SDC16P-70	2.0~16.0	70	42	41	50	GERC25	M18	1	1.1	1.3	
	DBT40-SDC16P-90	2.0~16.0	90	42	41	50	GERC25	M18	1	1.3	1.5	●
	DBT40-SDC16P-130	2.0~16.0	130	42	41	50	GERC25	M18	1	1.7	1.9	
	DBT40-SDC20P-70	2.0~20.0	70	50	-	60	GERC32	M22	2	1.1	1.3	
	DBT40-SDC20P-90	2.0~20.0	90	50	49	60	GERC32	M22	1	1.4	1.6	●
	DBT40-SDC20P-130	2.0~20.0	130	50	49	60	GERC32	M22	1	1.9	2.2	●
	DBT40-SDC20P-150	2.0~20.0	150	50	49	60	GERC32	M22	1	2.2	2.5	
	DBT40-SDC26P-90	16.0~25.0	90	63	62	71	GERC40	M28	1	1.7	1.9	

(Unit : mm)

Chuck

Arbor/Modular

Boring tool

Angular head

cBN/PCD

TAUMAX

Other



BT-SDC/P

Precision collet chuck for multi purpose machining



Fig.1

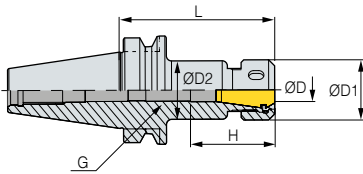

Fig.2

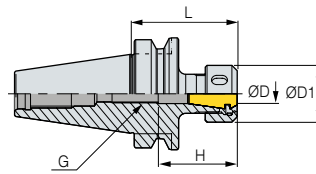
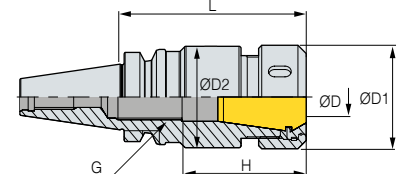

Fig.3



● : Stock

H : Depth of tool insertion

C Internal coolant system is optional

※ Using oil hole types requires the standard dimension

• For more information on product features, see **86p**

• For more information on the related parts, see **92p**

• For more information on the applicable collet, see **95p**

	Designation	ØD	L	ØD1	ØD2	H	COLLET	G	Fig.	Kg	Package weight(Kg)	Stock
BT30	BT30-SDC7P-70	1.0~7.0	70	18	17	33	GERC11	M7	1	0.5	0.5	●
	BT30-SDC7P-100	1.0~7.0	100	18	17	33	GERC11	M7	1	0.5	0.6	●
	BT30-SDC10P-50	1.0~10.0	50	32	-	45	GERC16	M10	2	0.5	0.6	●
	BT30-SDC10P-70	1.0~10.0	70	32	31	45	GERC16	M10	1	0.6	0.6	●
	BT30-SDC10P-100	1.0~10.0	100	32	31	45	GERC16	M10	1	0.7	0.9	●
	BT30-SDC13P-50	1.0~13.0	50	35	-	49	GERC20	M13	2	0.5	0.6	●
	BT30-SDC13P-70	1.0~13.0	70	35	34	49	GERC20	M13	1	0.6	0.7	●
	BT30-SDC13P-100	1.0~13.0	100	35	34	49	GERC20	M13	1	0.8	0.9	●
	BT30-SDC16P-50	2.0~16.0	50	42	-	50	GERC25	M18	2	0.5	0.6	●
	BT30-SDC16P-70	2.0~16.0	70	42	41	50	GERC25	M18	1	0.7	0.8	●
	BT30-SDC16P-100	2.0~16.0	100	42	41	50	GERC25	M18	1	1.0	1.1	●
BT30-SDC20P-60	2.0~20.0	60	50	-	60	GERC32	M22	2	0.6	0.7	●	
BT30-SDC20P-90	2.0~20.0	90	50	49	60	GERC32	M22	3	1.0	1.1	●	
BT30-SDC20P-120	2.0~20.0	120	50	49	60	GERC32	M22	3	1.4	1.5	●	
BT40	BT40-SDC7P-70	1.0~7.0	70	18	17	33	GERC11	M7	1	0.9	1.1	●
	BT40-SDC7P-90	1.0~7.0	90	18	17	33	GERC11	M7	1	0.9	1.2	●
	BT40-SDC7P-130	1.0~7.0	130	18	17	33	GERC11	M7	1	1.0	1.2	●
	BT40-SDC10P-70	1.0~10.0	70	32	31	45	GERC16	M10	1	1.0	1.2	●
	BT40-SDC10P-90	1.0~10.0	90	32	31	45	GERC16	M10	1	1.2	1.4	●
	BT40-SDC10P-130	1.0~10.0	130	32	31	45	GERC16	M10	2	1.4	1.5	●
	BT40-SDC13P-70	1.0~13.0	70	35	34	49	GERC20	M13	1	1.1	1.2	●
	BT40-SDC13P-90	1.0~13.0	90	35	34	49	GERC20	M13	1	1.2	1.4	●
	BT40-SDC13P-130	1.0~13.0	130	35	34	49	GERC20	M13	1	1.4	1.6	●
	BT40-SDC13P-150	1.0~13.0	150	35	34	49	GERC20	M13	1	1.6	1.8	●
	BT40-SDC16P-70	2.0~16.0	70	42	41	50	GERC25	M18	1	1.1	1.3	●
	BT40-SDC16P-90	2.0~16.0	90	42	41	50	GERC25	M18	1	1.3	1.5	●
	BT40-SDC16P-130	2.0~16.0	130	42	41	50	GERC25	M18	1	1.7	1.9	●
	BT40-SDC20P-70	2.0~20.0	70	50	-	60	GERC32	M22	2	1.1	1.3	●
	BT40-SDC20P-90	2.0~20.0	90	50	49	60	GERC32	M22	1	1.4	1.6	●
	BT40-SDC20P-130	2.0~20.0	130	50	49	60	GERC32	M22	1	1.9	2.2	●
	BT40-SDC20P-150	2.0~20.0	150	50	49	60	GERC32	M22	1	2.2	2.5	●
	BT40-SDC26P-90	16.0~25.0	90	63	62	71	GERC40	M28	1	1.7	1.9	●

(Unit : mm)

Chuck

Arbor/Modular

Boring tool

Angular head

CBN/PCD

TAUMAX

Other



HSK-SDC/P

Precision collet chuck for multi purpose machining

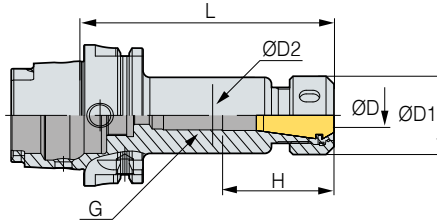

- : Stock
- H : Depth of tool insertion

C Internal coolant system is optional

※ Using oil hole types requires the standard dimension

- For more information on product features, see **86p**
- For more information on the related parts, see **92p**
- For more information on the applicable collet, see **95p**

	Designation	ØD	L	ØD1	ØD2	H	G	COLLET	Kg	Package weight(Kg)	Stock
HSK63A	HSK63A-SDC7P-100	1.0-7.0	100	18	17	33	M7	GERC11	0.9	1	
	HSK63A-SDC7P-120	1.0-7.0	120	18	17	34	M8	GERC11	0.9	1	
	HSK63A-SDC10P-100	1.0-10.0	100	32	31	44.5	M10	GERC16	1	1.1	●
	HSK63A-SDC10P-120	1.0-10.0	120	32	31	44.5	M10	GERC16	1	1.1	
	HSK63A-SDC13P-100	1.0-13.0	100	35	34	49	M7	GERC20	1.1	1.2	●
	HSK63A-SDC13P-120	1.0-13.0	120	35	34	49	M7	GERC20	1.2	1.4	
	HSK63A-SDC13P-150	1.0-13.0	150	35	34	49	M7	GERC20	1.2	1.4	
	HSK63A-SDC16P-100	2.0-16.0	100	42	41	50	M7	GERC25	1.2	1.4	●
	HSK63A-SDC20P-110	2.0-20.0	110	50	49	60	M7	GERC32	1.5	1.7	●
	HSK63A-SDC26P-130	16.0-25.0	130	63	62	71	M10	GERC40	1.6	1.8	
HSK100A	HSK100A-SDC7P-100	1.0-7.0	100	18	17	33	M7	GERC11	2.0	2.2	
	HSK100A-SDC10P-100	1.0-10.0	100	32	31	44.5	M10	GERC16	2.2	2.4	
	HSK100A-SDC13P-100	1.0-13.0	100	35	34	49	M7	GERC20	2.4	2.6	
	HSK100A-SDC16P-110	2.0-16.0	100	42	41	50	M13	GERC25	2.6	2.9	●
	HSK100A-SDC20P-120	2.0-20.0	120	50	49	60	M10	GERC32	2.9	3.3	●
	HSK100A-SDC26P-130	16.0-25.0	130	63	62	71	M28	GERC40	3.8	4	

(Unit : mm)

Accessories

SPARE PART	Type	Accessories
	Images	
	Model No.	
	HSK63A	HSK63A-CNS
	HSK100A	HSK100A-CNS

1:1 CHAT



SK-SDC/P

Precision collet chuck for multi purpose machining

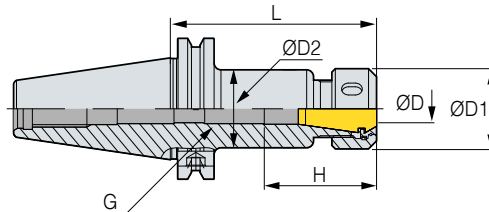

- ● : To be discontinued
- ● : Stock
- H : Depth of tool insertion

C Internal coolant system is optional

※ Using oil hole types requires the standard dimension

- For more information on product features, see **86p**
- For more information on the related parts, see **92p**
- For more information on the applicable collet, see **95p**

	Designation	ØD	L	ØD1	ØD2	H	COLLET	G	Kg	Package weight(Kg)	Stock
SK40	SK40-SDC10P-90	1.0~10.0	90	32	31	44.5	GERC16	M10	1.1	1.2	●
	SK40-SDC13P-90	1.0~13.0	90	35	34	49	GERC20	M13	1.2	1.3	●
	SK40-SDC13P-120	1.0~13.0	120	35	34	49	GERC20	M13	1.3	1.5	●
	SK40-SDC16P-90	2.0~16.0	90	42	41	50	GERC25	M18	1.4	1.5	●
	SK40-SDC20P-90	2.0~20.0	90	50	49	60	GERC32	M13	1.5	1.6	●

(Unit : mm)

1:1 CHAT



SDC/P SPARE PART

ER collet chuck related parts

SPARE PART	Type	Main components		Accessories	
		Sleeve bearing nut	Adjust screw	Spanner	Collet
	Images				
	Model No.				
	SDC7P	RN11	BN0716F	20-22	GERC/ER 11-ØD
	SDC10P	RN16	BN1025F	32-35	GERC/ER 16-ØD
	SDC13P	RN20	BN1325F	35-38	GERC/ER 20-ØD
	SDC16P	RN25	BN1830F	42-46	GERC/ER 25-ØD
	SDC20P	RN32	BN2230F	48-52	GERC/ER 32-ØD
	SDC26P	RN40	BN2838F	62-65	GERC/ER 40-ØD

※ BT30-SDC13P-50/ HSK63A-SDC13P-100 is applied with BN0716F screw.



S-SDC

Straight shank collet chuck

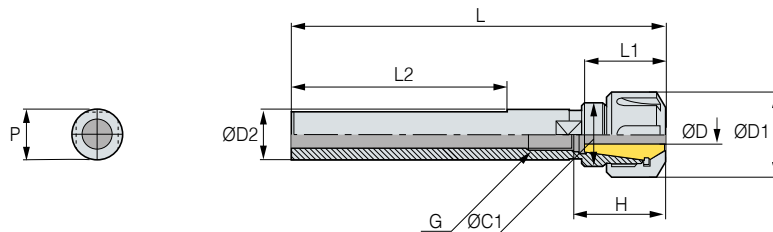

● : Stock

C Internal coolant system is optional

• For more information on the applicable collet, see **95p**

	Designation	ØD	L	ØD1	ØD2	P	ØC1	L1	L2	H	COLLET	G	Kg	Package weight(Kg)	Stock
S16	S16-SDC7-120M	1.0~7.0	120	19	16	-	16	-	-	33	GERC11	M7	0.1	0.2	●
	S16-SDC7-120T	1.0~7.0	120	19	16	15	16	-	73	33	GERC11	M7	0.1	0.2	●
	S16-SDC10-150T	1.0~10.0	150	28	16	15	22	46.5	83	34.5	GERC16	M10	0.2	0.3	●
S20	S20-SDC10-150M	1.0~10.0	150	28	20	-	22	26.5	-	34.5	GERC16	M10	0.3	0.4	●
	S20-SDC10-150T	1.0~10.0	150	28	20	19	22	26.5	83	34.5	GERC16	M10	0.3	0.4	●
	S20-SDC13-150M	1.0~13.0	150	35	20	-	25	50	-	49	GERC20	M13	0.3	0.4	●
	S20-SDC13-150T	1.0~13.0	150	35	20	19	25	50	83	49	GERC20	M13	0.3	0.4	●
S25	S25-SDC10-150M	1.0~10.0	150	28	25	-	22	-	-	34.5	GERC16	M10	0.4	0.5	●
	S25-SDC10-150T	1.0~10.0	150	28	25	24	22	-	83	34.5	GERC16	M10	0.4	0.5	●
	S25-SDC13-150M	1.0~13.0	150	35	25	-	25	-	-	49	GERC20	M13	0.4	0.5	●
	S25-SDC13-150T	1.0~13.0	150	35	25	24	25	-	83	49	GERC20	M13	0.4	0.5	●
S32	S32-SDC13-150M	1.0~13.0	150	35	32	-	25	-	-	49	GERC20	M13	0.7	0.8	●
	S32-SDC13-150T	1.0~13.0	150	35	32	31	25	-	83	49	GERC20	M13	0.7	0.8	●
	S32-SDC20-165M	2.0~20.0	165	50	32	-	40	-	-	60	GERC32	M22	0.9	1	●
	S32-SDC20-165T	2.0~20.0	165	50	32	31	40	-	83	60	GERC32	M22	0.9	1	●

※ For milling (M)/ for turning (T) – e.g.) S16-SDC7-120M (for milling) / S16-SDC7-120T (for turning)

(Unit : mm)

※ It can be used in combination with a milling chuck.

SPARE PART	Type	Main components		Accessories		
		Nut		Spanner		GERC/ER
	Images					
	Model No.					
	S-SDC7	R11		S-17		GERC11/ER11-ØD
	S-SDC10	R16		S-25		GERC16/ER16-ØD
	S-SDC13		RU20		35-38	GERC20/ER20-ØD
	S-SDC20		RU32		48-52	GERC32/ER32-ØD



S-SDC/S

Straight shank collet chuck slim type



Fig.1

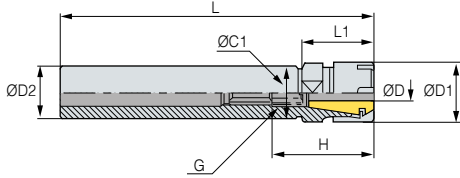
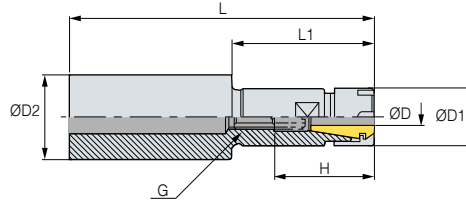

Fig.2



- : Stock
- H : Depth of tool insertion

C Internal coolant system is optional

• For more information on the applicable collet, see **95p**.

	Designation	ØD	L	ØD1	ØD2	L1	H	COLLET/STEP	G	Kg	Package weight(Kg)	Stock
S16	S16-SDC7S-100M	1.0~7.0	100	16	16	21	33	GERC11/0.5	M7	0.1	0.2	●
	S16-SDC7S-150M	1.0~7.0	150	16	16	21	33	GERC11/0.5	M7	0.1	0.2	●
	S16-SDC10S-100M	1.0~10.0	100	22	16	50	4.5	GERC16/1.0	M10	0.1	0.2	●
	S16-SDC10S-150M	1.0~10.0	150	22	16	50	4.5	GERC16/1.0	M10	0.1	0.2	●
S20	S20-SDC7S-100M	1.0~7.0	100	16	20	30	35	GERC11/0.5	M7	0.1	0.2	●
	S20-SDC7S-150M	1.0~7.0	150	16	20	80	35	GERC11/0.5	M7	0.2	0.3	●
	S20-SDC10S-100M	1.0~10.0	100	22	20	50	4.5	GERC16/1.0	M10	0.1	0.2	●
	S20-SDC10S-150M	1.0~10.0	150	22	20	50	4.5	GERC16/1.0	M10	0.2	0.3	●
	S20-SDC10S-200M	1.0~10.0	200	22	20	50	4.5	GERC16/1.0	M10	0.3	0.4	●
	S20-SDC13S-100M	1.0~13.0	100	28	20	50	49	GERC20/1.0	M13	0.1	0.2	●
S25	S25-SDC13S-150M	1.0~13.0	150	28	20	50	49	GERC20/1.0	M13	0.2	0.3	●
	S25-SDC7S-100M	1.0~7.0	100	16	25	30	33	GERC11/0.5	M7	0.2	0.3	●
	S25-SDC7S-150M	1.0~7.0	150	16	25	80	33	GERC11/0.5	M7	0.2	0.3	●
	S25-SDC10S-100M	1.0~10.0	100	22	25	30	4.5	GERC16/1.0	M10	0.2	0.3	●
	S25-SDC10S-150M	1.0~10.0	150	22	25	80	4.5	GERC16/1.0	M10	0.3	0.4	●
	S25-SDC13S-100M	1.0~13.0	100	28	25	50	49	GERC20/1.0	M13	0.2	0.3	●
	S25-SDC13S-150M	1.0~13.0	150	28	25	50	49	GERC20/1.0	M13	0.4	0.5	●
	S25-SDC16S-100M	1.0~16.0	100	35	25	50	50	GERC25/1.0	M18	0.3	0.4	●
S32	S25-SDC16S-150M	1.0~16.0	150	35	25	50	50	GERC25/1.0	M18	0.4	0.5	●
	S25-SDC16S-200M	1.0~16.0	200	35	25	50	50	GERC25/1.0	M18	0.6	0.7	●
	S32-SDC16S-120M	1.0~16.0	120	35	32	50	50	GERC25/1.0	M18	0.5	0.6	●
	S32-SDC16S-150M	1.0~16.0	150	35	32	50	50	GERC25/1.0	M18	0.6	0.7	●

(Unit : mm)

SPARE PART	Type	Main components		Accessories	
		Nut		Spanner	GERC/ER
	Images				
	Model No.				
	S-SDC7S	R11M		M11M	GERC11/ER11-ØD
	S-SDC10S	R16M		M16M	GERC16/ER16-ØD
	S-SDC13S	R20M		M20M	GERC20/ER20-ØD
	S-SDC16S	R25M		M25M	GERC25/ER25-ØD



GERC

GERC Collet



General 5 μ m	Precision 2 μ m	Waterproof	ER collet
Run-out	Run-out		

Features

- Collet that prevents surface corrosion to micro range
- Maintains functionality and precision for a long time based on advanced coating technology
- Economic use for tool life

NAMING

GERC	16	—	4	HP
GERC Collet	Collet size		Tool dia.	HP : Precision NON : General



Special coating technology

The characteristics of the conventional unprotected collet unlike GERC collets are as follows:

The conventional uncoated collet is affected by corrosion in a short time due to various causes such as humidity, cutting oil, detergent, salt, and gas. This affects not only the collet but also the entire machining process.

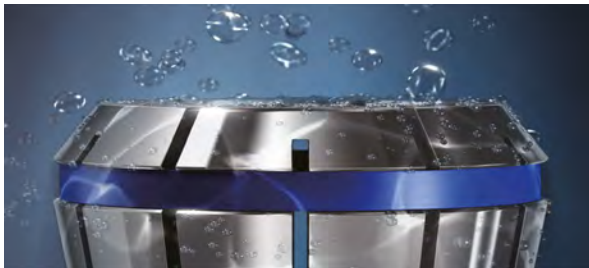

A rusty collet shortens tool service life and greatly lowers precision. To avoid this situation, surface coating is performed to micro range to effectively protect a collet and maintain its precision for a long time by preventing it from corroding in the long term.



Two collets used for 4 months :

The left one is an uncoated collet, and the right one is a GERC-used collet.

GERC-HP (Precision type)

The precision type collet chuck is more expensive than the general collect chuck but in terms of long-term cost efficiency, its benefits are far greater. Its maximum accuracy provides more excellent workpieces due to its less manufacturing tolerance, minimizing costly re-work.

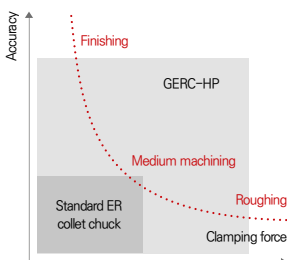

Precision type 2 μ m

Accuracy (L/D=3)

- General type = 5 μ m
- Precision type = 2 μ m

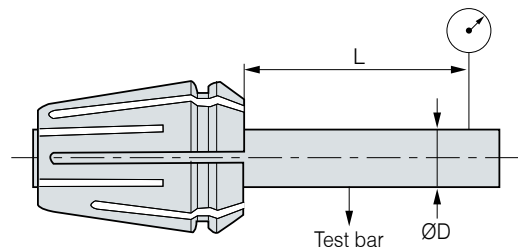

Chuck

Arbor/Modular

Boring tool

Angular head

CBN/PCD

TAUMAX

Other



GERC COLLET

GERC collet (general type)



General
5 μ m

ER

Run-out

ER collet

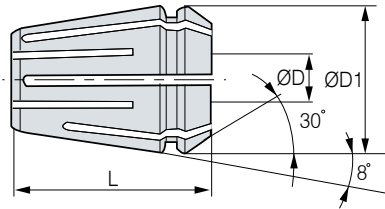

● : Stock

Designation	ER Size	ØD	L	ØD1	Accuracy	Stock
GERC11 GERC11-1.0	11	1.0	18.0	11.5	5 μ m	●
GERC11-1.5	11	1.5	18.0	11.5	5 μ m	●
GERC11-2.0	11	2.0	18.0	11.5	5 μ m	●
GERC11-2.5	11	2.5	18.0	11.5	5 μ m	●
GERC11-3.0	11	3.0	18.0	11.5	5 μ m	●
GERC11-3.5	11	3.5	18.0	11.5	5 μ m	●
GERC11-4.0	11	4.0	18.0	11.5	5 μ m	●
GERC11-4.5	11	4.5	18.0	11.5	5 μ m	●
GERC11-5.0	11	5.0	18.0	11.5	5 μ m	●
GERC11-5.5	11	5.5	18.0	11.5	5 μ m	●
GERC11-6.0	11	6.0	18.0	11.5	5 μ m	●
GERC11-6.5	11	6.5	18.0	11.5	5 μ m	●
GERC11-7.0	11	7.0	18.0	11.5	5 μ m	●
GERC16 GERC16-1.0	16	1.0	27.5	17.0	5 μ m	●
GERC16-2.0	16	2.0	27.5	17.0	5 μ m	●
GERC16-3.0	16	3.0	27.5	17.0	5 μ m	●
GERC16-4.0	16	4.0	27.5	17.0	5 μ m	●
GERC16-4.5	16	4.5	27.5	17.0	5 μ m	●
GERC16-5.0	16	5.0	27.5	17.0	5 μ m	●
GERC16-6.0	16	6.0	27.5	17.0	5 μ m	●
GERC16-7.0	16	7.0	27.5	17.0	5 μ m	●
GERC16-8.0	16	8.0	27.5	17.0	5 μ m	●
GERC16-9.0	16	9.0	27.5	17.0	5 μ m	●
GERC16-10.0	16	10.0	27.5	17.0	5 μ m	●
GERC20 GERC20-1.0	20	1.0	31.5	21.0	5 μ m	●
GERC20-2.0	20	2.0	31.5	21.0	5 μ m	●
GERC20-3.0	20	3.0	31.5	21.0	5 μ m	●
GERC20-4.0	20	4.0	31.5	21.0	5 μ m	●
GERC20-5.0	20	5.0	31.5	21.0	5 μ m	●
GERC20-6.0	20	6.0	31.5	21.0	5 μ m	●
GERC20-7.0	20	7.0	31.5	21.0	5 μ m	●
GERC20-8.0	20	8.0	31.5	21.0	5 μ m	●
GERC20-9.0	20	9.0	31.5	21.0	5 μ m	●
GERC20-10.0	20	10.0	31.5	21.0	5 μ m	●
GERC20-11.0	20	11.0	31.5	21.0	5 μ m	●
GERC20-12.0	20	12.0	31.5	21.0	5 μ m	●
GERC20-13.0	20	13.0	31.5	21.0	5 μ m	●

Designation	ER Size	ØD	L	ØD1	Accuracy	Stock
GERC25 GERC25-2.0	25	2.0	34.0	26.0	5 μ m	●
GERC25-3.0	25	3.0	34.0	26.0	5 μ m	●
GERC25-4.0	25	4.0	34.0	26.0	5 μ m	●
GERC25-5.0	25	5.0	34.0	26.0	5 μ m	●
GERC25-6.0	25	6.0	34.0	26.0	5 μ m	●
GERC25-7.0	25	7.0	34.0	26.0	5 μ m	●
GERC25-8.0	25	8.0	34.0	26.0	5 μ m	●
GERC25-9.0	25	9.0	34.0	26.0	5 μ m	●
GERC25-10.0	25	10.0	34.0	26.0	5 μ m	●
GERC25-11.0	25	11.0	34.0	26.0	5 μ m	●
GERC25-12.0	25	12.0	34.0	26.0	5 μ m	●
GERC25-13.0	25	13.0	34.0	26.0	5 μ m	●
GERC25-14.0	25	14.0	34.0	26.0	5 μ m	●
GERC25-15.0	25	15.0	34.0	26.0	5 μ m	●
GERC25-16.0	25	16.0	34.0	26.0	5 μ m	●
GERC32 GERC32-2.0	32	2.0	40.0	33.0	5 μ m	●
GERC32-3.0	32	3.0	40.0	33.0	5 μ m	●
GERC32-4.0	32	4.0	40.0	33.0	5 μ m	●
GERC32-5.0	32	5.0	40.0	33.0	5 μ m	●
GERC32-6.0	32	6.0	40.0	33.0	5 μ m	●
GERC32-7.0	32	7.0	40.0	33.0	5 μ m	●
GERC32-8.0	32	8.0	40.0	33.0	5 μ m	●
GERC32-9.0	32	9.0	40.0	33.0	5 μ m	●
GERC32-10.0	32	10.0	40.0	33.0	5 μ m	●
GERC32-11.0	32	11.0	40.0	33.0	5 μ m	●
GERC32-12.0	32	12.0	40.0	33.0	5 μ m	●
GERC32-13.0	32	13.0	40.0	33.0	5 μ m	●
GERC32-14.0	32	14.0	40.0	33.0	5 μ m	●
GERC32-15.0	32	15.0	40.0	33.0	5 μ m	●
GERC32-16.0	32	16.0	40.0	33.0	5 μ m	●
GERC32-17.0	32	17.0	40.0	33.0	5 μ m	●
GERC32-18.0	32	18.0	40.0	33.0	5 μ m	●
GERC32-19.0	32	19.0	40.0	33.0	5 μ m	●
GERC32-20.0	32	20.0	40.0	33.0	5 μ m	●
GERC40 GERC40-16.0	40	16.0	46.0	41.0	5 μ m	●
GERC40-20.0	40	20.0	46.0	41.0	5 μ m	●
GERC40-25.0	40	25.0	46.0	41.0	5 μ m	●

Order example • General type – Order as GERC16–6.0 • High precision type – Order as GERC16–6.0HP
• General-Sealed type – Order as GERC16–6.0C

(Unit : mm)

※ Please contact us about precision sealed type. ※ Please contact us about GERC40 precision type and other diameter.



GERC COLLET

GERC collet (precision type)

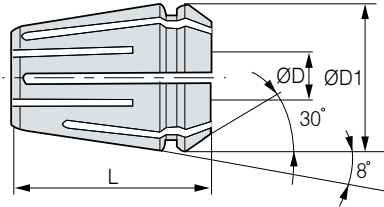
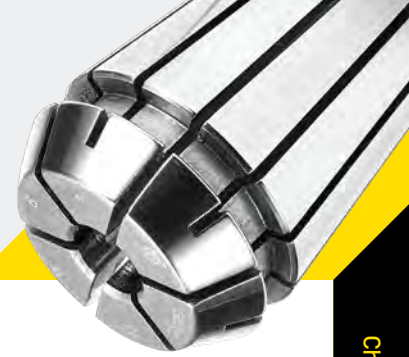

● : Stock

	Designation	ER Size	ØD	L	ØD1	Accuracy	Stock	
GERC11	GERC11-3.0HP	11.0	3.0	18.0	11.5	2µm	●	
	GERC11-4.0HP	11.0	4.0	18.0	11.5	2µm	●	
	GERC11-5.0HP	11.0	5.0	18.0	11.5	2µm	●	
	GERC11-6.0HP	11.0	6.0	18.0	11.5	2µm	●	
GERC16	GERC16-3.0HP	16.0	3.0	27.5	17.0	2µm	●	
	GERC16-4.0HP	16.0	4.0	27.5	17.0	2µm	●	
	GERC16-5.0HP	16.0	5.0	27.5	17.0	2µm	●	
	GERC16-6.0HP	16.0	6.0	27.5	17.0	2µm	●	
	GERC16-7.0HP	16.0	7.0	27.5	17.0	2µm	●	
	GERC16-8.0HP	16.0	8.0	27.5	17.0	2µm	●	
	GERC16-9.0HP	16.0	9.0	27.5	17.0	2µm	●	
	GERC16-10.0HP	16.0	10.0	27.5	17.0	2µm	●	
	GERC20	GERC20-3.0HP	20.0	3.0	31.5	21.0	2µm	●
		GERC20-4.0HP	20.0	4.0	31.5	21.0	2µm	●
GERC20-5.0HP		20.0	5.0	31.5	21.0	2µm	●	
GERC20-6.0HP		20.0	6.0	31.5	21.0	2µm	●	
GERC20-8.0HP		20.0	8.0	31.5	21.0	2µm	●	
GERC20-9.0HP		20.0	9.0	31.5	21.0	2µm	●	
GERC20-10.0HP		20.0	10.0	31.5	21.0	2µm	●	
GERC20-11.0HP		20.0	11.0	31.5	21.0	2µm	●	
GERC20-12.0HP		20.0	12.0	31.5	21.0	2µm	●	
GERC20-13.0HP		20.0	13.0	31.5	21.0	2µm	●	
GERC25	GERC25-6.0HP	25.0	6.0	34.0	26.0	2µm	●	
	GERC25-10.0HP	25.0	10.0	34.0	26.0	2µm	●	
	GERC25-12.0HP	25.0	12.0	34.0	26.0	2µm	●	
	GERC25-14.0HP	25.0	14.0	34.0	26.0	2µm	●	
	GERC25-16.0HP	25.0	16.0	34.0	26.0	2µm	●	
GERC32	GERC32-6.0HP	32.0	6.0	40.0	33.0	2µm	●	
	GERC32-10.0HP	32.0	10.0	40.0	33.0	2µm	●	
	GERC32-12.0HP	32.0	12.0	40.0	33.0	2µm	●	
	GERC32-16.0HP	32.0	16.0	40.0	33.0	2µm	●	
	GERC32-18.0HP	32.0	18.0	40.0	33.0	2µm	●	
	GERC32-20.0HP	32.0	20.0	40.0	33.0	2µm	●	

Order example • General type – Order as GERC16-6.0 • High precision type – Order as GERC16-6.0HP (Unit : mm)
• General-Sealed type – Order as GERC16-6.0C

※ Please contact us about precision sealed type. ※ Please contact us about GERC40 precision type and other diameter.

Chuck

Arbor/Modular

Boring tool

Angular head

cBN/PCD

TAUMAX

Other

1:1 CHAT



GERC COLLET

GERC collet (waterproof-type general type)

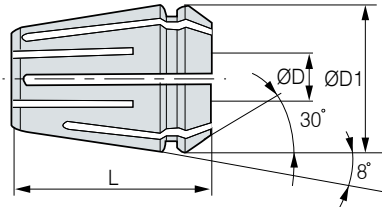
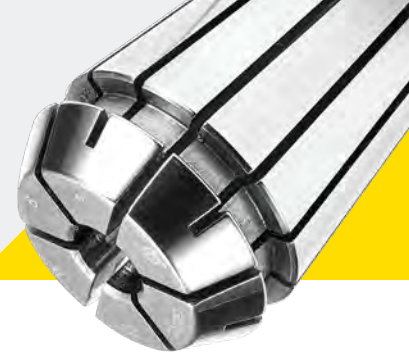

● : Stock

	Designation	ER Size	ØD	L	ØD1	Accuracy	Stock	
GERC16	GERC16-5.0C	16	5.0	27.5	17.0	5µm	●	
	GERC16-6.0C	16	6.0	27.5	17.0	5µm	●	
	GERC16-8.0C	16	8.0	27.5	17.0	5µm	●	
	GERC16-10.0C	16	10.0	27.5	17.0	5µm	●	
GERC20	GERC20-6.0C	20	6.0	31.5	21.0	5µm	●	
	GERC20-8.0C	20	8.0	31.5	21.0	5µm	●	
	GERC20-10.0C	20	10.0	31.5	21.0	5µm	●	
	GERC20-12.0C	20	12.0	31.5	21.0	5µm	●	
GERC25	GERC25-6.0C	25	6.0	34.0	26.0	5µm	●	
	GERC25-8.0C	25	8.0	34.0	26.0	5µm	●	
	GERC25-10.0C	25	10.0	34.0	26.0	5µm	●	
	GERC25-12.0C	25	12.0	34.0	26.0	5µm	●	
	GERC25-14.0C	25	14.0	34.0	26.0	5µm	●	
	GERC25-16.0C	25	16.0	34.0	26.0	5µm	●	
GERC32	GERC32-8.0C	32	8.0	40.0	33.0	5µm	●	
	GERC32-9.0C	32	9.0	40.0	33.0	5µm	●	
	GERC32-10.0C	32	10.0	40.0	33.0	5µm	●	
	GERC32-11.0C	32	11.0	40.0	33.0	5µm	●	
	GERC32-12.0C	32	12.0	40.0	33.0	5µm	●	
	GERC32-13.0C	32	13.0	40.0	33.0	5µm	●	
	GERC32-14.0C	32	14.0	40.0	33.0	5µm	●	
	GERC32-15.0C	32	15.0	40.0	33.0	5µm	●	
	GERC32-16.0C	32	16.0	40.0	33.0	5µm	●	
	GERC32-18.0C	32	18.0	40.0	33.0	5µm	●	
	GERC32-20.0C	32	20.0	40.0	33.0	5µm	●	

Order example • General type – Order as GERC16-6.0 • High precision type – Order as GERC16-6.0HP (Unit : mm)
 • General-Sealed type – Order as GERC16-6.0C

※ Please contact us about precision sealed type. ※ Please contact us about GERC40 precision type and other diameter.

1:1 CHAT



ER COLLET

ER collet (general type)

General
10 μ m

Run-out

ER collet

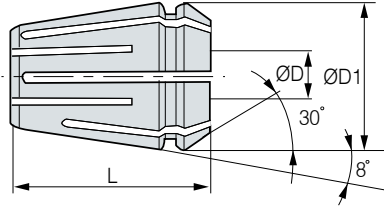

● : Stock

	Designation	ER Size	ØD	L	ØD1	Accuracy	Stock
ER11	ER11-1.0	11	1.0	18.0	11.5	10 μ m	●
	ER11-1.5	11	1.5	18.0	11.5	10 μ m	●
	ER11-2.0	11	2.0	18.0	11.5	10 μ m	●
	ER11-2.5	11	2.5	18.0	11.5	10 μ m	●
	ER11-3.0	11	3.0	18.0	11.5	10 μ m	●
	ER11-3.5	11	3.5	18.0	11.5	10 μ m	●
	ER11-4.0	11	4.0	18.0	11.5	10 μ m	●
	ER11-4.5	11	4.5	18.0	11.5	10 μ m	●
	ER11-5.0	11	5.0	18.0	11.5	10 μ m	●
	ER11-5.5	11	5.5	18.0	11.5	10 μ m	●
	ER11-6.0	11	6.0	18.0	11.5	10 μ m	●
	ER11-6.5	11	6.5	18.0	11.5	10 μ m	●
ER11-7.0	11	7.0	18.0	11.5	10 μ m	●	
ER16	ER16-1.0	16	1.0	27.5	17.0	10 μ m	●
	ER16-2.0	16	2.0	27.5	17.0	10 μ m	●
	ER16-3.0	16	3.0	27.5	17.0	10 μ m	●
	ER16-4.0	16	4.0	27.5	17.0	10 μ m	●
	ER16-5.0	16	5.0	27.5	17.0	10 μ m	●
	ER16-6.0	16	6.0	27.5	17.0	10 μ m	●
	ER16-7.0	16	7.0	27.5	17.0	10 μ m	●
	ER16-8.0	16	8.0	27.5	17.0	10 μ m	●
	ER16-9.0	16	9.0	27.5	17.0	10 μ m	●
	ER16-10.0	16	10.0	27.5	17.0	10 μ m	●
ER20	ER20-1.0	20	1.0	31.5	21.0	10 μ m	●
	ER20-2.0	20	2.0	31.5	21.0	10 μ m	●
	ER20-3.0	20	3.0	31.5	21.0	10 μ m	●
	ER20-4.0	20	4.0	31.5	21.0	10 μ m	●
	ER20-5.0	20	5.0	31.5	21.0	10 μ m	●
	ER20-6.0	20	6.0	31.5	21.0	10 μ m	●
	ER20-7.0	20	7.0	31.5	21.0	10 μ m	●
	ER20-8.0	20	8.0	31.5	21.0	10 μ m	●
	ER20-9.0	20	9.0	31.5	21.0	10 μ m	●
	ER20-10.0	20	10.0	31.5	21.0	10 μ m	●
	ER20-11.0	20	11.0	31.5	21.0	10 μ m	●
	ER20-12.0	20	12.0	31.5	21.0	10 μ m	●
	ER20-13.0	20	13.0	31.5	21.0	10 μ m	●

Order example • General type – Order using ER16-6.0 • General Sealed type – Order using ER16-6.0C

(Unit : mm)

※ Please contact us about other diameter.

※ The (C) type is a sealed ER collet.



ER COLLET

ER collet (general type)

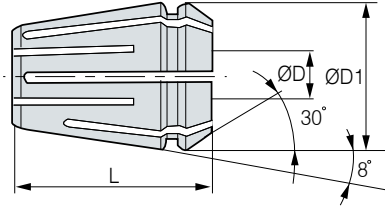

● : Stock

	Designation	ER Size	ØD	L	ØD1	Accuracy	Stock
ER25	ER25-2.0	25	2.0	34.0	26.0	10µm	●
	ER25-3.0	25	3.0	34.0	26.0	10µm	●
	ER25-4.0	25	4.0	34.0	26.0	10µm	●
	ER25-5.0	25	5.0	34.0	26.0	10µm	●
	ER25-6.0	25	6.0	34.0	26.0	10µm	●
	ER25-7.0	25	7.0	34.0	26.0	10µm	●
	ER25-8.0	25	8.0	34.0	26.0	10µm	●
	ER25-9.0	25	9.0	34.0	26.0	10µm	●
	ER25-10.0	25	10.0	34.0	26.0	10µm	●
	ER25-11.0	25	11.0	34.0	26.0	10µm	●
	ER25-12.0	25	12.0	34.0	26.0	10µm	●
	ER25-13.0	25	13.0	34.0	26.0	10µm	●
	ER25-14.0	25	14.0	34.0	26.0	10µm	●
	ER25-15.0	25	15.0	34.0	26.0	10µm	●
ER25-16.0	25	16.0	34.0	26.0	10µm	●	
ER32	ER32-2.0	32	2.0	40.0	33.0	10µm	●
	ER32-3.0	32	3.0	40.0	33.0	10µm	●
	ER32-4.0	32	4.0	40.0	33.0	10µm	●
	ER32-5.0	32	5.0	40.0	33.0	10µm	●
	ER32-6.0	32	6.0	40.0	33.0	10µm	●
	ER32-7.0	32	7.0	40.0	33.0	10µm	●
	ER32-8.0	32	8.0	40.0	33.0	10µm	●
	ER32-9.0	32	9.0	40.0	33.0	10µm	●
	ER32-10.0	32	10.0	40.0	33.0	10µm	●
	ER32-11.0	32	11.0	40.0	33.0	10µm	●
	ER32-12.0	32	12.0	40.0	33.0	10µm	●
	ER32-13.0	32	13.0	40.0	33.0	10µm	●
	ER32-14.0	32	14.0	40.0	33.0	10µm	●
	ER32-15.0	32	15.0	40.0	33.0	10µm	●
	ER32-16.0	32	16.0	40.0	33.0	10µm	●
	ER32-17.0	32	17.0	40.0	33.0	10µm	●
ER32-18.0	32	18.0	40.0	33.0	10µm	●	
ER32-19.0	32	19.0	40.0	33.0	10µm	●	
ER32-20.0	32	20.0	40.0	33.0	10µm	●	

Order example • General type – Order using ER16-6.0 • General Sealed type – Order using ER16-6.0C (Unit : mm)

※ Please contact us about other diameter.

※ The (C) type is a sealed ER collet.

Chuck

Arbor/Modular

Boring tool

Angular head

CBN/PCD

TAUMAX

Other

1:1 CHAT



ER COLLET

ER collet (sealed type)

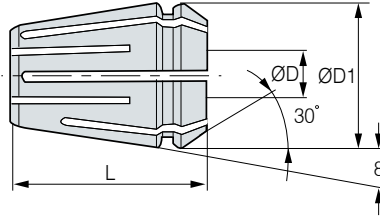

● : Stock

	Designation	ER Size	ØD	L	ØD1	Accuracy	Stock
ER16	ER16-5.0C	16	5.0	27.5	17.0	10µm	●
	ER16-6.0C	16	6.0	27.5	17.0	10µm	●
	ER16-8.0C	16	8.0	27.5	17.0	10µm	●
	ER16-10.0C	16	10.0	27.5	17.0	10µm	●
ER20	ER20-6.0C	20	6.0	31.5	21.0	10µm	●
	ER20-8.0C	20	8.0	31.5	21.0	10µm	●
	ER20-10.0C	20	10.0	31.5	21.0	10µm	●
	ER20-12.0C	20	12.0	31.5	21.0	10µm	●
ER25	ER25-6.0C	25	6.0	34.0	26.0	10µm	●
	ER25-8.0C	25	8.0	34.0	26.0	10µm	●
	ER25-10.0C	25	10.0	34.0	26.0	10µm	●
	ER25-12.0C	25	12.0	34.0	26.0	10µm	●
	ER25-14.0C	25	14.0	34.0	26.0	10µm	●
	ER25-16.0C	25	16.0	34.0	26.0	10µm	●
ER32	ER32-8.0C	32	8.0	40.0	33.0	10µm	●
	ER32-9.0C	32	9.0	40.0	33.0	10µm	●
	ER32-10.0C	32	10.0	40.0	33.0	10µm	●
	ER32-11.0C	32	11.0	40.0	33.0	10µm	●
	ER32-12.0C	32	12.0	40.0	33.0	10µm	●
	ER32-13.0C	32	13.0	40.0	33.0	10µm	●
	ER32-14.0C	32	14.0	40.0	33.0	10µm	●
	ER32-15.0C	32	15.0	40.0	33.0	10µm	●
	ER32-16.0C	32	16.0	40.0	33.0	10µm	●
	ER32-18.0C	32	18.0	40.0	33.0	10µm	●
	ER32-20.0C	32	20.0	40.0	33.0	10µm	●

Order example • General type – Order using ER16-6.0 • General Sealed type – Order using ER16-6.0C (Unit : mm)

※ Please contact us about other diameter.

※ The (C) type is a sealed ER collet.



ER/L

Lock collet for ER collet chuck



ER collet

Lock

Coolant System

Features

- Designed to prevent the end mill from falling out
- Prevents tool fallout, slipping, or idle running
- Uses the Weldon flat (DIN 6535HB) end mill without any special end mill
- Useful for machining large-sized mold or difficult-to-cut materials

NAMING

ER	20	—	12	—	L
ER collet	Collet size		Tool dia.		Lock



Structural Features

Designed to prevent fallout

- Tool fallout is prevented by a key inserted in the collet.
- A key is inserted to prevent the tool from pull out.

How to use

- Assemble the collet with nut (same for general ER collet in use)
- Assemble the end tool (in the direction of assembling notch with key)
- Tighten the nut with the body

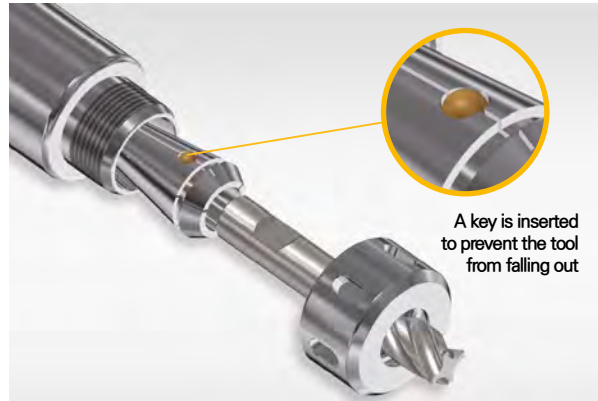

1

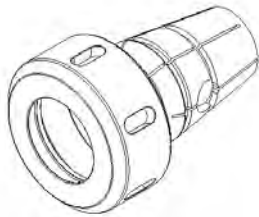

Combine the non-slip ER collet with nut.

2

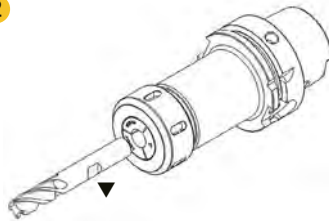

Clamp the nut after inserting no. 1 into the collet chuck. After that, insert the end mill notch to be aligned with the part ▼ [steel ball position].

3

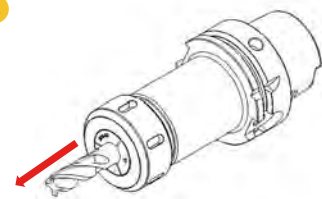

After checking that the steel ball in the collet is caught in the notched part, completely clamp the nut by pulling the end mill in the axial direction [arrow direction]

Note

If an auto clamp device is used, skip step 3. (End mill rotation may cause injury.)

Applicable end mill

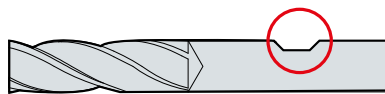

〈DIN6535 specifications end mill〉

※ Please refer to **105p** for detailed specifications.



ER/L

Lock collet for ER collet chuck

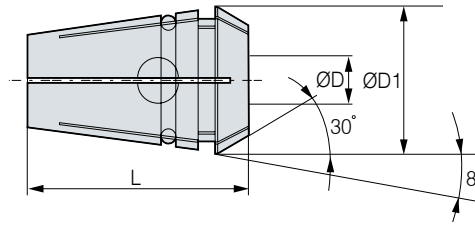

● : Stock

	Designation	ER Size	ØD	L	ØD1	Stock
ER20L	ER20-6L	20	6	31.5	20.7	●
	ER20-8L	20	8	31.5	20.7	●
	ER20-10L	20	10	31.5	20.7	●
	ER20-12L	20	12	31.5	20.7	●
ER32L	ER32-12L	32	12	40.0	32.7	●
	ER32-16L	32	16	40.0	32.7	●
	ER32-20L	32	20	40.0	32.7	●

※ For DIN ISO 15488-A standard

(Unit : mm)



Notched Endmill

Notched endmill

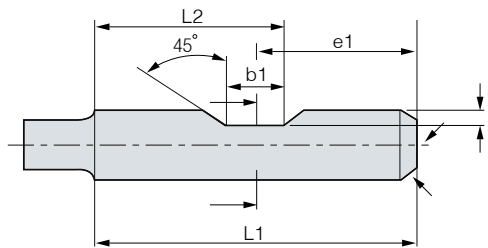

Tool Ø	Tool (DIN6535)				
	L1	e1	b1	L2	t
6	36	18	4.2	20.1	0.9
8	36	18	5.5	20.75	1.1
10	40	20	7	23.5	1.5
12	45	22.5	8	26.5	1.6
14	45	22.5	8	26.5	1.3
16	48	24	10	29	1.8
18	48	24	10	29	1.8
20	50	25	11	30.5	1.8
25	56	32	12	30	2.0
32	60	36	14	31	2.0

※ DIN 6535HB standard end mill used

※Not supplied with ER/L collet.

(Unit : mm)

Chuck

Arbor/Modular

Boring tool

Angular head

CBN/PCD

TAUMAX

Other



RTJW

Jet coolant disk



Jet coolant Inside coolant

Features

- Provides a longer cutting tool life by preventing chips from adhering to the tool
- Improves chip breakability/breaking strong jet injection
- Reduces equipment non-operation time as nozzle position change is not necessary



NAMING

RTJW	16	—	6
Jet coolant disk	Nut size		Tool dia.

Application

- With one waterproof type (RT, RUT) NUT, the inside jet coolant is simultaneously used
- Enables a fast change of the inside jet coolant only by disk replacement
- Strong jet injection with no scattering even in the high-speed rotation

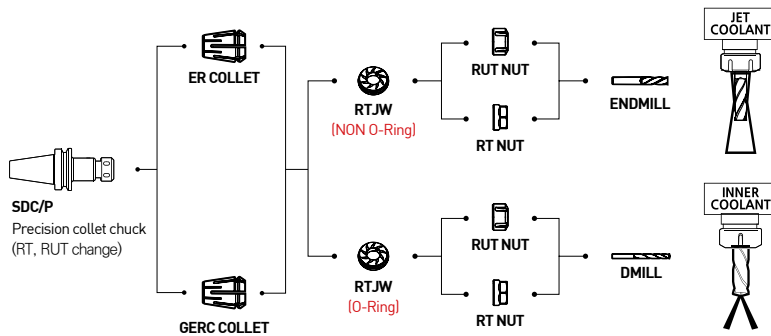

RT NUT

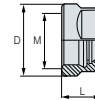

Type	M	D	L
RT16	M22x1.50	28.0	22.5

RUT NUT

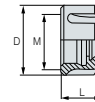

Type	M	D	L
RUT20	M25x1.50	35.0	24.0
RUT25	M32x1.50	42.0	25.0
RUT32	M40x1.50	50.0	27.5
RUT40	M50x1.50	63.0	30.5

Type	Pocket machining	After	Remarks
JET COOLANT			• The chips in the pocket completely are removed by a strong jet injection.
OUTSIDE COOLANT			• The chips in the pocket are not removed. • Chips are accumulated in the collet and nut.

Coolant method

According to use, inside coolant and jet coolant refueling can be used.

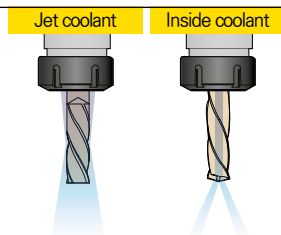

Mixing prevention

Effective for vibration proof by preventing mixing of cutting chips by using RTJW.

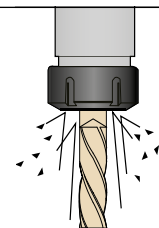



RTJW

Jet coolant disk



- : To be discontinued
- : Stock

※ We do not manufacture less than $\varnothing 5$

- For more information on the product features, see **106p**.
- For more information on the products to be tightened, see **86p**.

	Designation	ER Size	Inner diameter	Available Nuts	Stock	
RTJW16	RTJW16-6	16	6	RUT16	●	
	RTJW16-7	16	7	RUT16	●	
	RTJW16-8	16	8	RUT16	●	
RTJW20	RTJW20-6	20	6	RUT20	●	
	RTJW20-7	20	7	RUT20	●	
	RTJW20-8	20	8	RUT20	●	
	RTJW20-9	20	9	RUT20	●	
	RTJW20-10	20	10	RUT20	●	
RTJW25	RTJW25-6	25	6	RUT25	●	
	RTJW25-7	25	7	RUT25	●	
	RTJW25-8	25	8	RUT25	●	
	RTJW25-9	25	9	RUT25	●	
	RTJW25-10	25	10	RUT25	●	
	RTJW25-11	25	11	RUT25	●	
	RTJW25-12	25	12	RUT25	●	
	RTJW25-13	25	13	RUT25	●	
	RTJW25-14	25	14	RUT25	●	
	RTJW25-15	25	15	RUT25	●	
	RTJW25-16	25	16	RUT25	●	

(Unit : mm)

	Designation	ER Size	Inner diameter	Available Nuts	Stock
RTJW32	RTJW32-6	32	6	RUT32	●
	RTJW32-7	32	7	RUT32	●
	RTJW32-8	32	8	RUT32	●
	RTJW32-9	32	9	RUT32	●
	RTJW32-10	32	10	RUT32	●
	RTJW32-11	32	11	RUT32	●
	RTJW32-12	32	12	RUT32	●
	RTJW32-13	32	13	RUT32	●
	RTJW32-14	32	14	RUT32	●
	RTJW32-15	32	15	RUT32	●
	RTJW32-16	32	16	RUT32	●
	RTJW32-17	32	17	RUT32	●
RTJW40	RTJW40-18	40	18	RUT40	●
	RTJW40-19	40	19	RUT40	●
	RTJW40-20	40	20	RUT40	●
	RTJW40-21	40	21	RUT40	●
	RTJW40-22	40	22	RUT40	●
	RTJW40-24	40	24	RUT40	●

(Unit : mm)

Chuck
Arbor/Modular
Boring tool
Angular head
CBN/PCD
TAUMAX
Other

1:1 CHAT



DSK

Slim type collet chuck



G6.3

G value

15,000

Max RPM

Ø25

Max Dia

C

Coolant System

HC

HC collet

Milling

Milling

Drilling

Drilling

Features

- Enables balanced G6.3/ a maximum of 15,000RPM machining
- Minimized tool vibration during machining by adopting an 8-degree collet
- Provides optimal machining stability by applying Swiss Made nuts
- Tool clamping range : Ø2~Ø25

NAMING

BT30

Spindle

DSK

Slim Type
Collet Chuck

10

Tool dia.

90



Length

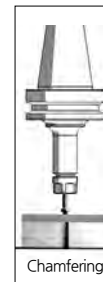
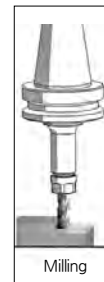
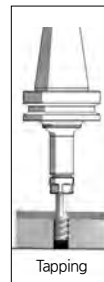
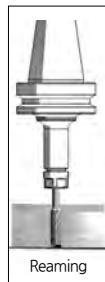
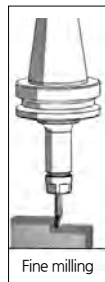
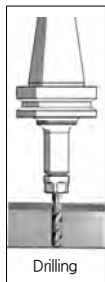

Multipurpose operation



Collet

General type & Precision type	Designation	Max Chacking	Run-out	8° HC Collet
	HC6 - ØD	6.0	General type 5µm	 <p>8°</p> <p>Minimizes tool vibration during machining</p>
	HC10 - ØD	10.0		
	HC13 - ØD	13.0	Precision type 3µm	
	HC16 - ØD	16.0		
	HC20 - ØD	20.0		
	HC25 - ØD	25.0		

Spanner (Accessories)

Spanner	Designation	Chuck
	DSS - 6	DSK 6
	DSS - 10	DSK 10
	DSS - 13	DSK 13
	DSS - 16	DSK 16
	DSS - 20	DSK 20
	DSS - 25	DSK 25

Collet extract tool

Collet Extractor	Designation	Chuck
	DSK - 6CE	DSK 6
	DSK - 10CE	DSK 10
	DSK - 13CE	DSK 13
	DSK - 16CE	DSK 16
	DSK - 20CE	DSK 20
	DSK - 25CE	DSK 25



BT-DSK

Slim type collet chuck



MAS 403-BT	G6.3	15,000	Ø25	C	HC	Milling	Drilling
Shank	G value	Max RPM	Max Dia	Coolant System	HC collet		

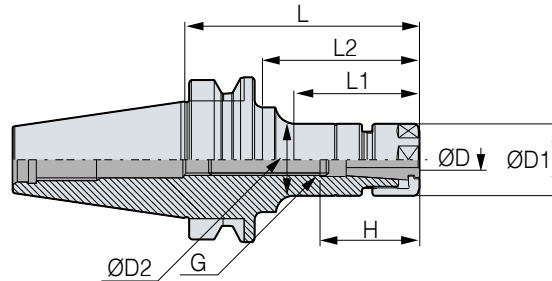

● : Stock

C Internal coolant system is optional

※ Sealed collet is used when applying internal coolant

• For more information on the product features, see **108p**.

• For more information on the related parts, see **111p**.

• For more information on the applicable collet, see **118p**.

	Designation	ØD	L	ØD1	ØD2	L1	L2	H	COLLET	G	RPM	Kg	Package weight(Kg)	Stock
BT30	BT30-DSK6-60	3.0~6.0	60	20	20	33	33	31	HC6	M8	15,000	0.4	0.5	●
	BT30-DSK6-90	3.0~6.0	90	20	32	56	65	31	HC6	M8	15,000	0.5	0.6	●
	BT30-DSK10-60	2.0~10.0	60	28	28	35	35	38	HC10	M12	15,000	0.5	0.6	●
	BT30-DSK10-90	2.0~10.0	90	28	28	65	65	38	HC10	M12	15,000	0.6	0.7	●
	BT30-DSK10-120	2.0~10.0	120	28	28	95	95	38	HC10	M12	15,000	1.1	1.1	
	BT30-DSK13-60	3.0~13.0	60	33	33	36	36	43	HC13	M12	15,000	0.5	0.6	●
	BT30-DSK16-60	3.0~16.0	60	40	40	37	37	52	HC16	M12	15,000	0.6	0.7	●
	BT30-DSK16-90	3.0~16.0	90	40	40	67	67	52	HC16	M18	15,000	0.8	0.9	●
	BT30-DSK16-120	3.0~16.0	120	40	40	97	97	60	HC16	M18	15,000	1.1	1.1	
	BT30-DSK20-75	4.0~12.0	75	48	48	52	52	70	HC20	M12	15,000	1.1	1.1	
BT30-DSK20-90	4.0~12.0	90	48	48	52	52	07	HC20	M18	15,000	1.2	1.2		
BT30-DSK25-90	16.0~25.0	90	55	55	67.5	67.5	63.5	HC25	M12	15,000	0.9	1.1	●	
BT40	BT40-DSK6-60	1.0~6.0	60	20	20	30	30	35	HC6	M8	10,000	1.0	1.0	
	BT40-DSK6-90	3.0~6.0	90	20	32	51	61	31	HC6	M8	10,000	1.1	1.3	●
	BT40-DSK6-120	3.0~6.0	120	20	32	60	90	31	HC6	M8	10,000	1.1	1.3	●
	BT40-DSK6-150	3.0~6.0	150	20	25	60	120	31	HC6	M8	10,000	1.1	1.4	●
	BT40-DSK10-60	2.0~6.0	60	28	28	32	32	50	HC10	M12	10,000	1.1	1.1	
	BT40-DSK10-90	2.0~10.0	90	28	40	48	60	38	HC10	M12	10,000	1.2	1.4	●
	BT40-DSK10-120	2.0~10.0	120	28	40	73	90	38	HC10	M12	10,000	1.2	1.5	●
	BT40-DSK10-150	2.0~10.0	150	28	35	73	118	38	HC10	M12	10,000	1.4	1.7	●
	BT40-DSK10-180	2.0~10.0	180	28	39	73	148	50	HC10	M10	10,000	1.4	1.7	
	BT40-DSK13-90	3.0~13.0	90	33	33	59	59	43	HC13	M15	10,000	1.3	1.5	●
	BT40-DSK16-60	3.0~16.0	60	40	40	32	32	60	HC16	M18	10,000	1.3	1.5	
	BT40-DSK16-90	3.0~16.0	90	40	40	58	58	52	HC16	M18	10,000	1.3	1.5	●
	BT40-DSK16-120	3.0~16.0	120	40	40	88	88	52	HC16	M18	10,000	1.5	1.7	●
	BT40-DSK16-150	3.0~16.0	150	40	40	118	118	52	HC16	M18	10,000	1.9	2.1	●
	BT40-DSK16-180	3.0~16.0	180	40	40	148	148	60	HC16	M18	10,000	1.9	2.1	
	BT40-DSK20-60	4.0~20.0	60	48	48	32	32	70	HC20	M22	10,000	1.5	1.7	
	BT40-DSK20-90	4.0~20.0	90	49	49	60	60	60	HC20	M22	10,000	1.5	1.7	●
	BT40-DSK20-120	4.0~20.0	120	49	49	90	90	60	HC20	M22	10,000	1.8	2.0	●
BT40-DSK25-90	16.0~25.0	90	55	55	61	61	63.5	HC25	M28	10,000	1.6	1.8	●	
BT40-DSK25-120	16.0~25.0	120	55	55	91	91	85	HC25	M28	10,000	2.0	2.3	●	

(Unit : mm)

Chuck

Arbor/Modular

Boring tool

Angular head

cBN/PCD

TAUMAX

Other

1:1 CHAT



BT-DSK

Slim type collet chuck



MAS 403-BT
G6.3
8,000
Ø25
C
HC
Milling
Drilling

Shank G value Max RPM Max Dia Coolant System HC collet Milling Drilling

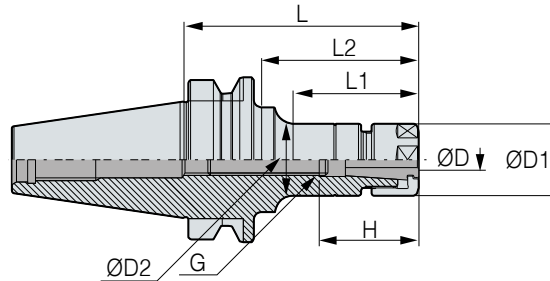

● : Stock

C Internal coolant system is optional

※ Sealed collet is used when applying internal coolant

• For more information on the product features, see **108p**

• For more information on the related parts, see **111p**

• For more information on the applicable collet, see **118p**

	Designation	ØD	L	ØD1	ØD2	L1	L2	H	COLLET	G	RPM	Kg	Package weight(Kg)	Stock
BT50	BT50-DSK6-105	3.0~6.0	105	20	32	55	64	31	HC6	M8	8,000	3.6	3.9	●
	BT50-DSK6-135	3.0~6.0	135	20	32	60	92	31	HC6	M8	8,000	3.7	4.1	●
	BT50-DSK6-165	3.0~6.0	165	20	32	60	114	31	HC6	M8	8,000	4.1	4.4	●
	BT50-DSK10-105	2.0~10.0	105	28	27.5	57	57	38	HC10	M12	8,000	3.8	4.1	●
	BT50-DSK10-135	2.0~10.0	135	28	32	70	92	38	HC10	M12	8,000	3.9	4.3	●
	BT50-DSK10-165	2.0~10.0	165	28	36	75	114	38	HC10	M12	8,000	4.1	4.5	●
	BT50-DSK10-195	2.0~10.0	195	28	36	75	146	38	HC10	M12	8,000	4.5	4.8	
	BT50-DSK13-135	3.0~13.0	135	33	33	92	92	43	HC13	M15	8,000	3.8	4.2	●
	BT50-DSK16-105	3.0~16.0	105	40	40	62	62	52	HC16	M18	8,000	4.0	4.3	●
	BT50-DSK16-135	3.0~16.0	135	40	40	92	92	52	HC16	M18	8,000	4.2	4.6	●
	BT50-DSK16-165	3.0~16.0	165	40	50	40	122	52	HC16	M18	8,000	4.6	5.0	●
	BT50-DSK16-195	3.0~16.0	195	40	52	40	152	60	HC16	M18	8,000	4.6	5.0	
	BT50-DSK20-105	4.0~20.0	105	48	40	62	62	60	HC20	M22	8,000	4.2	4.5	●
	BT50-DSK20-135	4.0~20.0	135	48	40	92	92	60	HC20	M22	8,000	4.5	4.9	●
	BT50-DSK20-165	4.0~20.0	165	48	40	122	122	60	HC20	M22	8,000	4.9	5.3	●
	BT50-DSK25-105	16.0~25.0	105	55	55	62	62	64	HC25	M28	8,000	4.4	4.7	●
	BT50-DSK25-135	16.0~25.0	135	55	55	92	92	64	HC25	M28	8,000	4.5	4.9	●
	BT50-DSK25-165	16.0~25.0	165	55	55	122	122	64	HC25	M28	8,000	5.2	5.6	●

(Unit : mm)



DSK SPARE PART

Slim collet chuck related parts



Main components

SPARE PART	Type	Main components		
		Nut	Adjust screw	Extraction tool
	Images			
	Model No.			
	DSK6	DN6	BN0825	DSK-6CE
	DSK10	DN10	BN1230	DSK-10CE
	DSK13	DN13	BN1230(BT30) / BN1524F(그외)	DSK-13CE
	DSK16	DN16	BN1830F	DSK-16CE
	DSK20	DN20	BN2230F	DSK-20CE
	DSK25	DN25	BN2838F	DSK-25CE

※ BN1230 screws are used for BT30-DSK25-90

Accessories

SPARE PART	Spanner		Designation	Chuck
			DSS-6	DSK6
DSS-10	DSK10			
DSS-13	DSK13			
DSS-16	DSK16			
DSS-20	DSK20			
DSS-25	DSK25			



HC COLLET

HC Slim collet (General & precision type)



Accessories

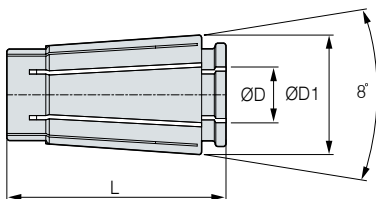

SPARE PART	Designation	ØD1	L	MAX. ØD	Clearance	General	Precision(P)
	HC6 ØD(P)	10.5	25.0	6.0	1.0	5µm	3µm
HC10 ØD(P)	15.6	30.5	10.0	1.0	5µm	3µm	
HC13 ØD(P)	20.1	39.0	13.0	1.0	5µm	3µm	
HC16 ØD(P)	24.6	45.0	16.0	1.0	5µm	3µm	
HC20 ØD(P)	29.2	54.3	20.0	1.0	5µm	3µm	
HC25 ØD(P)	35.7	57.0	25.0	1.0	5µm	3µm	

• For more information on the detailed specifications, see **118p**. (Unit : mm)

- Order example**
- General type – Order as HC16-8.0
 - Precision type – Order as HC16-8.0P

1:1 CHAT



GSK

Great speed slim collet chuck



Features

- Enables balanced G2.5/ a maximum of 25,000RPM machining
- Improves machining productivity by high-speed machining
- Minimized tool vibration during machining by adopting an 8-degree collet
- The collet is pressed steadily by the Swiss Made high-accuracy nut.
- Optimal machining stability
- Tool clamping range : Ø2~Ø25

NAMING

BT40	GSK	10	90
Spindle	Great Speed Slim collet chuck	Tool dia.	Length



Unique Design

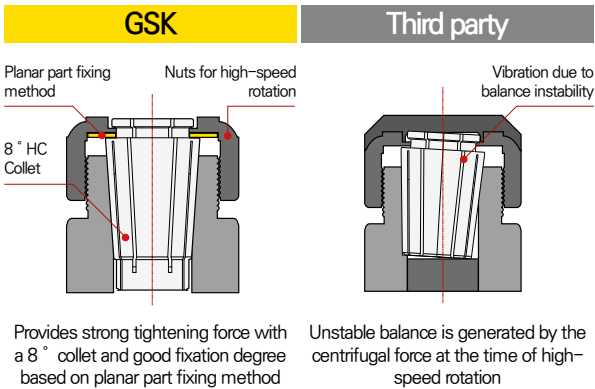

Comparison of screw polishing at points of nut tightened

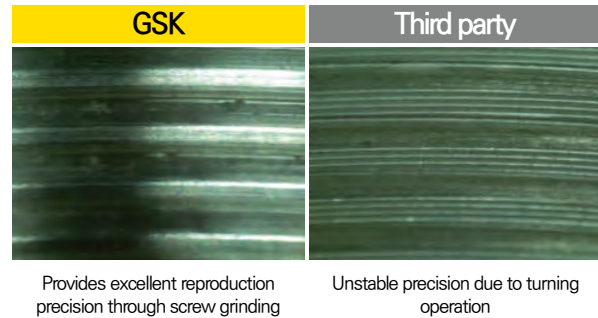

Special Design

Optimized for great-speed collet chucks and uniquely designed to enable easy runout measurement by designating the test bar area to the product

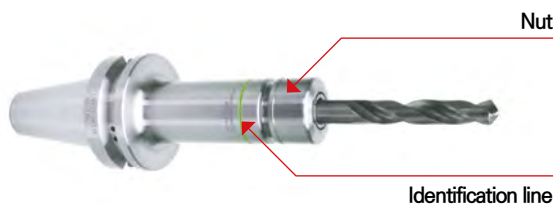

C Internal coolant system is optional

Spanner (optional)



Designation	GSK
GSK6 SPANNER	GSK6
GSK10 SPANNER	GSK10
GSK13 SPANNER	GSK13
GSK16 SPANNER	GSK16
GSK20 SPANNER	GSK20
GSK25 SPANNER	GSK25



BT-GSK

Great slim type collet chuck



MAS 403-BT	G2.5	25,000	Ø25	C	HC	Milling	Drilling
Shank	G value	Max RPM	Max Dia	Coolant System	HC collet	Milling	Drilling

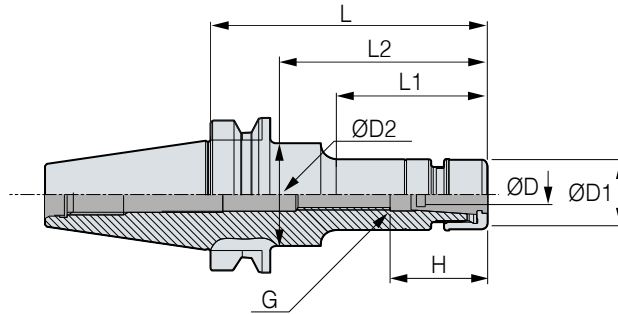

● : Stock

C Internal coolant system is optional

※ Sealed collet is used when applying internal coolant

• For more information on the product features, see **112p**

• For more information on the related parts, see **117p**

• For more information on the applicable collet, see **118p**

	Designation	ØD	L	ØD1	ØD2	L1	L2	H	COLLET /STEP	G	RPM	kg	Package weight(Kg)	Stock
BT30	BT30-GSK6-60	3.0~6.0	60	20	20	33	33	31	HC6/1.0	M8	25,000	0.4	0.4	●
	BT30-GSK6-90	3.0~6.0	90	20	32	56	65	31	HC6/1.0	M8	25,000	0.5	0.6	●
	BT30-GSK10-60	2.0~10.0	60	27	27	35	35	38	HC10/1.0	M12	25,000	0.5	0.6	●
	BT30-GSK10-90	2.0~10.0	90	27	27	65	65	38	HC10/1.0	M12	25,000	0.6	0.7	●
	BT30-GSK13-60	3.0~13.0	60	35	35	36	36	43	HC13/1.0	M12	25,000	0.6	0.7	●
	BT30-GSK16-60	3.0~16.0	60	40	40	37	37	52	HC16/1.0	M12	25,000	0.6	0.7	●
	BT30-GSK16-90	3.0~16.0	90	40	40	67	67	52	HC16/1.0	M18	25,000	0.8	0.9	●
	BT30-GSK25-90	16.0~25.0	90	55	55	68	68	64	HC25/1.0	M12	25,000	1.0	1.1	●
BT40	BT40-GSK6-90	3.0~6.0	90	20	32	51	61	31	HC6/1.0	M8	20,000	1.0	1.2	●
	BT40-GSK6-120	3.0~6.0	120	20	32	60	90	31	HC6/1.0	M8	20,000	1.2	1.5	●
	BT40-GSK6-150	3.0~6.0	150	20	25	60	120	31	HC6/1.0	M8	20,000	1.2	1.4	●
	BT40-GSK10-90	2.0~10.0	90	27	40	48	60	38	HC10/1.0	M12	20,000	1.1	1.3	●
	BT40-GSK10-120	2.0~10.0	120	27	40	73	90	38	HC10/1.0	M12	20,000	1.3	1.5	●
	BT40-GSK10-150	2.0~10.0	150	27	65	73	118	38	HC10/1.0	M12	20,000	1.4	1.6	●
	BT40-GSK13-90	3.0~13.0	90	35	35	59	59	43	HC13/1.0	M15	20,000	1.2	1.4	●
	BT40-GSK16-90	3.0~16.0	90	40	40	58	58	52	HC16/1.0	M18	20,000	1.3	1.5	●
	BT40-GSK16-120	3.0~16.0	120	40	40	88	88	52	HC16/1.0	M18	20,000	1.5	1.7	●
	BT40-GSK16-150	3.0~16.0	150	40	40	118	118	52	HC16/1.0	M18	20,000	1.8	2.0	●
	BT40-GSK20-90	4.0~20.0	90	48	48	60	60	60	HC20/1.0	M22	20,000	1.4	1.6	●
	BT40-GSK20-120	4.0~20.0	120	48	48	90	90	60	HC20/1.0	M22	20,000	1.8	2.0	●
	BT40-GSK25-90	16.0~25.0	90	55	55	61	61	64	HC25/1.0	M28	20,000	1.6	1.8	●
	BT40-GSK25-120	16.0~25.0	120	55	55	91	91	64	HC25/1.0	M28	20,000	2.0	2.2	●

(Unit : mm)

Chuck
Arbor/Modular
Boring tool
Angular head
CBN/PCD
TAUMAX
Other

1:1 CHAT



BT-GSK

Great slim type collet chuck



MAS 403-BT	G2.5	15,000	Ø25	C	HC	Milling	Drilling
Shank	G value	Max RPM	Max Dia	Coolant System	HC collet	Milling	Drilling

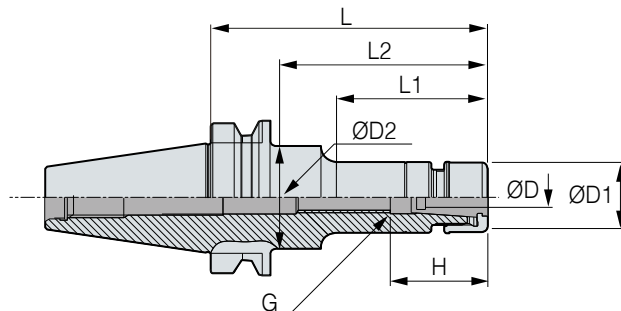

● : Stock

C Internal coolant system is optional

※ Sealed collet is used when applying internal coolant

- For more information on the product features, see **112p**.
- For more information on the related parts, see **117p**.
- For more information on the applicable collet, see **118p**.

	Designation	ØD	L	ØD1	ØD2	L1	L2	H	COLLET /STEP	G	RPM	Kg	Package weight(Kg)	Stock
BT50	BT50-GSK6-105	3.0~6.0	105	20	32	55	64	31	HC6	M8	15,000	3.6	3.9	●
	BT50-GSK6-135	3.0~6.0	135	20	32	60	92	31	HC6	M8	15,000	3.6	4.0	●
	BT50-GSK6-165	3.0~6.0	165	20	32	60	114	31	HC6	M8	15,000	3.9	4.3	●
	BT50-GSK10-105	2.0~10.0	105	27	27	57	57	38	HC10	M12	15,000	3.7	4.0	●
	BT50-GSK10-135	2.0~10.0	135	27	32	70	92	38	HC10	M12	15,000	3.7	4.1	●
	BT50-GSK10-165	2.0~10.0	165	27	36	75	114	38	HC10	M12	15,000	4.0	4.4	●
	BT50-GSK13-135	3.0~13.0	135	35	35	92	92	43	HC13	M15	15,000	3.9	4.3	●
	BT50-GSK16-105	3.0~16.0	105	40	40	62	62	52	HC16	M18	15,000	3.9	4.2	●
	BT50-GSK16-135	3.0~16.0	135	40	40	92	92	52	HC16	M18	15,000	4.1	4.5	●
	BT50-GSK16-165	3.0~16.0	165	40	50	40	122	52	HC16	M18	15,000	4.3	4.7	●
	BT50-GSK20-105	4.0~20.0	105	48	-	-	62	60	HC20	M22	15,000	4.1	4.4	●
	BT50-GSK20-135	4.0~20.0	135	48	-	-	92	60	HC20	M22	15,000	4.4	4.8	●
	BT50-GSK20-165	4.0~20.0	165	48	-	-	122	60	HC20	M22	15,000	4.9	5.1	●
	BT50-GSK25-105	16.0~25.0	105	55	55	62	62	64	HC25	M28	15,000	4.2	4.5	●
	BT50-GSK25-135	16.0~25.0	135	55	55	92	92	64	HC25	M28	15,000	4.6	5.0	●
	BT50-GSK25-165	16.0~25.0	165	55	55	122	122	64	HC25	M28	15,000	5.1	5.5	●

(Unit : mm)



HSK-GSK

Great slim type collet chuck



DIN 69893-1	G2.5	20,000	Ø25	C	HC	Milling	Drilling
Shank	G value	Max RPM	Max Dia	Coolant System	HC collet		

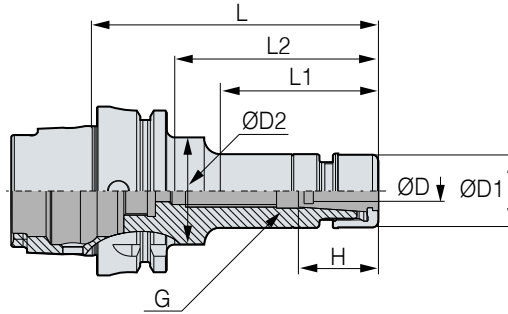

- : Stock
- C Internal coolant system is optional
- ※ Sealed collet is used when applying internal coolant

- For more information on the product features, see **112p**.
- For more information on the related parts, see **117p**.
- For more information on the applicable collet, see **118p**.

	Designation	ØD	L	ØD1	ØD2	L1	L2	H	COLLET /STEP	G	RPM	kg	Package weight(Kg)	Stock
HSK63A	HSK63A-GSK6-100	3.0~6.0	100	20	32	51	71	31	HC6	M8	20,000	0.8	1.0	●
	HSK63A-GSK10-105	2.0~10.0	105	27	35	60	76	38	HC10	M12	20,000	0.9	1.2	●
	HSK63A-GSK16-120	3.0~16.0	120	40	40	90	-	52	HC16	M18	20,000	1.3	1.5	●
	HSK63A-GSK20-120	4.0~20.0	120	48	48	92	-	60	HC20	M22	20,000	1.6	1.8	●
HSK100A	HSK100A-GSK6-120	3.0~6.0	120	19.5	32	70	88	31	HC6	M8	15,000	2.2	2.6	●
	HSK100A-GSK10-120	2.0~10.0	120	27	27	70	88	38	HC10	M12	15,000	2.3	2.7	●
	HSK100A-GSK16-140	3.0~16.0	140	40	40	105	-	52	HC16	M18	15,000	2.8	3.1	●
	HSK100A-GSK25-155	16.0~25.0	155	55	55	120	-	64	HC25	M28	15,000	3.6	4.0	●

(Unit : mm)

Accessories

SPARE PART	Type	Accessories
	Images	Coolant tube for HSK
Model No.		
	HSK63A	HSK63A-CNS
	HSK100A	HSK100A-CNS



SK-GSK

Great slim type collet chuck



DIN69871 -1A/B	G2.5	20,000	Ø25	C	HC	Milling	Drilling
Shank	G value	Max RPM	Max Dia	Coolant System	HC collet		

Fig.1

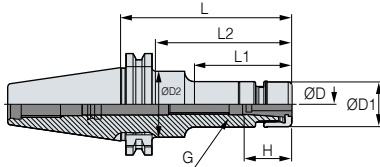

Fig.2

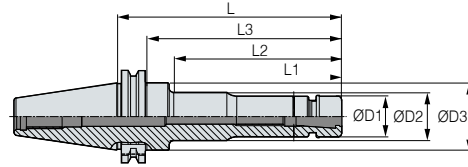
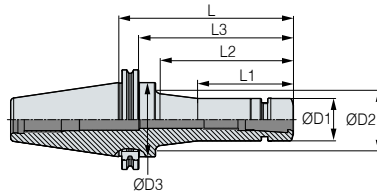

Fig.3



● : Stock

C Internal coolant system is optional

※ Sealed collet is used when applying internal coolant

- For more information on the product features, see **112p**.
- For more information on the related parts, see **117p**.
- For more information on the applicable collet, see **118p**.

	Designation	ØD	L	ØD1	ØD2	ØD3	L1	L2	L3	H	COLLET	G	RPM	Fig.	Kg	Package weight[Kg]	Stock	
SK40	SK40-GSK6-60	3.0~6.0	60	20	-	-	41	-	-	31	HC6	M8	20,000	1	0.8	1.0	●	
	SK40-GSK6-90	3.0~6.0	90	20	45	-	48	71	-	31	HC6	M8	20,000	1	1.0	1.2	●	
	SK40-GSK10-90	2.0~10.0	90	27	45	-	50	71	-	38	HC10	M12	20,000	1	1.1	1.3	●	
	SK40-GSK10-150	2.0~10.0	150	27	32	45	70	112	131	38	HC10	M12	20,000	2	1.3	1.6	●	
	SK40-GSK16-90	3.0~16.0	90	40	-	-	68	-	-	52	HC16	M18	20,000	1	1.2	1.4	●	
	SK40-GSK16-150	3.0~16.0	150	40	45	-	114	118	-	52	HC16	M18	20,000	1	1.7	2.0	●	
	SK40-GSK20-90	4.0~20.0	90	48	-	-	71	-	-	60	HC20	M22	20,000	1	1.3	1.5	●	
	SK40-GSK25-90	16.0~25.0	90	55	-	-	71	-	-	64	HC25	M28	20,000	1	1.3	1.5	●	
SK50	SK50-GSK6-105	3.0~6.0	105	20	70	-	60	86	-	31	HC6	M8	15,000	1	3.1	3.4	●	
	SK50-GSK6-165	3.0~6.0	165	20	32	70	60	120	15	31	HC6	M8	15,000	2	3.3	3.7	●	
	SK50-GSK10-105	2.0~10.0	105	27	70	-	65	86	-	38	HC10	M12	15,000	1	3.2	3.5	●	
	SK50-GSK10-165	2.0~10.0	165	27	32	70	75	120	15	38	HC10	M12	15,000	2	3.4	3.8	●	
	SK50-GSK16-105	3.0~16.0	105	40	70	-	65	86	-	52	HC16	M18	15,000	1	3.4	3.7	●	
	SK50-GSK16-165	3.0~16.0	165	40	50	70	90	126	15	52	HC16	M18	15,000	3	3.9	4.3	●	
	SK50-GSK20-105	4.0~10.0	105	48	70	-	65	86	-	60	HC20	M22	15,000	1	3.6	3.9	●	
	SK50-GSK20-165	4.0~10.0	165	48	70	-	125	146	-	60	HC20	M22	15,000	1	4.3	4.7	●	
	SK50-GSK25-105	16.0~25.0	105	55	70	-	65	86	-	64	HC25	M28	15,000	1	3.7	4.0	●	
	SK50-GSK25-165	16.0~25.0	165	55	70	-	125	146	-	64	HC25	M28	15,000	1	4.6	5.0	●	

(Unit : mm)



GSK SPARE PART

Great speed slim collet chuck related parts



Main components

SPARE PART	Type	Main components		
		Nut	Adjustment screw	Extraction tool
	Images			
	Model No.			
	GSK6	GN6	BN0825	DSK-6CE
	GSK10	GN10	BN1230	DSK-10CE
	GSK13	GN13	BN1230(BT30)/BN1524F(그외)	DSK-13CE
	GSK16	GN16	BN1830F	DSK-16CE
	GSK20	GN20	BN2230F	DSK-20CE
	GSK25	GN25	BN2838F	DSK-25CE

Accessories

SPARE PART	Spanner	Applicable chuck	
		Spanner Model No.	
		GSK6	GSK6 SPANNER
		GSK10	GSK10 SPANNER
		GSK13	GSK13 SPANNER
		GSK16	GSK16 SPANNER
		GSK20	GSK20 SPANNER
		GSK25	GSK25 SPANNER



HC COLLET

HC Slim collet (General & precision type)

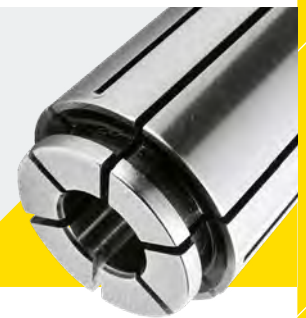

Accessories

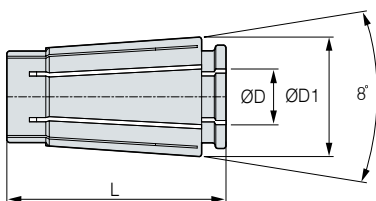

SPARE PART	Designation	ØD1	L	MAX. ØD	Clearance	General	Precision(P)
		HC6 ØD(P)	10.5	25.0	6.0	1.0	5µm
	HC10 ØD(P)	15.6	30.5	10.0	1.0	5µm	3µm
	HC13 ØD(P)	20.1	39.0	13.0	1.0	5µm	3µm
	HC16 ØD(P)	24.6	45.0	16.0	1.0	5µm	3µm
	HC20 ØD(P)	29.2	54.3	20.0	1.0	5µm	3µm
	HC25 ØD(P)	35.7	57.0	25.0	1.0	5µm	3µm

• For more information on the detailed specifications, see **118p**. (Unit : mm)

- Order example**
- General type – Order as HC16-8.0
 - Precision type – Order as HC16-8.0P



HC COLLET

HC Slim collet (general type)

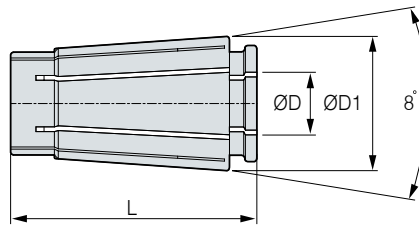
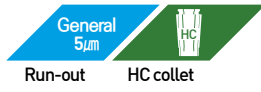
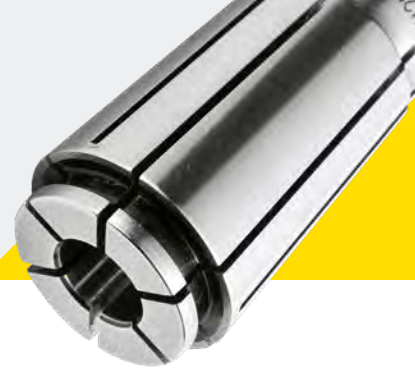

● : Stock

	Designation	ØD	L	ØD1	Clearance	Accuracy	Stock
HC6	HC6-3.0	3.0	25.0	10.5	1.0	5 μ m	●
	HC6-4.0	4.0	25.0	10.5	1.0	5 μ m	●
	HC6-5.0	5.0	25.0	10.5	1.0	5 μ m	●
	HC6-6.0	6.0	25.0	10.5	1.0	5 μ m	●
HC10	HC10-2.0	2.0	30.5	15.6	1.0	5 μ m	●
	HC10-3.0	3.0	30.5	15.6	1.0	5 μ m	●
	HC10-4.0	4.0	30.5	15.6	1.0	5 μ m	●
	HC10-5.0	5.0	30.5	15.6	1.0	5 μ m	●
	HC10-6.0	6.0	30.5	15.6	1.0	5 μ m	●
	HC10-7.0	7.0	30.5	15.6	1.0	5 μ m	●
	HC10-8.0	8.0	30.5	15.6	1.0	5 μ m	●
	HC10-9.0	9.0	30.5	15.6	1.0	5 μ m	●
	HC10-10.0	10.0	30.5	15.6	1.0	5 μ m	●
	HC13	HC13-3.0	3.0	39.0	20.1	1.0	5 μ m
HC13-4.0		4.0	39.0	20.1	1.0	5 μ m	●
HC13-5.0		5.0	39.0	20.1	1.0	5 μ m	●
HC13-6.0		6.0	39.0	20.1	1.0	5 μ m	●
HC13-7.0		7.0	39.0	20.1	1.0	5 μ m	●
HC13-8.0		8.0	39.0	20.1	1.0	5 μ m	●
HC13-9.0		9.0	39.0	20.1	1.0	5 μ m	●
HC13-10.0		10.0	39.0	20.1	1.0	5 μ m	●
HC13-11.0		11.0	39.0	20.1	1.0	5 μ m	●
HC13-12.0		12.0	39.0	20.1	1.0	5 μ m	●
HC13-13.0		13.0	39.0	20.1	1.0	5 μ m	●
HC16		HC16-3.0	3.0	45.0	24.6	1.0	5 μ m
	HC16-4.0	4.0	45.0	24.6	1.0	5 μ m	●
	HC16-5.0	5.0	45.0	24.6	1.0	5 μ m	●
	HC16-6.0	6.0	45.0	24.6	1.0	5 μ m	●
	HC16-7.0	7.0	45.0	24.6	1.0	5 μ m	●
	HC16-8.0	8.0	45.0	24.6	1.0	5 μ m	●
	HC16-9.0	9.0	45.0	24.6	1.0	5 μ m	●
	HC16-10.0	10.0	45.0	24.6	1.0	5 μ m	●
	HC16-11.0	11.0	45.0	24.6	1.0	5 μ m	●
	HC16-12.0	12.0	45.0	24.6	1.0	5 μ m	●
	HC16-13.0	13.0	45.0	24.6	1.0	5 μ m	●
	HC16-14.0	14.0	45.0	24.6	1.0	5 μ m	●
	HC16-15.0	15.0	45.0	24.6	1.0	5 μ m	●
	HC16-16.0	16.0	45.0	24.6	1.0	5 μ m	●

(Unit : mm)

	Designation	ØD	L	ØD1	Clearance	Accuracy	Stock	
HC20	HC20-4.0	4.0	54.3	29.2	2.0	5 μ m	●	
	HC20-6.0	6.0	54.3	29.2	2.0	5 μ m	●	
	HC20-8.0	8.0	54.3	29.2	2.0	5 μ m	●	
	HC20-10.0	10.0	54.3	29.2	2.0	5 μ m	●	
	HC20-12.0	12.0	54.3	29.2	2.0	5 μ m	●	
	HC20-14.0	14.0	54.3	29.2	2.0	5 μ m	●	
	HC20-16.0	16.0	54.3	29.2	2.0	5 μ m	●	
	HC20-18.0	18.0	54.3	29.2	2.0	5 μ m	●	
	HC20-20.0	20.0	54.3	29.2	2.0	5 μ m	●	
	HC25	HC25-16.0	16.0	57.0	35.7	1.0	5 μ m	●
HC25-17.0		17.0	57.0	35.7	1.0	5 μ m	●	
HC25-18.0		18.0	57.0	35.7	1.0	5 μ m	●	
HC25-19.0		19.0	57.0	35.7	1.0	5 μ m	●	
HC25-20.0		20.0	57.0	35.7	1.0	5 μ m	●	
HC25-21.0		21.0	57.0	35.7	1.0	5 μ m	●	
HC25-22.0		22.0	57.0	35.7	1.0	5 μ m	●	
HC25-23.0		23.0	57.0	35.7	1.0	5 μ m	●	
HC25-24.0		24.0	57.0	35.7	1.0	5 μ m	●	
HC25-25.0		25.0	57.0	35.7	1.0	5 μ m	●	

(Unit : mm)

Order example • General type – Order as HC16-8.0 • High precision type – Order as HC16-8.0P

※ Please contact us for items not in the catalog.



HC COLLET

HC Slim collet (precision type)

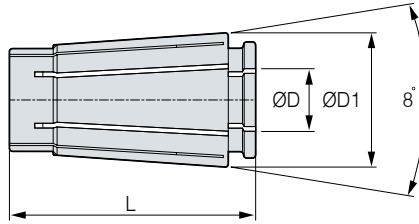
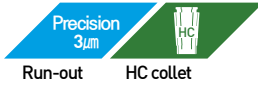

● : Stock

● : To be discontinued

	Designation	ØD	L	ØD1	Clearance	Accuracy	Stock
HC6(P)	HC6-3.0P	3.0	25.0	10.5	1.0	3µm	●
	HC6-4.0P	4.0	25.0	10.5	1.0	3µm	●
	HC6-5.0P	5.0	25.0	10.5	1.0	3µm	●
	HC6-6.0P	6.0	25.0	10.5	1.0	3µm	●
	HC10(P)	HC10-2.0P	2.0	30.5	15.6	1.0	3µm
	HC10-3.0P	3.0	30.5	15.6	1.0	3µm	●
	HC10-4.0P	4.0	30.5	15.6	1.0	3µm	●
	HC10-5.0P	5.0	30.5	15.6	1.0	3µm	●
	HC10-6.0P	6.0	30.5	15.6	1.0	3µm	●
	HC10-7.0P	7.0	30.5	15.6	1.0	3µm	●
	HC10-8.0P	8.0	30.5	15.6	1.0	3µm	●
	HC10-9.0P	9.0	30.5	15.6	1.0	3µm	●
	HC10-10.0P	10.0	30.5	15.6	1.0	3µm	●
HC13(P)	HC13-3.0P	3.0	39.0	20.1	1.0	3µm	●
	HC13-4.0P	4.0	39.0	20.1	1.0	3µm	●
	HC13-5.0P	5.0	39.0	20.1	1.0	3µm	●
	HC13-6.0P	6.0	39.0	20.1	1.0	3µm	●
	HC13-7.0P	7.0	39.0	20.1	1.0	3µm	●
	HC13-8.0P	8.0	39.0	20.1	1.0	3µm	●
	HC13-9.0P	9.0	39.0	20.1	1.0	3µm	●
	HC13-10.0P	10.0	39.0	20.1	1.0	3µm	●
	HC13-11.0P	11.0	39.0	20.1	1.0	3µm	●
	HC13-12.0P	12.0	39.0	20.1	1.0	3µm	●
	HC13-13.0P	13.0	39.0	20.1	1.0	3µm	●
	HC16(P)	HC16-3.0P	3.0	45.0	24.6	1.0	3µm
HC16-4.0P		4.0	45.0	24.6	1.0	3µm	●
HC16-5.0P		5.0	45.0	24.6	1.0	3µm	●
HC16-6.0P		6.0	45.0	24.6	1.0	3µm	●
HC16-7.0P		7.0	45.0	24.6	1.0	3µm	●
HC16-8.0P		8.0	45.0	24.6	1.0	3µm	●
HC16-9.0P		9.0	45.0	24.6	1.0	3µm	●
HC16-10.0P		10.0	45.0	24.6	1.0	3µm	●
HC16-11.0P		11.0	45.0	24.6	1.0	3µm	●
HC16-12.0P		12.0	45.0	24.6	1.0	3µm	●
HC16-13.0P		13.0	45.0	24.6	1.0	3µm	●
HC16-14.0P		14.0	45.0	24.6	1.0	3µm	●
HC16-15.0P		15.0	45.0	24.6	1.0	3µm	●
HC16-16.0P		16.0	45.0	24.6	1.0	3µm	●

(Unit : mm)

	Designation	ØD	L	ØD1	Clearance	Accuracy	Stock	
HC20(P)	HC20-4.0P	4.0	54.3	29.2	2.0	3µm	●	
	HC20-6.0P	6.0	54.3	29.2	2.0	3µm	●	
	HC20-8.0P	8.0	54.3	29.2	2.0	3µm	●	
	HC20-10.0P	10.0	54.3	29.2	2.0	3µm	●	
	HC20-12.0P	12.0	54.3	29.2	2.0	3µm	●	
	HC20-14.0P	14.0	54.3	29.2	2.0	3µm	●	
	HC20-16.0P	16.0	54.3	29.2	2.0	3µm	●	
	HC20-18.0P	18.0	54.3	29.2	2.0	3µm	●	
	HC20-20.0P	20.0	54.3	29.2	2.0	3µm	●	
	HC25(P)	HC25-16.0P	16.0	57.0	35.7	1.0	3µm	●
HC25-17.0P		17.0	57.0	35.7	1.0	3µm		
HC25-18.0P		18.0	57.0	35.7	1.0	3µm		
HC25-19.0P		19.0	57.0	35.7	1.0	3µm		
HC25-20.0P		20.0	57.0	35.7	1.0	3µm	●	
HC25-21.0P		21.0	57.0	35.7	1.0	3µm		
HC25-22.0P		22.0	57.0	35.7	1.0	3µm		
HC25-23.0P		23.0	57.0	35.7	1.0	3µm		
HC25-24.0P		24.0	57.0	35.7	1.0	3µm		
HC25-25.0P		25.0	57.0	35.7	1.0	3µm	●	

(Unit : mm)

Order example • General type – Order as HC16-8.0 • High precision type – Order as HC16-8.0P

※ Please contact us for items not in the catalog.

Chuck

Arbor/Modular

Boring tool

Angular head

CBN/PCD

TAUMAX

Other

1:1 CHAT



BT-NPU

Drill chuck

MAS
403-BT

C

Shank Coolant System Drilling

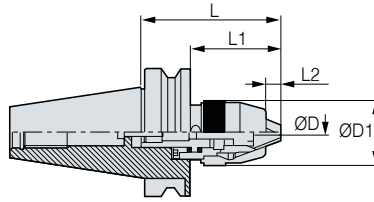

● : Stock

C This product does not support the internal coolant system

• For more information on the related parts, see **121p**.

	Designation	ØD	L	ØD1	L1	L2	Kg	Package weight(Kg)	Stock
BT30	BT30-NPU8-97	1~8	97	38	75	8	0.8	0.9	●
	BT30-NPU13-125	1~13	125	50	103	12	1.4	1.6	●
BT40	BT40-NPU8-87	1~8	87	38	60	8	1.2	1.4	●
	BT40-NPU13-105	1~13	105	50	78	12	1.6	1.9	●
	BT40-NPU13-130	1~13	130	50	103	12	1.9	2.2	●
BT50	BT50-NPU13-130	1~13	130	50	92	12	4.5	4.9	●
	BT50-NPU13-190	1~13	190	50	152	12	5.3	5.7	●

(Unit : mm)

1:1 CHAT



HSK-NPU

Drill chuck

DIN
69893-1

C

Shank Coolant System Drilling

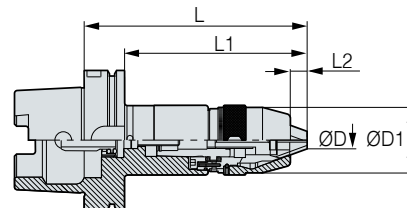

● : Stock

C This product does not support the internal coolant system

• For more information on the related parts, see **121p**.

	Designation	ØD	L	ØD1	L1	L2	Kg	Package weight(Kg)	Stock
HSK63A	HSK63A-NPU13-175	1~13	175	50	149	12	2.4	2.6	●
HSK100A	HSK100A-NPU13-180	1~13	180	50	151	12	3.6	4.0	●

(Unit : mm)



SK-NPU

Drill chuck

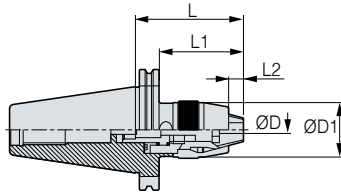

● : Stock

C This product does not support the internal coolant system

• For more information on the related parts, see **121p**

	Designation	ØD	L	ØD1	L1	L2	Kg	Package weight(Kg)	Stock
SK40	SK40-NPU13-105	1~13	105	50	78	12.5	1.6	1.8	●
SK50	SK50-NPU13-111	1~13	111	50	84	12.5	3.6	3.9	●

(Unit : mm)



NPU SPARE PART

Drill chuck related parts

SPARE PART	Type	Main components		Accessories
		Drill chuck head	Bolt	Spanner
	Images			
	Model No.			
	NPU8	NPU08	BX0620	NPU0836
	NPU13	NPU13	BX0825	NPU1348

1:1 CHAT



DTN

Tapping holder



Features

- Fast and convenient tool change
- Using an adapter with a tensile and shrinking device
- Boring range : M3-M38

NAMING

BT40	—	DTN	—	22	—	130
Spindle		Tapping Holder		Tapping Range		Length



Easy TCA (Tap adapter) change

- Fast tap change per adapter pi based on the one-touch change method that enables high accuracy and a long service life and useful for various machining operations
- Enables tension and contraction using the axial direction floating method

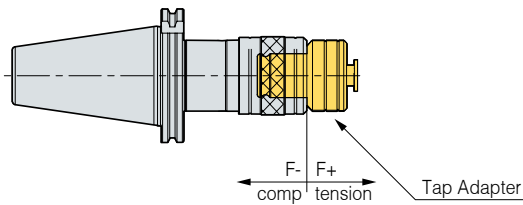

How to tighten

TCA insertion

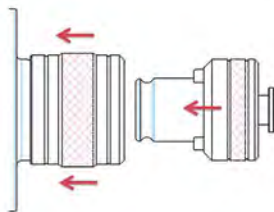

1. Insert TCA after pressing the tap holder cover down
2. Connect TCA to be aligned with the key groove and press it until the sound "click" is heard.

TCA mounting

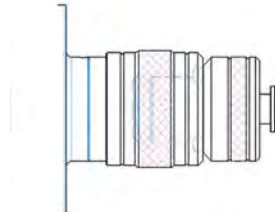

1. The tap holder cover is put in the normal position.

TCA removal

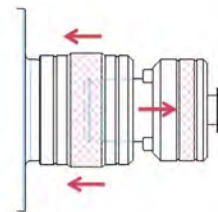

1. Remove TCA after pressing the tap holder cover.

C This product does not support the internal coolant system

※ DTN12, DTN22 : Remove them by pulling the sliding ring down. ※ DTN38 : Remove it by pulling the adapter forward.



BT-DTN

Tapping holder

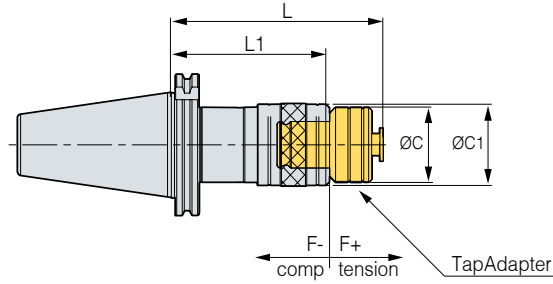

● : Stock

C This product does not support the internal coolant system

• For more information on the product features, see **122p**

• For more information on the applicable adapter, see **125p**

	Designation	Tap size	ØC	L	ØC1	L1	Adapter used	F-	F+	Kg	Package weight(Kg)	Stock	
BT30	BT30-DTN12-85	M3~M12	32	85	39	60	TCA1-M	4	10	0.5	0.7	●	
BT40	BT40-DTN12-90	M3~M12	32	90	39	65	TCA1-M	4	10	1.2	1.4	●	
	BT40-DTN12-120	M3~M12	32	120	39	95	TCA1-M	4	10	1.5	1.7	●	
	BT40-DTN22-130	M8~M24	50	130	56	96	TCA2-M	12.5	12.5	1.7	1.9	●	
	BT40-DTN22-160	M8~M24	50	160	56	126	TCA2-M	12.5	12.5	2.2	2.4	●	
BT50	BT50-DTN12-100	M3~M12	32	100	39	75	TCA1-M	4	10	3.9	4.2	●	
	BT50-DTN12-130	M3~M12	32	130	39	105	TCA1-M	4	10	3.9	4.3	●	
	BT50-DTN22-140	M8~M24	50	140	56	106	TCA2-M	12.5	12.5	4.3	4.7	●	
	BT50-DTN22-170	M8~M24	50	170	56	136	TCA2-M	12.5	12.5	4.7	5.1	●	
	BT50-DTN38-185	M16~M38	72	185	81	140	TCA3-M	20	20	5.7	6.1	●	
	BT50-DTN38-215	M16~M38	72	215	81	170	TCA3-M	20	20	6.7	7.1	●	

(Unit : mm)

Chuck

Arbor/Modular

Boring tool

Angular head

CBN/PCD

TAUMAX

Other

1:1 CHAT



S-DTN

Straight shank tapping holder

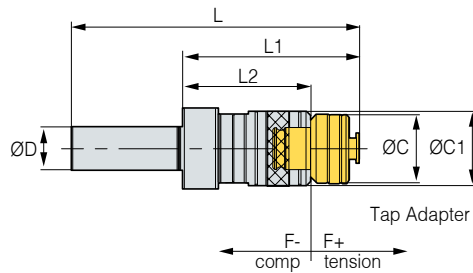

● : Stock

C This product does not support the internal coolant system

• For more information on the product features, see **122p**.

• For more information on the applicable adapter, see **125p**.

Designation	Tapping range	ØC	ØD	L	ØC1	L1	L2	Adapter used	F-	F+	Kg	Package weight(Kg)	Stock
S32 S32-DTN12-90	M3-M12	32	32	170	39	90	65	TCA1	4	10	1.0	1.1	●
S32-DTN22-130	M8-M24	50	32	210	56	130	96	TCA2	12.5	12.5	1.8	1.9	●

(Unit : mm)

1:1 CHAT



SK-DTN

Tapping holder

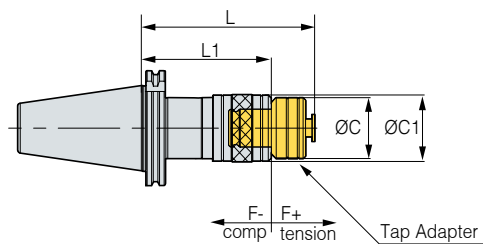

● : Stock

C This product does not support the internal coolant system

• For more information on the product features, see **122p**.

• For more information on the applicable adapter, see **125p**.

Designation	Tap size	ØC	L	ØC1	L1	Adapter used	F-	F+	Kg	Package weight(Kg)	Stock
SK40 SK40-DTN12-90	M3-M12	32	90	39	65	TCA1-M	4	10	1.0	1.2	●
SK40-DTN22-130	M8-M24	50	130	56	96	TCA2-M	12.5	12.5	1.6	1.8	●
SK50 SK50-DTN12-100	M3-M12	32	100	39	75	TCA1-M	4	10	2.9	3.2	●
SK50-DTN22-140	M8-M24	50	140	56	106	TCA2-M	12.5	12.5	3.5	3.9	●

(Unit : mm)



TCA

Tap adapter

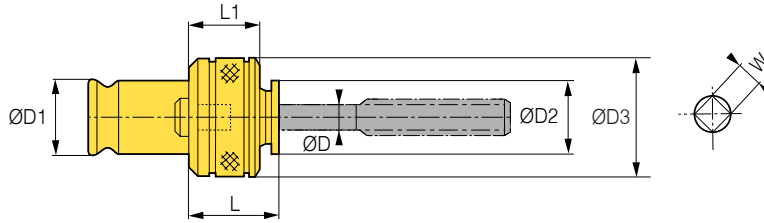

● : Stock

C This product does not support the internal coolant system

※ DIN standards can be made to order

• For more information on the product features, see **122p**

	Designation	ØD	L	ØD1	L1	ØD2	ØD3	W	Kg	Package weight(Kg)	Stock
TCA1	TCA1-M3	4	27	19	25	19	32	3	0.2	0.2	●
	TCA1-M4	5	27	19	25	19	32	4	0.2	0.2	●
	TCA1-M5	6	27	19	25	19	32	4	0.2	0.2	●
	TCA1-M6	6	27	19	25	19	32	4	0.2	0.2	●
	TCA1-M8	6.2	27	19	25	19	32	5	0.2	0.2	●
	TCA1-M10	7	27	19	25	19	32	6	0.2	0.2	●
	TCA1-M11	8	27	19	25	19	32	6	0.2	0.2	●
	TCA1-M12	9	27	19	25	19	32	7	0.2	0.2	●
TCA2	TCA2-M8	6.2	34	31	31	29	50	5	0.5	0.5	●
	TCA2-M10	7	34	31	31	29	50	6	0.5	0.5	●
	TCA2-M12	8.5	34	31	31	29	50	7	0.5	0.5	●
	TCA2-M14	11	34	31	31	29	50	8	0.5	0.5	●
	TCA2-P1/4	11	34	31	31	29	50	9	0.5	0.5	●
	TCA2-M16	13	34	31	31	29	50	10	0.5	0.5	●
	TCA2-M18	14	34	31	31	29	50	11	0.5	0.5	●
	TCA2-M20	15	34	31	31	29	50	12	0.5	0.5	●
	TCA2-M22	17	34	31	31	29	50	13	0.5	0.5	●
	TCA2-P1/2	18	34	31	31	29	50	14	0.5	0.5	●
	TCA2-M24	19	34	31	31	29	50	15	0.5	0.5	●
	TCA3	TCA3-M16	13	45	48	41	44	72	10	1.4	1.6
TCA3-M18		14	45	48	41	44	72	11	1.4	1.6	●
TCA3-M20		15	45	48	41	44	72	12	1.4	1.6	●
TCA3-M22		17	45	48	41	44	72	13	1.4	1.6	●
TCA3-M24		19	45	48	41	44	72	15	1.4	1.6	●
TCA3-M27		20	45	48	41	44	72	15	1.4	1.6	●
TCA3-M30		23	45	48	41	44	72	17	1.4	1.6	●
TCA3-M33		25	45	48	41	44	72	19	1.4	1.6	●
TCA3-M36		28	45	48	41	44	72	21	1.4	1.6	●

(Unit : mm)

Chuck

Arbor/Modular

Boring tool

Angular head

cBN/PCD

TAUMAX

Other

1:1 CHAT



DST PAT.

High speed synchro tapping chuck



Features

- Tapping chuck for high speed machining
- Specially designed to absorb thrust load to provide tap damage prevention and a longer tool service life
- Internal coolant applicable
- Boring range : M1 ~ M22

NAMING	BT40	DST	22	110
	Spindle	Tapping Holder	Tapping Range	Length



Precise machining

Machining range expanded

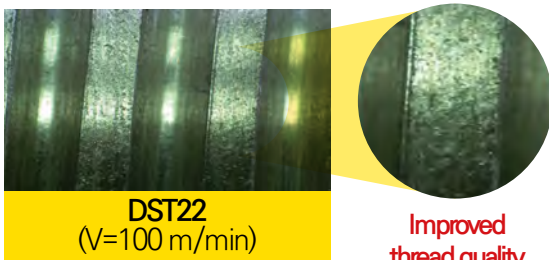

M1.4x0.3 service life test

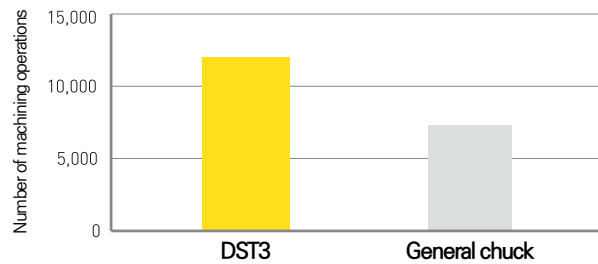

Increased tool service life versus collet chuck use

Tapping dedicated collet

- In the case of tapping, it is recommended to use TER collet.
- DST3 : ER11 collet used



Comparison of Thread shape

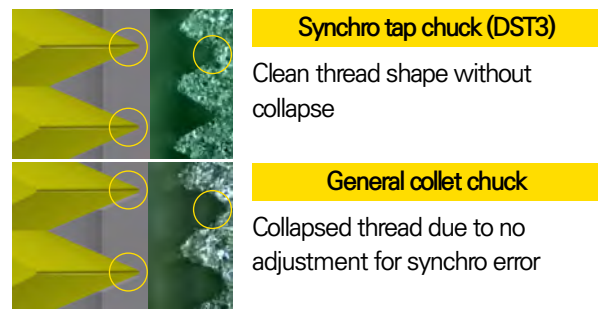
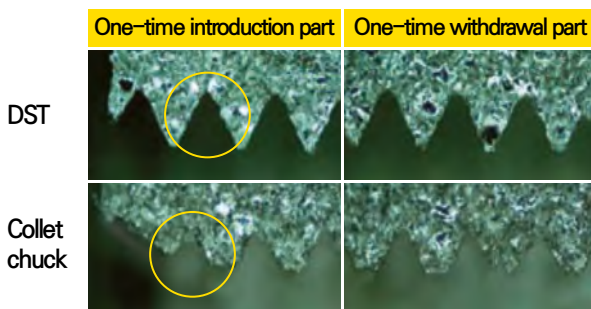

C Internal coolant system is optional



BT-DST

High speed synchro tapping chuck

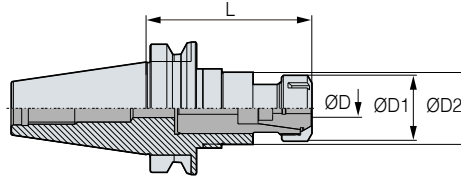

● : Stock

C Internal coolant system is optional

- For more information on the product features, see **126p**
- For more information on ER collet, see **100p**
- For more information on TER collet, see **129p**
- For more information on Internal coolant system, see **128p**

	Designation	ØD	L	ØD1	ØD2	Collet used	F-	F+	Kg	Package weight(Kg)	Stock
BT30	BT30-DST3-70	M1~M3	70	20	19	ER11	0.5	0.5	0.5	0.5	●
	BT30-DST10-100	M3~M10	100	40.4	28	TER16	0.5	0.5	0.8	0.9	●
BT40	BT40-DST3-70	M1~M3	70	20	19	ER11	0.5	0.5	1.0	1.1	●
	BT40-DST10-100	M3~M10	100	40.4	28	TER16	0.5	0.5	1.3	1.4	●
	BT40-DST22-110	M6~M22	110	60	50	TER32	0.7	0.7	1.7	2.0	●
BT50	BT50-DST10-110	M3~M10	110	60	50	TER16	0.5	0.5	3.8	4.1	●
	BT50-DST22-130	M6~M22	130	60	50	TER32	0.7	0.7	4.5	4.9	●

(Unit : mm)



HSK-DST

High speed synchro tapping chuck

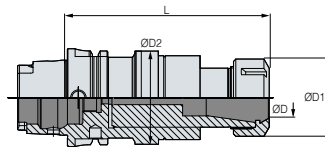

● : To be discontinued

● : Stock

C Internal coolant system is optional

- For more information on the product features, see **126p**
- For more information on ER collet, see **100p**
- For more information on TER collet, see **129p**
- For more information on Internal coolant system, see **128p**

	Designation	ØD	L	ØD1	ØD2	Collet used	F-	F+	Kg	Package weight(Kg)	Stock
HSK63A	HSK63A-DST3-80	M1~M3	80	19	20	ER11	0.5	0.5	0.7	0.8	●
	HSK63A-DST10-100	M3~M10	100	28	40.4	TER16	0.5	0.5	0.9	1.2	●
	HSK63A-DST22-130	M6~M22	130	50	60	TER32	0.7	0.7	1.8	2.0	●

(Unit : mm)

Chuck

Arbor/Modular

Boring tool

Angular head

CBN/PCD

TAUMAX

Other

1:1 CHAT



SK-DST

High speed synchro tapping chuck

DIN69871
-1A/B

G6.3

C



Shank

G value

Coolant System

Tapping

TER collet

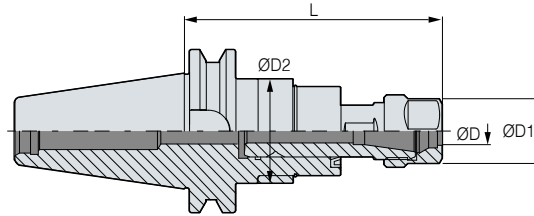

- : To be discontinued
- : Stock

C Internal coolant system is optional

- For more information on the product features, see [126p](#).
- For more information on ER collet, see [100p](#).
- For more information on TER collet, see [129p](#).
- For more information on Internal coolant system, see [128p](#).

	Designation	ØD	L	ØD1	ØD2	Collet used	F-	F+	Kg	Package weight(Kg)	Stock
SK30	SK30-DST3-70	M1~M3	70	19	20	ER11	0.2	0.2	0.4	0.5	●
SK40	SK40-DST3-70	M1~M3	70	19	20	ER11	0.2	0.2	0.9	1.0	●
	SK40-DST10-110	M3~M10	110	28	35	TER16	0.5	0.5	1.2	1.4	●
	SK40-DST22-120	M6~M22	120	50	54	TER32	0.7	0.7	1.8	2.1	●
SK50	SK50-DST10-110	M3~M10	110	28	35	TER16	0.5	0.5	3.0	3.3	●
	SK50-DST22-120	M6~M22	120	50	54	TER32	0.7	0.7	3.7	4.1	●

(Unit : mm)

1:1 CHAT



DST SPARE PART

High speed synchro tapping chuck related parts

SPARE PART	Type	Main components		Accessories			Type	Accessories		
		Nut		Spanner		ER/TER		Coolant tube for HSK		
	Images								Images	
	Model No.								Model No.	
	DST3	R11		S-17		GERC11/ER11-ØD			HSK50A	HSK50A-CNS
	DST10	R16		S-25			TER16-ØD		HSK63A	HSK63A-CNS
	DST22		RU32		48-52		TER32-ØD		HSK100A	HSK100A-CNS



TER

TER Collet

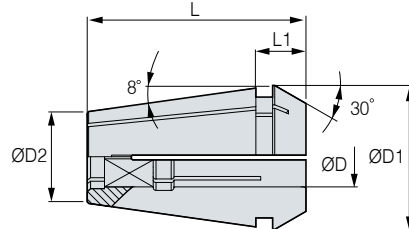
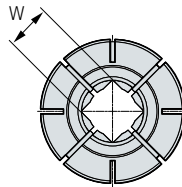

● : Stock

※ Waterproof type tapping is possible by using RTJW and RUT nuts (standard dimension only)

	Designation	Tap applied	ØD	L	W	ØD1	ØD2	L1	Kg	Package weight(Kg)	Stock
TER16	TER16-4x3.2	M3	4	27.5	3.2	16.74	10.1	6.3	0.03	0.03	●
	TER16-5x4	M4	5	27.5	4	16.74	10.1	6.3	0.03	0.03	●
	TER16-5.5x4.5	M5	5.5	27.5	4.5	16.74	10.1	6.3	0.02	0.02	●
	TER16-6x4.5	M6,U1/4	6	27.5	4.5	16.74	10.1	6.3	0.02	0.02	●
	TER16-6.2x5	M7, M8	6.2	27.5	5	16.74	10.1	6.3	0.02	0.02	●
	TER16-7x5.5	M9, M10, U3/8	7	27.5	5.5	16.74	10.1	6.3	0.02	0.02	●
TER20	TER20-5x4	M4	5	31.5	4	20.74	13.2	7.2	0.05	0.05	●
	TER20-5.5x4.5	M5	5.5	31.5	4.5	20.74	13.2	7.2	0.05	0.05	●
	TER20-6x4.5	M6,U1/4	6	31.5	4.5	20.74	13.2	7.2	0.05	0.05	●
	TER20-6.2x5	M7, M8	6.2	31.5	5	20.74	13.2	7.2	0.04	0.04	●
	TER20-7x5.5	M9, M10, U3/8	7	31.5	5.5	20.74	13.2	7.2	0.05	0.05	●
	TER20-8x6	M11, U7/16, P1/8	8	31.5	6	20.74	13.2	7.2	0.04	0.04	●
	TER20-8.5x6.5	M12	8.5	31.5	6.5	20.74	13.2	7.2	0.04	0.04	●
TER25	TER25-5x4	M4	5	34	4	25.74	17.6	7.5	0.9	0.9	●
	TER25-5.5x4.5	M5	5.5	34	4.5	25.74	17.6	7.5	0.8	0.8	●
	TER25-6x4.5	M6	6	34	4.5	25.74	17.6	7.5	0.8	0.8	●
	TER25-6.2x5	M7, M8	6.2	34	5	25.74	17.6	7.5	0.1	0.1	●
	TER25-7x5.5	M9, M10, U3/8	7	34	5.5	25.74	17.6	7.5	0.8	0.8	●
	TER25-8.5x6.5	M12	8.5	34	6.5	25.74	17.6	7.5	0.8	0.8	●
TER32	TER32-6x4.5	M6,U1/4	6.2	40	4.5	32.74	23.1	8.2	0.2	0.2	●
	TER32-6.2x5	M7, M8	6.2	40	5	32.74	23.1	8.2	0.2	0.2	●
	TER32-7x5.5	M9, M10, U3/8	7	40	5.5	32.74	23.1	8.2	0.2	0.2	●
	TER32-8x6	M11, U7/16, P1/8	8	40	6	32.74	23.1	8.2	0.2	0.2	●
	TER32-8.5x6.5	M12	8.5	40	6.5	32.74	23.1	8.2	0.2	0.2	●
	TER32-10.5x8	M14, U9/16	10.5	40	8	32.74	23.1	8.2	0.2	0.2	●
	TER32-12.5x10	M16	12.5	40	10	32.74	23.1	8.2	0.2	0.2	●
	TER32-9x7	U1/2	9	40	7	32.74	23.1	8.2	0.2	0.2	●
	TER32-11x9	P1/4	11	40	9	32.74	23.1	8.2	0.2	0.2	●
	TER32-12x9	U5/8	12	40	9	32.74	23.1	8.2	0.2	0.2	●
	TER32-14x11	M18, P3/8	14	40	11	32.74	23.1	8.2	0.1	0.1	●
	TER32-15x12	M20	15	40	12	32.74	23.1	8.2	0.1	0.1	●
	TER32-17x13	M22, U7/8	17	40	13	32.74	23.1	8.2	0.1	0.1	●

(Unit : mm)

Chuck

Arbor/Modular

Boring tool

Angular head

CBN/PCD

TAUMAX

Other

1:1 CHAT



TEH

NEW

Tap Extension Holder

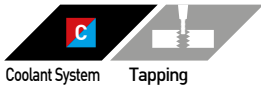

Features

- Product specialized for processing deep, narrow hole taps
- Excellent rigidity and stable runout thanks to a short incision unit
- Excellent economic efficiency in comparison with the general long tap
- Prevention of over clamping thanks to applied O-ring
- Optimized for processing narrow, deep holes such as the hole of an engine

NAMING

TEH	230	D6	J	M6	C
Tap Extension Holder	Length	Shank dia.	J: JIS NON: DIN	Tap size	C: Coolant NON: General



Structure

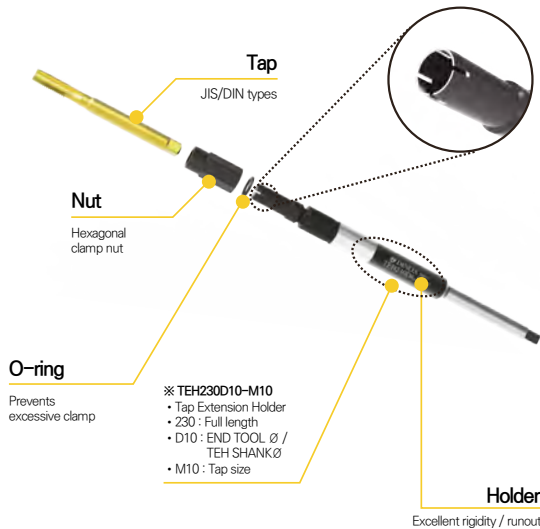

Processing of Deep Holes

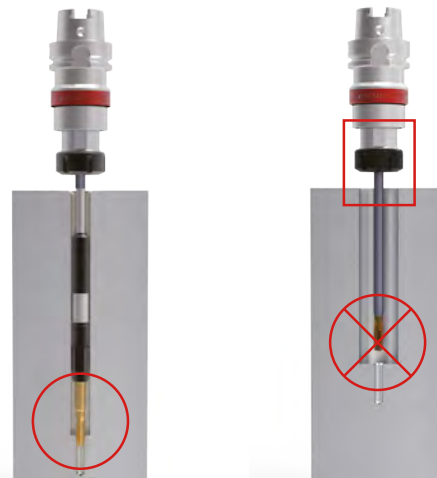

TEH

General long tap

Processing ○

No processing X

Full length comparison	General long tap	TEH
M10	150mm	230mm
M22	200mm	330mm

※ Since the full length is longer than that of the general long tap, it is favorable for processing narrow, deep holes.

TEH Setting Method



DST
High speed synchro tapping chuck

TER Collet

TEH
Tap Extension Holder

Tap
(M4~M22)



TEH (SPEC/JIS)

NEW

Tap Extension Holder

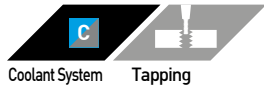

Fig.1

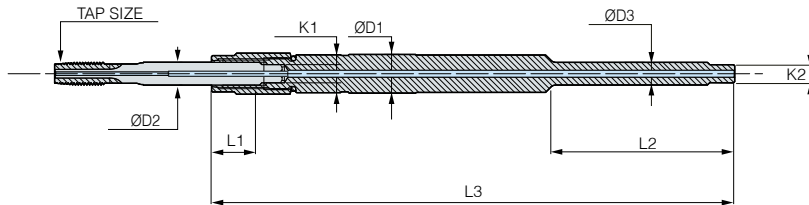
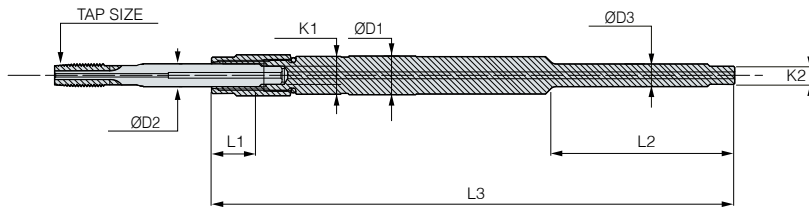

Fig.2



c Internal coolant system is basic

c Fig.2 does not support the internal coolant system

• For more information on the product features, see **130p**.

	Designation (JIS Specifications)	Tap size	L1	L2	L3	ØD1	ØD2	ØD3	K1	K2	Nut external diameter Ø	Fig.	Stock
TEH230	TEH230D5J-M4	M4	23	50	230	11	5	6	5	5	12.7	2	
	TEH230D6J-M6C	M6	23	50	230	12	6	6	5	5	13.9	1	
	TEH230D6.2J-M8C	M8	24	65	230	12	6.2	6.2	5	5	13.9	1	
	TEH230D7J-M10C	M10	24	65	230	13	7	7	6	6	15	1	
	TEH230D8.5J-M12C	M12	28	65	230	14	9	9	7	7	16	1	
TEH330	TEH330D10.5J-M14C	M14	33	70	330	16	11	11	8	8	18	1	
	TEH330D12.5J-M16C	M16	34	70	330	18	13	13	10	10	20	1	
	TEH330D14J-M18C	M18	35	70	330	20	14	14	11	11	22	1	
	TEH330D15J-M20C	M20	36	75	330	21	15	15	12	12	23	1	
	TEH330D17J-M22C	M22	36	75	330	23	17	17	13	13	26	1	

(Unit : mm)



STER PAT. NEW

DINE Synchro Tapping ER Collet



Features

It is special ER collet that can minimize synchronizing error with general ER collet chuck

- Minimize synchronization error, improve thread precision
- Prevention of TAP damage and extension of tool life
- Improved thread tolerance
- For high-speed machining, use of a dedicated tap is recommended
- Optimized design in MCT with RIGID function

NAMING

ST	ER	16	3
Synchronizing Tapping Collet	Collet	Collet size	Tool dia.

Details

STER32

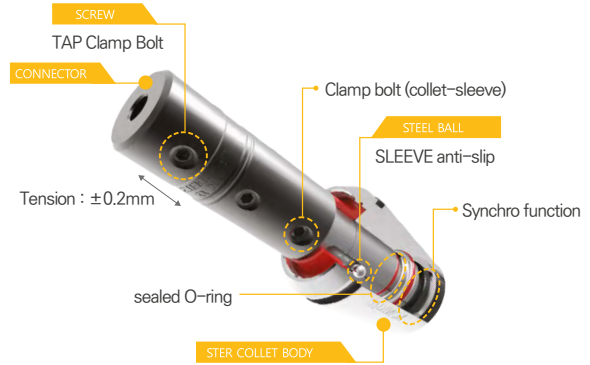

Detailed specification

COLLET

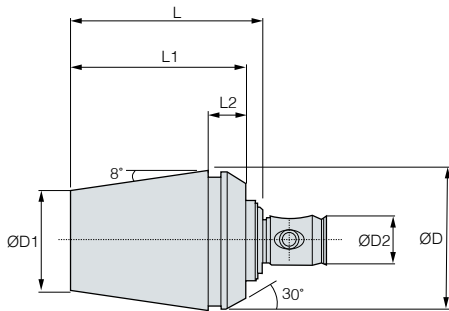

※ COLLET

- ● : Stock

Designation	ØD	ØD1	ØD2	ØD3	L	L1	L2	Fig.	Stock
STER32	32	23.1	11	11	44	40	8.2	1	●

(Unit : mm)

※ CONNECTOR

- ● : Stock

Designation	ØD	ØD1	ØD2	ØD3	L	H	W	Fig.	Stock
STER32C-M6	19	21	6	11	50	29.5	4.5	2	●
STER32C-M8	19	21	6.2	11	50	30	5	2	●
STER32C-M10	19	21	7	11	50	29	5.5	2	●
STER32C-M12	19	21	8.5	11	50	30.5	6.5	2	●
STER32C-M14	19	21	10.5	11	50	31	8	2	●
STER32C-M16	19	21	12.5	11	50	40.5	10	2	●

(Unit : mm)

CONNECTOR

Fig.1

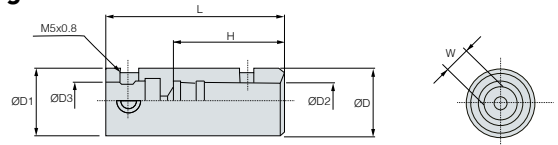
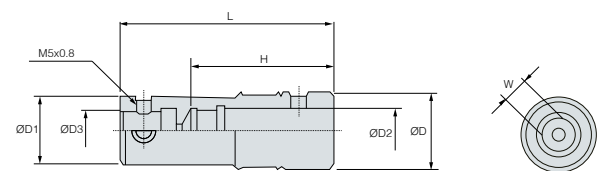

Fig.2



PART[Screw]

BTT0506F



BT0504



PART[Screw]

LW-2.5



Chuck

Arbor/Modular

Boring tool

Angular head

CBN/PCD

TAUMAX

Other

1:1 CHAT



OFH

Floating holder for brush



G6.3	15,000	2~8N	C	
G value	Max RPM	Load	Coolant System	Deburring

Features

- Can be used consistently as a dedicated arbor (floating function) with steady pressure
- G6.3 , Max RPM 15,000rpm
- Provides a longer brush service life (about 50% increase versus collet chuck)
- Reduces lead time and improves productivity
- Various sizes of sleeves and brushes can be used

NAMING	BT30	OFH	6	75
	Spindle	Floating Holder for Brush	Brush Dia.	Length



Integral exclusive tool



Comparison of brush wear performance

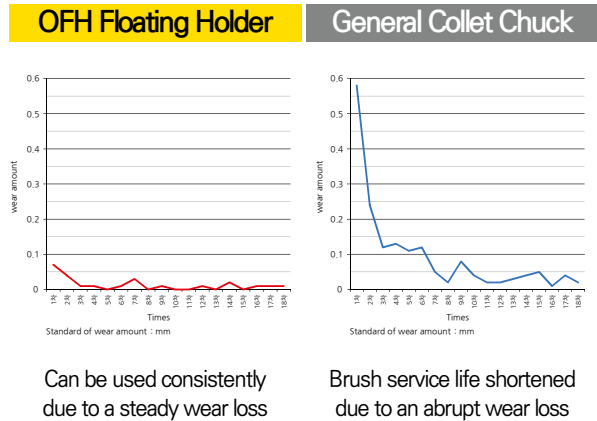

Deburring after cutting aluminium

Pocket

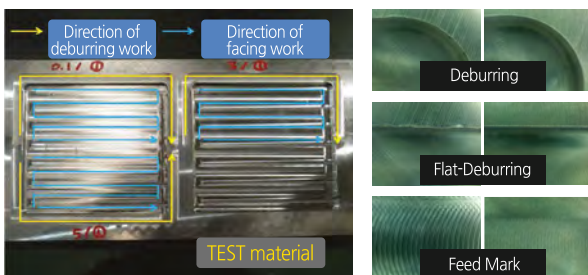

Surface roughness improved about 4 times
 0.906 μ m (before application) \rightarrow 0.179 μ m (after application)

Boss

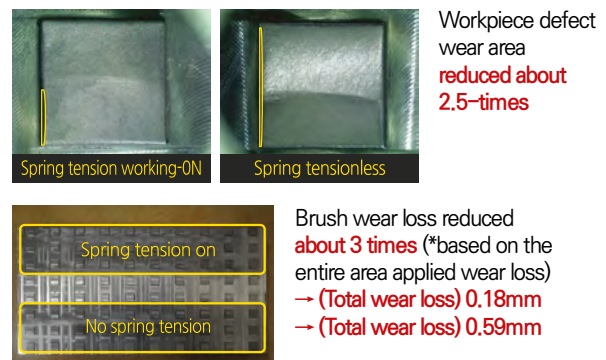



BT-OFH

Floating holder for brush



MAS 403-BT G6.3 15,000 6mm C

Shank G value Max RPM Sleeve Coolant System Deburring

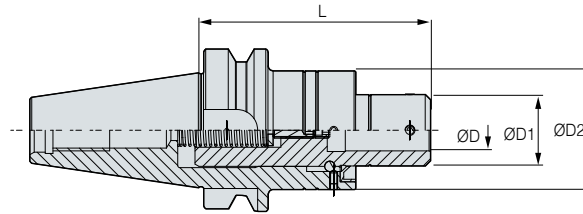

● : Stock

C This product does not support the internal coolant system

• For more information on the product features, see **134p**.

Designation	Sleeve Dia. (ØD)	L	ØD1	ØD2	ØD3	Sleeve stroke(F)	RPM	Stock
BT30 BT30-OFH6-75	6	75	19.7	38	6	6	15,000	●

(Unit : mm)



ST-OFH

Floating holder for brush



G6.3 15,000 6mm C

G value Max RPM Sleeve Coolant System Deburring

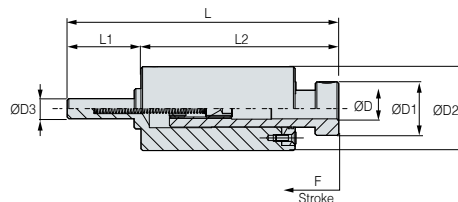

● : Stock

C This product does not support the internal coolant system

• For more information on the product features, see **134p**.

Designation	Sleeve Dia. (ØD)	L	ØD1	ØD2	ØD3	L1	L2	Sleeve stroke(F)	RPM	Stock
ST06 ST06-OFH6-60	6	81	16	25	6	59	22	6	15,000	●

(Unit : mm)

Chuck

Arbor/Modular

Boring tool

Angular head

CBN/PCD

TAUMAX

Other



Arbor/ Modular

DINOX NC TOTAL TOOLING SYSTEM

SLA	138
MTA	142
FMA	143
FMC	146
MD	150
EXT	156
RDC	156



BT-SLA

Side lock arbor

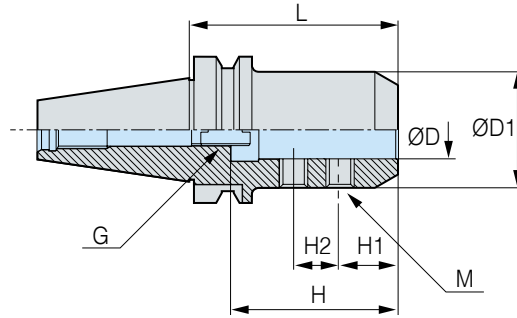

● : Stock

C Internal coolant system is basic

• For more information on the related parts, see **141p**.

	Designation	ØD	L	ØD1	H	H1	H2	M	G	Kg	Package weight(Kg)	Stock
BT30	BT30-SLA16-90	16	90	40	72	25	20	M10	M12	0.9	1.0	●
	BT30-SLA20-90	20	90	50	72	25	20	M12	M12	1.2	1.3	●
	BT30-SLA25-90	25	90	50	72	25	20	M12	M12	1.1	1.2	●
BT40	BT40-SLA16-90	16	90	40	72	25	20	M10	M12	1.4	1.6	●
	BT40-SLA20-90	20	90	50	72	25	20	M12	M12	1.8	2.0	●
	BT40-SLA25-90	25	90	50	72	25	20	M12	M12	1.6	1.8	●
	BT40-SLA32-90	32	90	60	82	25	25	M14	M12	1.8	2.0	●
	BT40-SLA32-105	32	105	60	82	25	25	M14	M12	2.0	2.3	●
	BT40-SLA40-105	40	105	80	82	25	25	M16	M12	2.9	3.1	●
BT50	BT50-SLA16-90	16	90	40	72	25	20	M10	M12	4	4.3	
	BT50-SLA20-105	20	105	50	72	25	20	M12	M12	4.4	4.7	●
	BT50-SLA25-105	25	105	50	72	25	20	M12	M12	4.3	4.6	●
	BT50-SLA25-135	25	135	50	72	25	20	M12	M12	4.6	4.9	
	BT50-SLA25-165	25	165	50	72	25	20	M12	M12	5.2	5.5	
	BT50-SLA32-105	32	105	60	82	25	25	M14	M12	4.5	4.8	●
	BT50-SLA32-135	32	135	60	82	25	25	M14	M12	5.1	5.4	
	BT50-SLA32-165	32	165	60	82	25	25	M14	M12	5.7	6.1	
	BT50-SLA40-105	40	105	90	82	25	25	M16	M12	6.1	6.4	●
	BT50-SLA40-150	40	150	90	82	25	25	M16	M12	8.1	8.5	
	BT50-SLA42-105	42	105	90	82	25	25	M16	M12	5.9	6.2	●

(Unit : mm)



HSK-SLA

Side lock arbor

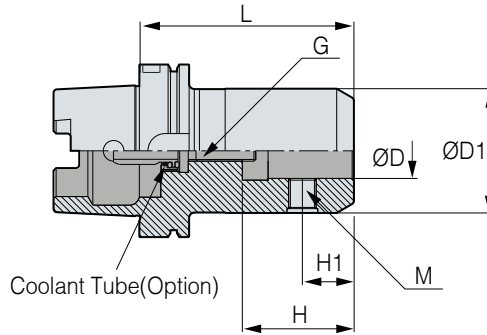

● : Stock

C Internal coolant system is optional

• For more information on the related parts, see **141p**

	Designation	ØD	L	ØD1	H	H1	M	G	Kg	Package weight(Kg)	Stock
HSK63A	HSK63A-SLA20-100	20	100	52	51	25	M8	M12	1.6	1.8	●
	HSK63A-SLA25-105	25	105	65	59	25	M8	M12	2.1	2.4	●
	HSK63A-SLA32-105	32	105	72	63	30	M5	M12	2.3	2.6	●
HSK100A	HSK100A-SLA20-105	20	105	52	51	25	M16	M12	3.1	3.4	●
	HSK100A-SLA25-110	25	110	65	59	25	M18	M12	3.8	4.0	●
	HSK100A-SLA32-125	32	125	72	63	30	M20	M12	4.4	4.8	●
	HSK100A-SLA40-135	40	135	80	73	32	M20	M12	5.2	5.6	

(Unit : mm)

Accessories

SPARE PART	Type	Accessories
	Images	
	Model No.	
	HSK63A	HSK63A-CNS
	HSK100A	HSK100A-CNS





SLA SPARE PART

Side lock arbor related parts





Main components

SPARE PART	Type	Main components	
		Set screw	Adjust screw
	Images		
Model No.	BT type	HSK / SK type	
SLA16	BTF1010	BTF 1414 - 1.5	M1230C
SLA20	BTF1212-1.5	BTF1616 - 1.5	M1230C
SLA25	BTF1212-1.5	BTF1818 - 1.5	M1230C
SLA32	BTF1414-1.5	BTF2020 - 1.5	M1230C
SLA40	BTF1616-1.5	BTF2020 - 1.5	M1230C
SLA42	BTF1624-1.5	BTF2020 - 1.5	M1230C

※ In the case of HSK types, adjustment screws may be different.

Accessories

SPARE PART	Type	Accessories		Type	Accessories
		Wrench			Coolant tube for HSK
	Images		Images		
Model No.	BT type	HSK / SK type	Model No.		
SLA16	LW - 5	LW - 6	HSK63A	HSK63A-CNS	
SLA20	LW - 6	LW - 8	HSK100A	HSK100A-CNS	
SLA25	LW - 6	LW - 8			
SLA32	LW - 6	LW - 10			
SLA40	LW - 8	LW - 10			
SLA42	LW - 8	LW - 10			

Chuck

Arbor/Modular

Boring tool

Angular head

CBN/PCD

TAUMAX

Other



BT-FMA

Face mill arbor



Fig.1

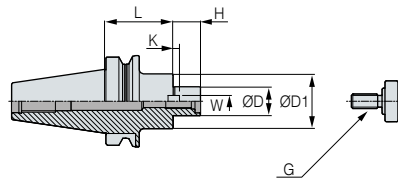

Fig.2

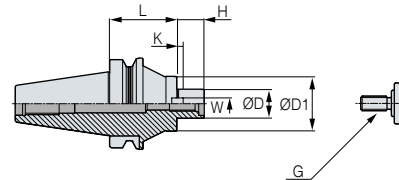

Fig.3

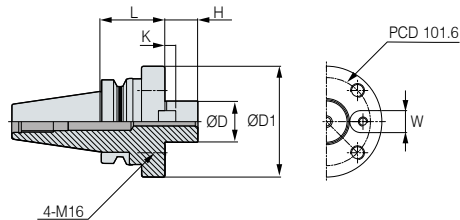
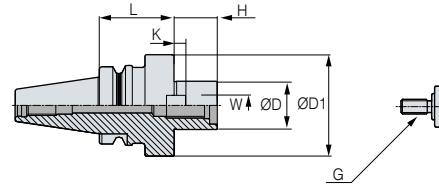

Fig.4



● : Stock

C Internal coolant system is optional

※ The relevant weight excludes the weight of the face cutter

• For more information on the related parts, see **145p**

	Designation	Cutter diameter	ØD	L	ØD1	H	W	K	G	Fig.	Kg	Package weight(Kg)	Stock
BT30	BT30-FMA25.4-45	80	23.4	45	50	22	9.5	5	M12	4	1.0	1.0	●
BT40	BT40-FMA25.4-45	80	25.4	45	50	22	9.5	5	M12	1	1.4	1.6	●
	BT40-FMA25.4-90	80	25.4	90	50	22	9.5	5	M12	1	2.2	2.4	●
	BT40-FMA31.75-45	100	31.75	45	60	30	12.7	7	M16	1	1.6	1.8	●
	BT40-FMA31.75-75	100	31.75	75	60	30	12.7	7	M16	1	2.2	2.4	
	BT40-FMA31.75-90	100	31.75	90	60	30	12.7	7	M16	1	2.5	2.7	●
	BT40-FMA38.1-60	125	38.1	60	80	34	15.87	9	M20	4	2.6	2.8	●
BT50	BT50-FMA25.4-45	80	25.4	45	50	22	9.5	5	M12	1	4.0	4.3	●
	BT50-FMA25.4-90	80	25.4	90	50	22	9.5	5	M12	1	4.7	5.0	●
	BT50-FMA25.4-150	80	25.4	150	50	22	9.5	5	M12	2	6.4	6.8	●
	BT50-FMA31.75-45	100	31.75	45	60	30	12.7	7	M16	1	4.1	4.4	●
	BT50-FMA31.75-75	100	31.75	75	60	30	12.7	7	M16	1	4.8	5.1	●
	BT50-FMA31.75-105	100	31.75	105	60	30	12.7	7	M16	2	5.6	5.9	●
	BT50-FMA38.1-45	125	38.1	45	80	34	15.87	9	M20	1	4.4	4.7	●
	BT50-FMA38.1-75	125	38.1	75	80	34	15.87	9	M20	1	5.6	5.9	●
	BT50-FMA50.8-45	160	50.8	45	100	36	19.05	10	M24	1	4.9	5.2	●
	BT50-FMA50.8-75	160	50.8	75	100	36	19.05	10	M24	1	6.8	7.1	●
	BT50-FMA47.625-75	200	47.625	75	128	38	25.4	12.5	-	3	8.3	8.6	●

(Unit : mm)

Chuck

Arbor/Modular

Boring tool

Angular head

CBN/PCD

TAUMAX

Other



FMA SPARE PART

Face mill arbor related parts



Chuck

Arbor/Modular

Boring tool





Angular head

CBN/PCD

TAUMAX

Other

Main components

SPARE PART	Type	Main components			
		Key	Key bolt	Mount bolt	Clamp bolt
	Images				
	Model No.				
	FMA25.4	K9.5	BX0412	MBA-M12	BX1230
	FMA31.75	K12.7	BX0515	MBA-M16	-
	FMA38.1	K15.87	BX0616	MBA-M20	-
	FMA50.8	K19.05	BX0820	MBA-M24	-
	FMA47.625	K25.4	BX1020	-	BX1645

Accessories

SPARE PART	Type	Accessories
		Wrench
	Images	
	Model No.	
	FMA25.4	LW-10
	FMA31.75	LW-14
	FMA38.1	LW-17



BT-FMC

Face mill arbor



Fig.1

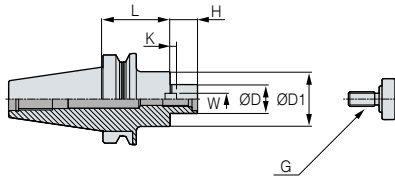

Fig.2

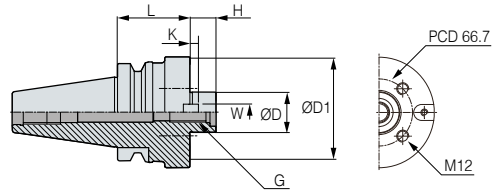
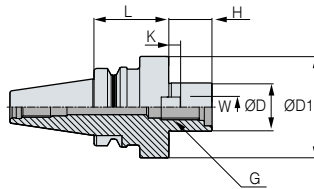

Fig.3



● : Stock

C Internal coolant system is optional

※ The relevant weight excludes the weight of the face cutter

• For more information on the related parts, see **149p**.

	Designation	Cutter diameter	ØD	L	ØD1	H	W	K	G	Fig.	Kg	Package weight(Kg)	Stock
BT30	BT30-FMC16-45	40	16	45	38	17	8	5.0	M8	1	0.7	0.7	●
	BT30-FMC22-45	50/63	22	45	48	19	10	5.6	M10	2	0.8	0.9	●
	BT30-FMC27-50	80	27	50	60	21	12	6.3	M12	2	1.0	1.1	●
BT40	BT40-FMC16-60	40	16	60	38	17	8	5.0	M8	1	1.3	1.5	●
	BT40-FMC22-45	50/63	22	45	48	19	10	5.6	M10	1	1.3	1.5	●
	BT40-FMC22-90	50/63	22	90	48	19	10	5.6	M10	1	1.9	2.1	●
	BT40-FMC27-60	80	27	60	60	21	12	6.3	M12	1	1.8	2.0	●
	BT40-FMC27-90	80	27	90	60	21	12	6.3	M12	1	2.4	2.6	●
	BT40-FMC32-60	100	32	60	78	24	14	7.0	M16	2	2.1	2.3	●
	BT40-FMC40-50	125/160	40	50	89	27	15.87	8.0	M20	3	2.3	2.5	●
	BT50	BT50-FMC16-60	40	16	60	38	17	8	5.0	M8	1	3.9	4.2
BT50-FMC22-60		50/63	22	60	48	19	10	5.6	M10	1	4.1	4.4	●
BT50-FMC27-40		80	27	40	60	21	12	6.3	M12	1	3.8	4.1	●
BT50-FMC27-90		80	27	90	60	21	12	6.3	M12	1	4.8	5.1	●
BT50-FMC27-150		80	27	150	60	21	12	6.3	M12	1	6.1	6.5	●
BT50-FMC32-45		100	32	45	78	24	14	7.0	M16	1	4.1	4.4	●
BT50-FMC32-75		100	32	75	78	24	14	7.0	M16	1	5.2	5.5	●
BT50-FMC32-105		100	32	105	78	24	14	7.0	M16	1	6.3	6.6	●
BT50-FMC40-50		125/160	40	50	89	27	15.87	8.0	M20	2	4.6	4.9	●

(Unit : mm)

1:1 CHAT



SK-FMC

Face mill arbor



Fig.1

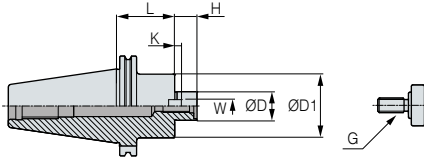

Fig.2

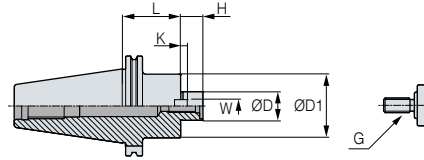
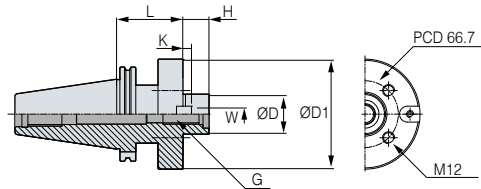

Fig.3



- ● : To be discontinued
- ● : Stock

■ Internal coolant system is optional

※ The relevant weight excludes the weight of the face cutter

• For more information on the related parts, see **149p**.

	Designation	Cutter diameter	ØD	L	ØD1	H	W	K	G	Fig.	Kg	Package weight(Kg)	Stock
SK30	SK30-FMC16-60	40	16	60	38	17	8	5.0	M8	1	0.8	0.8	●
	SK30-FMC22-50	50/63	22	50	48	19	10	5.6	M10	2	0.8	0.9	●
	SK30-FMC27-55	80	27	55	60	21	12	6.3	M12	2	1.1	1.2	●
SK40	SK40-FMC16-55	40	16	55	38	17	8	5.0	M8	1	1.2	1.4	●
	SK40-FMC22-55	50/63	22	55	48	19	10	5.6	M10	1	1.4	1.6	●
	SK40-FMC27-60	80	27	60	60	21	12	6.3	M12	2	1.6	1.8	●
	SK40-FMC32-60	100	32	60	78	24	14	7.0	M16	2	2.2	2.4	●
	SK40-FMC40-50	125/160	40	50	89	27	15.87	8.0	M20	3	2.3	2.5	●
SK50	SK50-FMC16-60	40	16	60	38	17	8	5.0	M8	1	2.9	3.2	●
	SK50-FMC22-60	50/63	22	60	48	19	10	5.6	M10	1	3.2	3.5	●
	SK50-FMC27-40	80	27	40	60	21	12	6.3	M12	1	3.2	3.5	●
	SK50-FMC32-45	100	32	45	78	24	14	7.0	M16	1	3.7	4.0	●
	SK50-FMC40-50	125/160	40	50	89	27	15.87	8.0	M20	3	4.2	4.5	●

(Unit : mm)



FMC SPARE PART

Face mill arbor related parts



Chuck

Arbor/Modular

Boring tool





Angular head

CBN/PCD

TAUMAX



Other

Main components

SPARE PART	Type	Main components			
		Key	Key bolt	Mount bolt	Clamp bolt
	Images				
	Model No.				
	FMC16	K8.0	BX0310	-	BX0830
	FMC22	K10.0	BX0412	-	BX1030
	FMC27	K12.0	BX0516	MBA-M12	BX1230
	FMC32	K14.0	BX0616	MBA-M16	-
	FMC40	K15.87	BX0616	MBA-M20	BX1230

※ BX1235 clamp bolts are used for SK40-FMC40-50.

Accessories

SPARE PART	Type	Accessories	Type	Accessories
		Wrench		Images
	Images		Images	
	Model No.		Model No.	
	FMC16	LW-6	HSK50A	HSK63A-CNS
	FMC22	LW-8	HSK63A	HSK100A-CNS
	FMC27	LW-10		
	FMC32	LW-14		
	FMC40	LW-17		



DBT-MD

Modular arbor

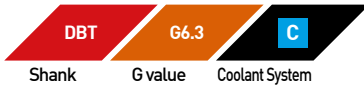

Fig.1

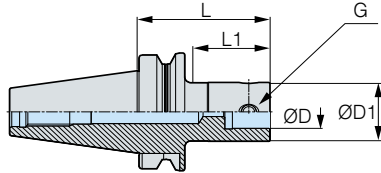

Fig.2

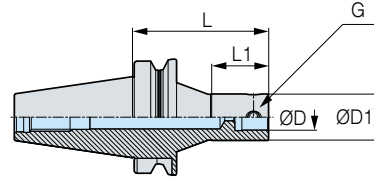

Fig.3

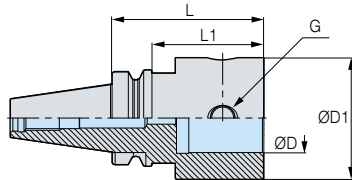
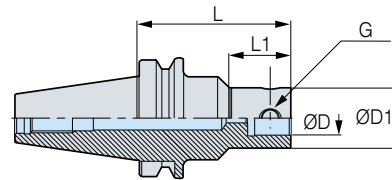

Fig.4



C Internal coolant system is basic

• For more information on the related parts, see **157p.**

	Designation	ØD	L	ØD1	L1	G	Fig.	Kg	Package weight(Kg)	Stock	
DBT30	DBT30-MD19F-70R	11	70	19	27	M5	4	0.5	0.6		
	DBT30-MD25F-90R	14	90	25	43	M6	4	0.6	0.7		
	DBT30-MD32F-80R	18	80	32	39	M8	4	0.7	0.8		
	DBT30-MD40F-45	22	45	40	24	M10	1	0.5	0.6		
	DBT30-MD40F-80R	22	80	40	49	M10	4	0.8	0.9		
	DBT30-MD50F-70	28	70	50	48	M12	3	0.9	1.0		
DBT40	DBT40-MD19F-70	11	70	19	43	M5	1	1.0	1.2		
	DBT40-MD25F-95	14	95	25	68	M6	1	1.1	1.3		
	DBT40-MD25F-105R	14	105	25	40	M6	2	1.2	1.4		
	DBT40-MD32F-100	18	100	32	70	M8	1	1.2	1.5		
	DBT40-MD32F-115R	18	115	32	45	M8	2	1.5	1.7		
	DBT40-MD40F-50	22	50	40	21	M10	1	1.2	1.4		
	DBT40-MD40F-110R	22	110	40	60	M10	2	1.6	1.8		
	DBT40-MD40F-115	22	115	40	83	M10	1	1.6	1.8		
	DBT40-MD50F-100R	28	100	50	50	M12	2	1.8	2.1		
	DBT40-MD50F-105	28	105	50	75	M12	1	1.9	2.1		
	DBT40-MD63F-64	36	64	63	37	M16	3	1.5	1.7		
	DBT40-MD63F-90	36	90	63	63	M16	3	2.1	2.3		
	DBT40-MD63F-110	36	110	63	83	M16	3	2.5	2.7		
	DBT40-MD80F-100	45	100	80	73	M16	3	2.9	3.1		

(Unit : mm)



DBT-MD

Modular arbor



Fig.1

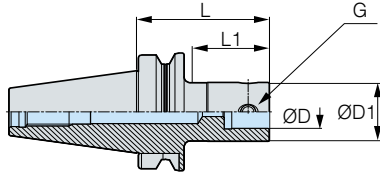

Fig.2

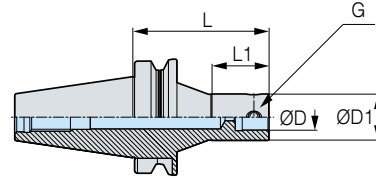

Fig.3

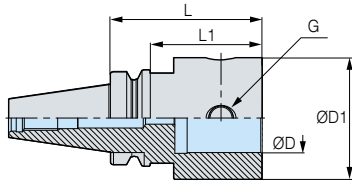
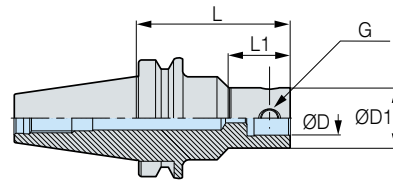

Fig.4



C Internal coolant system is basic

• For more information on the related parts, see **157p**.

	Designation	ØD	L	ØD1	L1	G	Fig.	Kg	Package weight(Kg)	Stock
DBT50	DBT50-MD19F-85	11	85	19	45	M5	1	3.7	4.0	
	DBT50-MD19F-100	11	100	19	60	M5	1	3.8	4.1	
	DBT50-MD25F-105	14	105	25	64	M6	1	3.9	4.2	
	DBT50-MD25F-120R	14	120	25	40	M6	2	4.0	4.4	
	DBT50-MD32F-110	18	110	32	67	M8	1	4.1	4.4	
	DBT50-MD32F-115R	18	115	32	45	M8	2	4.2	4.6	
	DBT50-MD32F-235R	18	235	32	115	M8	2	5.5	5.9	
	DBT50-MD40F-60	22	60	40	22	M10	1	3.7	4.0	
	DBT50-MD40F-125R	22	125	40	59	M10	2	4.3	4.7	
	DBT50-MD40F-145	22	145	40	102	M10	1	4.5	4.9	
	DBT50-MD40F-195R	22	195	40	83	M10	4	4.8	5.2	
	DBT50-MD40F-230R	22	230	40	180	M10	2	5.0	5.4	
	DBT50-MD50F-125	28	125	50	82	M12	1	4.6	5.0	
	DBT50-MD50F-160R	28	160	50	61	M12	2	5.8	6.2	
	DBT50-MD50F-225R	28	225	50	125	M12	4	6.0	6.4	
	DBT50-MD50F-250R	28	250	50	81	M12	2	7.0	7.4	
	DBT50-MD63F-75	36	75	63	35	M16	1	4.2	4.5	
	DBT50-MD63F-130	36	130	63	87	M16	1	5.3	5.7	
	DBT50-MD63F-140	36	140	63	97	M16	1	5.5	5.9	
	DBT50-MD63F-140R	36	140	63	70	M16	2	5.7	6.1	
DBT50-MD63F-195R	36	195	63	120	M16	4	6.8	7.2		
DBT50-MD63F-230R	36	230	63	149	M16	4	7.5	7.9		
DBT50-MD63F-240R	36	240	63	190	M16	2	7.8	8.2		
DBT50-MD80F-75	45	75	80	36	M16	1	4.4	4.7		
DBT50-MD80F-110	45	110	80	69	M16	1	5.8	6.1		
DBT50-MD80F-160	45	160	80	119	M16	1	8.0	8.4		
DBT50-MD90F-75	45	75	90	37	M16	1	4.8	5.1		
DBT50-MD90F-145	45	145	90	107	M16	1	7.4	7.8		

(Unit : mm)

Chuck

Arbor/Modular

Boring tool

Angular head

CBN/PCD

TAUMAX

Other



BT-MD

Modular arbor



MAS
403-BT

Shank

G6.3

G value

C

Coolant System

Fig.1

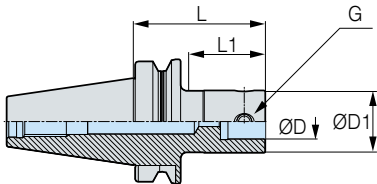

Fig.2

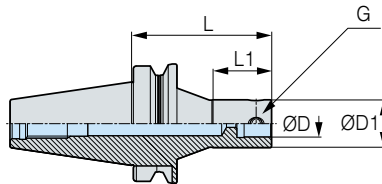
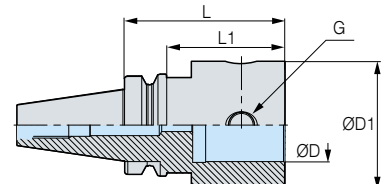

Fig.3



● : Stock

C Internal coolant system is basic

• For more information on the related parts, see **157p.**

	Designation	ØD	L	ØD1	L1	G	Fig.	Kg	Package weight(Kg)	Stock
BT30	BT30-MD19F-70	11	70	19	45	M5	1	0.5	0.5	●
	BT30-MD25F-90	14	90	25	63	M6	1	0.6	0.7	●
	BT30-MD32F-80	18	80	32	55	M8	1	0.7	0.7	●
	BT30-MD40F-45	22	45	40	22	M10	1	0.5	0.6	●
	BT30-MD40F-60	22	60	40	36	M10	1	0.7	0.7	●
	BT30-MD40F-80	22	80	40	56	M10	1	0.9	0.9	●
	BT30-MD50F-70	28	70	50	48	M12	3	0.9	1.0	●
BT40	BT40-MD19F-70	11	70	19	40	M5	1	1.0	1.2	●
	BT40-MD25F-95	14	95	25	63	M6	1	1.1	1.3	●
	BT40-MD25F-105R	14	105	25	40	M6	2	1.2	1.4	●
	BT40-MD32F-100	18	100	32	70	M8	1	1.2	1.5	●
	BT40-MD32F-115R	18	115	32	45	M8	2	1.5	1.8	●
	BT40-MD40F-60	22	60	40	31	M10	1	1.1	1.3	●
	BT40-MD40F-110R	22	110	40	60	M10	2	1.6	1.9	●
	BT40-MD40F-115	22	115	40	83	M10	1	1.6	1.8	●
	BT40-MD50F-60	28	60	50	30	M12	1	1.3	1.5	
	BT40-MD50F-100R	28	100	50	50	M12	2	1.8	2.1	
	BT40-MD50F-105	28	105	50	73	M12	1	1.8	2.1	●
	BT40-MD63F-64	36	64	63	37	M16	3	1.5	1.7	●
	BT40-MD63F-90	36	90	63	63	M16	3	2.0	2.3	
	BT40-MD63F-110	36	110	63	83	M16	3	2.4	2.6	●
	BT40-MD63F-135	36	135	63	108	M16	3	3.0	3.3	●
	BT40-MD80F-100	45	100	80	73	M16	3	2.9	3.1	●

(Unit : mm)



BT-MD

Modular arbor



Shank

G value

Coolant System



Fig.1

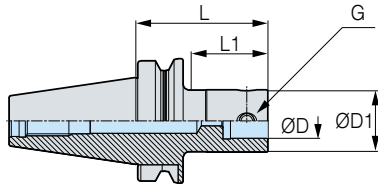
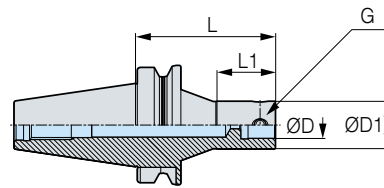

Fig.2



● : Stock

C Internal coolant system is basic

• For more information on the related parts, see **157p**

	Designation	ØD	L	ØD1	L1	G	Fig.	Kg	Package weight(Kg)	Stock
BT50	BT50-MD19F-85	11	85	19	44	M5	1	3.7	4.0	●
	BT50-MD19F-100	11	100	19	59	M5	1	3.7	4.0	●
	BT50-MD25F-105	14	105	25	62	M6	1	3.8	4.1	●
	BT50-MD25F-120R	14	120	25	40	M6	2	3.8	4.1	●
	BT50-MD32F-110	18	110	32	67	M8	1	4.0	4.3	●
	BT50-MD32F-115R	18	115	32	45	M8	2	4.1	4.5	●
	BT50-MD32F-235R	18	235	32	115	M8	2	5.5	5.9	●
	BT50-MD40F-60	22	60	40	22	M10	1	3.7	4.0	●
	BT50-MD40F-125R	22	125	40	59	M10	2	3.8	4.1	
	BT50-MD40F-145	22	145	40	102	M10	1	4.3	4.7	
	BT50-MD40F-195	22	195	40	152	M10	1	4.8	5.2	●
	BT50-MD40F-230R	22	230	40	180	M10	2	5.0	5.4	●
	BT50-MD50F-125	28	125	50	82	M12	1	4.6	5.0	●
	BT50-MD50F-160R	28	160	50	61	M12	2	5.7	6.1	
	BT50-MD50F-225	28	225	50	182	M12	1	6.0	6.4	●
	BT50-MD50F-250R	28	250	50	81	M12	2	7.0	7.4	●
	BT50-MD63F-75	36	75	63	35	M16	1	4.2	4.5	●
	BT50-MD63F-130	36	130	63	87	M16	1	5.3	5.7	●
	BT50-MD63F-140	36	140	63	97	M16	1	5.5	5.9	
	BT50-MD63F-140R	36	140	63	80	M16	2	5.7	6.1	
	BT50-MD63F-195	36	195	63	152	M16	1	6.8	7.2	●
	BT50-MD63F-230	36	230	63	187	M16	1	7.5	7.9	●
	BT50-MD63F-240R	36	240	63	190	M16	2	7.8	8.2	
	BT50-MD80F-75	45	75	80	36	M16	1	4.3	4.6	●
	BT50-MD80F-110	45	110	80	69	M16	1	5.7	6.0	●
	BT50-MD80F-175	45	175	80	134	M16	1	8.0	8.4	●
BT50-MD90F-75	45	75	90	36	M16	1	4.8	5.1	●	
BT50-MD90F-145	45	145	90	104	M16	1	7.4	7.8	●	
BT50-MD90F-195	45	195	90	154	M16	1	9.4	9.8	●	

(Unit : mm)

Chuck

Arbor/Modular

Boring tool

Angular head

cBN/PCD

TAUMAX

Other



HSK-MD

Modular arbor



DIN 69893-1
G6.3
C

Shank G value Coolant System

Fig.1

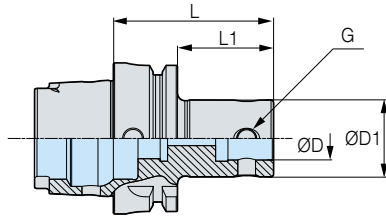
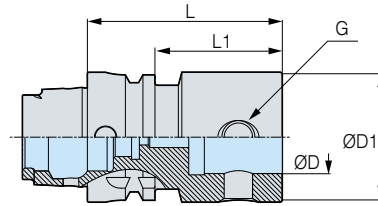

Fig.2



● : Stock

c Internal coolant system is optional

• For more information on the related parts, see **157p**.

	Designation	ØD1	L	ØD2	L1	H	M	Fig.	Kg	Package weight(Kg)	Stock
HSK63A	HSK63A-MD19F-60	11	60	19	31	15.5	M5	1	0.7	0.9	●
	HSK63A-MD25F-60	14	60	25	31	18.5	M6	1	0.7	0.9	●
	HSK63A-MD32F-65	18	65	32	36	23.5	M8	1	0.8	1.0	●
	HSK63A-MD40F-70	22	70	40	41	29.0	M10	1	0.9	1.1	●
	HSK63A-MD50F-85	28	85	50	58	36.0	M12	1	1.3	1.5	●
	HSK63A-MD63F-95	36	95	63	69	46.0	M16	2	1.7	1.9	●
HSK100A	HSK100A-MD19F-60	11	60	19	19	15.5	M5	1	2.1	2.3	
	HSK100A-MD25F-60	14	60	25	20	18.5	M6	1	2.1	2.3	
	HSK100A-MD32F-65	18	65	32	26	23.5	M8	1	2.1	2.4	
	HSK100A-MD40F-70	22	70	40	38	29	M10	1	2.3	2.6	
	HSK100A-MD50F-80	28	80	50	48	36	M12	1	2.6	2.9	
	HSK100A-MD63F-90	36	90	63	58	46	M16	1	3.0	3.4	
	HSK100A-MD80F-105	45	105	80	73	57	M16	1	4.2	4.5	
	HSK100A-MD90F-105	45	105	90	76	57	M16	1	4.7	5.0	

(Unit : mm)

SPARE PART	Type	Accessories	
			Coolant tube for HSK
	Images		
	Model No.		
	HSK63A		HSK63A-CNS
	HSK100A		HSK100A-CNS



SK-MD

Modular arbor



DIN69871
-1A/B
G6.3
C

Shank G value Coolant System

Fig.1

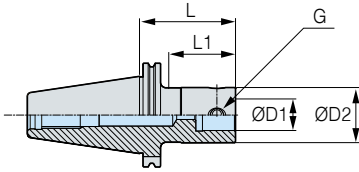

Fig.2

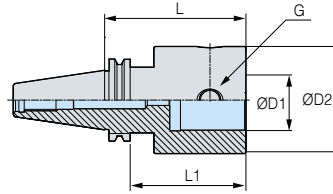
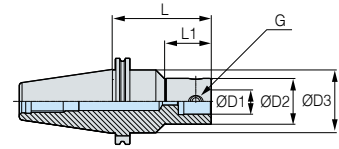

Fig.3



• ● : Stock

C Internal coolant system is basic

• For more information on the related parts, see **157p**.

	Designation	ØD1	L	ØD2	ØD3	L1	G	Fig.	Kg	Package weight(Kg)	Stock	
SK40	SK40-MD19F-80R	11	80	19	30	12	M5	3	1.0	1.2	●	
	SK40-MD25F-80R	14	80	25	35	22	M6	3	1.1	1.3	●	
	SK40-MD32F-115R	18	115	32	42	36	M8	3	1.5	1.7	●	
	SK40-MD40F-60	22	60	40	-	40	M10	1	1.1	1.3	●	
	SK40-MD40F-100	22	100	40	-	79	M10	1	1.4	1.6	●	
	SK40-MD50F-75	28	75	50	-	55	M10	1	1.5	1.7	●	
	SK40-MD50F-100	28	100	50	-	80	M12	1	1.8	2.0	●	
	SK40-MD63F-70	36	70	63	-	50	M16	2	1.4	1.6	●	
SK50	SK50-MD19F-85R	11	85	19	40	12	M5	3	3.0	3.3	●	
	SK50-MD25F-80R	14	80	25	44	22	M6	3	3.1	3.4	●	
	SK50-MD25F-105R	14	105	25	44	22	M6	3	3.3	3.6	●	
	SK50-MD32F-110	18	110	32	-	87	M8	1	3	3.3	●	
	SK50-MD32F-110R	18	110	32	50	36	M8	3	3.5	3.8	●	
	SK50-MD40F-100	22	100	40	-	75	M10	1	3.2	3.5	●	
	SK50-MD40F-145	22	145	40	-	120	M10	1	3.5	3.9	●	
	SK50-MD40F-220R	22	220	40	60	83	M10	3	5.6	6.0	●	
	SK50-MD50F-125R	28	125	50	65	60	M12	3	4.3	4.6	●	
	SK50-MD50F-240R	28	240	50	65	125	M12	3	6.6	7.0	●	
	SK50-MD63F-75	36	75	63	-	52	M16	1	3.6	3.9	●	
	SK50-MD63F-130	36	130	63	-	107	M16	1	4.7	5.1	●	
	SK50-MD63F-230R	36	230	63	80	149	M16	3	7.9	8.3	●	
	SK50-MD80F-95	45	95	80	-	75	M16	1	4.8	5.1	●	
	SK50-MD80F-150	45	150	80	-	130	M16	1	6.8	7.2	●	
	SK50-MD90F-115	45	115	90	-	95	M16	2	6.3	6.6	●	
	SK50-MD90F-165	45	165	90	-	145	M16	2	8.1	8.5	●	

(Unit : mm)

Chuck

Arbor/Modular

Boring tool

Angular head

CBN/PCD

TAUMAX

Other

1:1 CHAT



EXT

Extension bar



Coolant System

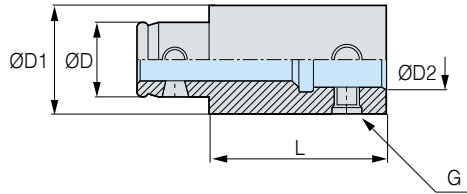

• ● : Stock

C Internal coolant system is basic

	Designation	ØD	L	ØD1	ØD2	G	Kg	Package weight(Kg)	Stock
EXT	EXT1930F	11	30	19	11	M5	0.1	0.1	●
	EXT1950F	11	50	19	11	M5	0.1	0.1	●
	EXT2530F	14	30	25	14	M6	0.1	0.1	●
	EXT2550F	14	50	25	14	M6	0.2	0.2	●
	EXT3235F	18	35	32	18	M8	0.2	0.2	●
	EXT3260F	18	60	32	18	M8	0.4	0.4	●
	EXT4040F	22	40	40	22	M10	0.4	0.4	●
	EXT4090F	22	90	40	22	M10	0.9	0.9	●
	EXT5050F	28	50	50	28	M12	0.7	0.7	●
	EXT50100F	28	100	50	28	M12	1.4	1.5	●
	EXT6360F	36	60	63	36	M16	1.4	1.5	●
	EXT63120F	36	120	63	36	M16	2.9	2.9	●
	EXT8070F	45	70	80	45	M16	2.5	2.7	●
	EXT80120F	45	120	80	45	M16	4.5	4.7	●
EXT9080F	45	80	90	45	M16	3.8	4.0	●	
EXT90130F	45	130	90	45	M16	6.4	6.6	●	

(Unit : mm)

1:1 CHAT



RDC

Reducer bar



Coolant System

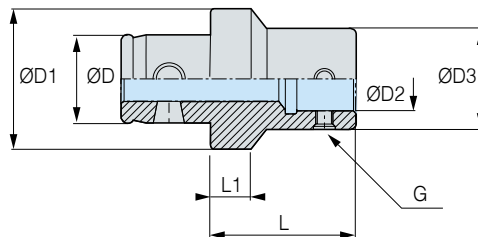

• ● : Stock

C Internal coolant system is basic

	Designation	ØD	L	ØD1	ØD2	ØD3	L1	G	Kg	Package weight(Kg)	Stock
RDC	RDC3225F	18	30	32	14	25	9	M6	0.1	0.2	●
	RDC4025F	22	30	40	14	25	9	M6	0.3	0.3	●
	RDC4032F	22	30	40	18	32	9	M8	0.2	0.2	●
	RDC5025F	28	30	50	14	25	9	M6	0.3	0.4	●
	RDC5032F	28	40	50	18	32	9	M8	0.3	0.4	●
	RDC5040F	28	40	50	22	40	10	M10	0.5	0.6	●
	RDC6325F	36	30	63	14	25	9	M6	0.6	0.7	●
	RDC6332F	36	40	63	18	32	9	M8	0.6	0.7	●
	RDC6340F	36	40	63	22	40	10	M10	0.7	0.8	●
	RDC6350F	36	45	63	28	50	10	M12	0.9	1.0	●
	RDC8040F	45	40	80	22	40	10	M10	1.2	1.4	●
	RDC8050F	45	45	80	28	50	10	M12	1.3	1.5	●
	RDC8063F	45	50	80	36	63	13	M16	1.6	1.8	●

(Unit : mm)



MD SPARE PART

Modular arbor related parts



Chuck

Arbor/Modular

Boring tool

Angular head

CBN/PCD

TAUMAX

Other

Main components

SPARE PART	Type	Main components
	Images	Taper screw
	Model No.	
	MD19F	BTT0506F
	MD25F	BTT0608F
	MD32F	BTT0810F
	MD40F	BTT1013F
	MD50F	BTT1215F
	MD63F	BTT1620F
	MD80F	BTT1626F
	MD90F	BTT1631F

Accessories

SPARE PART	Accessories
	Wrench
	
	LW-2.5
	LW-3
	LW-4
	LW-5
	LW-6
	LW-8
	LW-8
	LW-8

SPARE PART	Type	Accessories
	Images	Coolant tube for HSK
	Model No.	
	HSK63A	HSK63A-CNS



Boring Tool

DINOX NC TOTAL TOOLING SYSTEM

FBH/B	160
DBCA	170
DBC	180
TBCA	186
TBC	192
FBC	197
SMB	202
KMB	204
SMH	206
BB BITE	210
BH	211
BSA	212
BKA	214
FZ UNIT	216
BCF	218
FF	220



FBH/B

FBH Back boring & balanced type



G6.3 **C**

G value Coolant System Boring

Features

- High-speed boring and back boring applicable
- High-precision balanced boring : G6.3
- Minimum adjustment range : 2μm

NAMING	FBH	32	33	B
	Fine boring head	MD Arbor Size	Boring Range(Min)	Balance type



Back boring range calculation



Designation	Min. diameter for pass(∅) 'C'
FBH1920B	≥∅24
FBH2526B	≥∅30.5
FBH3233B	≥∅35
FBH4042B	≥∅44
FBH5053B	≥∅54
FBH6368B	≥∅71.5
FBH6398B	≥∅100
FBH8098B	≥∅100

A	Max. range of back boring (∅)	A Max. value = (2xC)-B
B	Max. FBH body size (∅)	B Max. value = (2xC)-A
C	Min. diameter for pass (∅)	C Min. value = (A+B)/2

Dial adjustment

Fine adjustment : 2μm boring range

Can be adjusted at a rate of 2μm by using the main scale and vernier scale

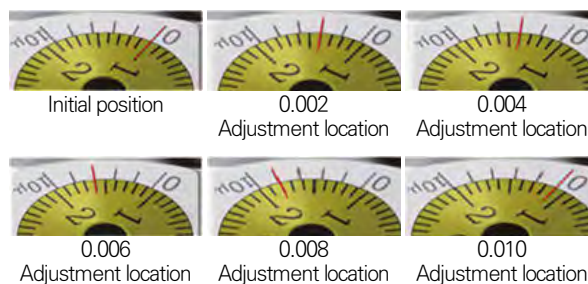

Back boring machining

Before machining

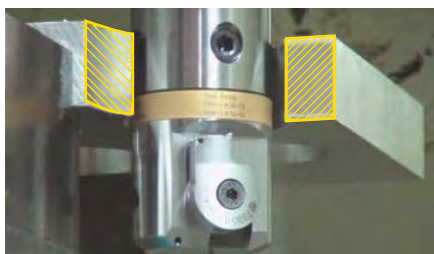

After machining

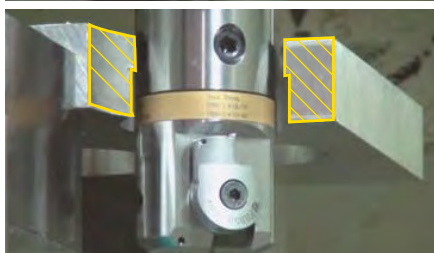

Convertible for machining direction

In case of boring machining

In case of back boring machining



※ Boring direction can be easily shifted simply by changing the bite direction



FBH/B

FBH Back boring & balanced type



Test Results

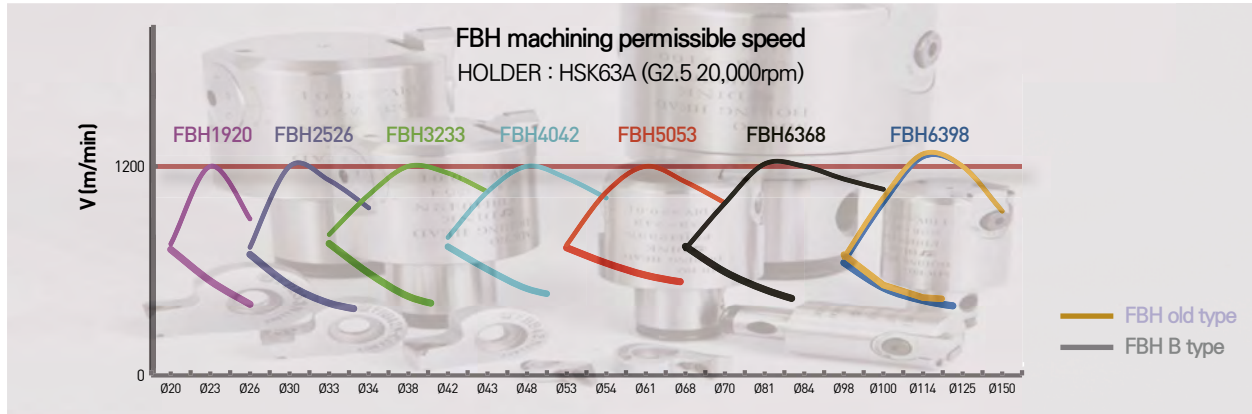

Chuck	Designation	FBH2526B	FBH2526N
		V(m/min)	732 (6,861rpm)
HSK63A-MD25F-60	Difference in surface roughness		
		<ul style="list-style-type: none"> • Constant and regular cycles are shown on the graph • Indicates stable boring work at high cutting speed 	<ul style="list-style-type: none"> • Irregular cycles shown on the graph • Indicates unstable boring work at high cutting speed

Boring range

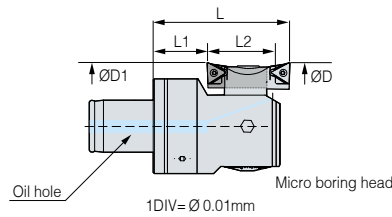

Designation	Boring Range(Ø)			Backboring Range(ØD1)			
	Min.	Max.	L	Min.	Max.	L1	L2
FBH1920B	20	26(30)	35	29	30	13	19
FBH2526B	26	34(40)	41	36	40	15	22
FBH3233B	33	43(50)	41	38	43(50)	13	25
FBH4042B	42	54(62)	50	48	54(62)	15	31
FBH5053B	53	70(82)	58	58	70(82)	16	38
FBH6368B	68	100(122)	81	78	100(122)	27	49
FBH6398B	98	150(172)	101	106	150(172)	47	49
FBH8098B	98	150(172)	101	106	150(172)	47	49

(Unit : mm)

Chuck

Arbor/Modular

Boring tool

Angular head

CBN/PCD

TAUMAX

Other



BT-FBH/B

Micro boring bar (balanced type)



Fig.1

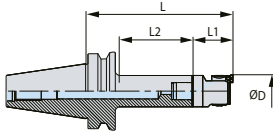

Fig.2

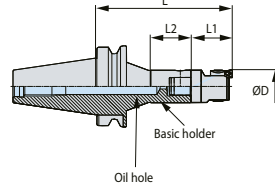
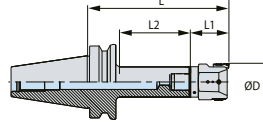
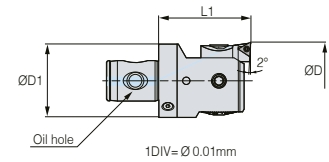

Fig.3



Head



● : Stock

C Internal coolant system is basic

※ **Red** : Main component **Blue** : For separate purchase

• For more information on the product features, see **160p**.

• For more information on MD arbor, see **152p**.

• For more information on the related parts, see **168p**.

• For more information on FBB bite, see **169p**.

	Designation					Boring range(ØD)		L	L1	L2	ØD1	Head weight(Kg)	Head package weight(Kg)	Fig.	
	Head model no.	Stock	Bite model no.	Stock	Arbor Model No.	Stock	Min.								Max.
BT30	FBH1920B	●	FBB20N-□-□□	●	BT30-MD19F-70	●	20(24)	26(30)	105	35	45	19	0.2	0.2	1
	FBH2526B	●	FBB26N-□-□□	●	BT30-MD25F-90	●	26(32)	34(40)	131	41	63	25	0.2	0.2	1
	FBH3233B	●	FBB33N-□-□□	●	BT30-MD32F-80	●	33(40)	43(50)	121	41	55	32	0.3	0.3	1
	FBH4042B	●	FBB42N-□-□□	●	BT30-MD40F-45	●	42(50)	54(62)	95	50	22	40	0.5	0.5	1
	FBH4042B	●	FBB42N-□-□□	●	BT30-MD40F-60	●	42(50)	54(62)	110	50	36	40	0.5	0.5	1
	FBH4042B	●	FBB42N-□-□□	●	BT30-MD40F-80	●	42(50)	54(62)	130	50	56	40	0.5	0.5	1
	FBH5053B	●	FBB53N-□-□□	●	BT30-MD50F-70	●	53(65)	70(82)	128	58	48	50	0.8	0.9	1
BT40	FBH1920B	●	FBB20N-□-□□	●	BT40-MD19F-70	●	20(24)	26(30)	105	35	40	19	0.2	0.2	1
	FBH2526B	●	FBB26N-□-□□	●	BT40-MD25F-95	●	26(32)	34(40)	136	41	63	25	0.2	0.2	1
	FBH2526B	●	FBB26N-□-□□	●	BT40-MD25F-105R	●	26(32)	34(40)	146	41	40	25	0.2	0.2	2
	FBH3233B	●	FBB33N-□-□□	●	BT40-MD32F-100	●	33(40)	43(50)	141	41	70	32	0.3	0.3	1
	FBH3233B	●	FBB33N-□-□□	●	BT40-MD32F-115R	●	33(40)	43(50)	156	41	45	32	0.3	0.3	2
	FBH4042B	●	FBB42N-□-□□	●	BT40-MD40F-60	●	42(50)	54(62)	110	50	31	40	0.5	0.5	1
	FBH4042B	●	FBB42N-□-□□	●	BT40-MD40F-110R	●	42(50)	54(62)	160	50	60	40	0.5	0.5	2
	FBH4042B	●	FBB42N-□-□□	●	BT40-MD40F-115	●	42(50)	54(62)	165	50	83	40	0.5	0.5	1
	FBH5053B	●	FBB53N-□-□□	●	BT40-MD50F-105	●	53(65)	70(82)	163	58	73	50	0.8	0.9	1
	FBH5053B	●	FBB53N-□-□□	●	BT40-MD50F-64	●	53(65)	70(82)	122	58	37	28	0.8	0.9	1
	FBH6368B	●	FBB68N-□-□□	●	BT40-MD63F-110	●	68(90)	100(122)	191	81	83	65	2.1	2.3	1
	FBH6398B	●	FBB68N-□-□□	●	BT40-MD63F-135	●	98(120)	150(172)	236	101	108	94	3.6	3.8	3
	FBH8098B	●	FBB68N-□-□□	●	BT40-MD80F-100	●	98(120)	150(172)	201	101	73	94	4.8	5.1	3

• In the above table, the Arbor Model No. is an example model no. and able to adjust the depth of boring with a combination of MD arbors and extension bars. For more details, see the MD arbor page.

(Unit : mm)

• FBB bite is largely divided into general-type FBB□□N and extended-type (back boring) FBB□□N-1 and is available as FBB□□N-□-C09, FBB□□N-□-T11 depending on the insert.

Bite	Applicable insert
FBB□□N, FBB□□N-1	TPGT, TPGW0802□□□□L
FBB□□N-□-C	CCMT, CCGT0602□□□□L
FBB□□N-□-C09	CCMT, CCGT09T3□□□□L
FBB□□N-□-T11	TPGT1103□□□□L



BT-FBH/B

Micro boring bar (balanced type)



Fig.1

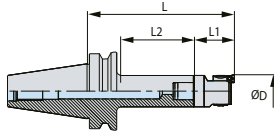

Fig.2

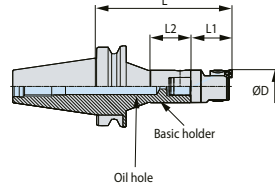
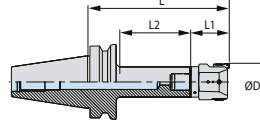
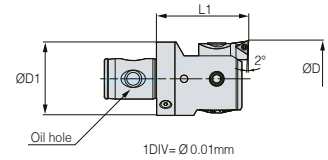

Fig.3



Head



● : Stock

C Internal coolant system is basic

※ Red : Main component Blue : For separate purchase

• For more information on the product features, see **160p**

• For more information on MD arbor, see **153p**

• For more information on the related parts, see **168p**

• For more information on FBB bite, see **169p**

	Designation					Boring range(ØD)		L	L1	L2	ØD1	Head weight(Kg)	Head package weight(Kg)	Fig	
	Head model no.	Stock	Bite model no.	Stock	Arbor Model No.	Stock	Min.								Max.
BT50	FBH1920B	●	FBB20N-□-□□	●	BT50-MD19F-85	●	20(24)	26(30)	120	35	44	19	0.2	0.2	1
	FBH2526B	●	FBB26N-□-□□	●	BT50-MD25F-105	●	26(32)	34(40)	146	41	62	25	0.2	0.2	1
	FBH2526B	●	FBB26N-□-□□	●	BT50-MD25F-120R	●	26(32)	34(40)	161	41	40	25	0.2	0.2	2
	FBH3233B	●	FBB33N-□-□□	●	BT50-MD32F-110	●	33(40)	43(50)	151	41	67	32	0.3	0.3	1
	FBH3233B	●	FBB33N-□-□□	●	BT50-MD32F-115R	●	33(40)	43(50)	156	41	45	32	0.3	0.3	2
	FBH3233B	●	FBB33N-□-□□	●	BT50-MD32F-235R	●	33(40)	43(50)	276	41	115	32	0.3	0.3	2
	FBH4042B	●	FBB42N-□-□□	●	BT50-MD40F-60	●	42(50)	54(62)	110	50	22	32	0.5	0.5	1
	FBH4042B	●	FBB42N-□-□□	●	BT50-MD40F-195	●	42(50)	54(62)	245	50	152	40	0.5	0.5	1
	FBH4042B	●	FBB42N-□-□□	●	BT50-MD40F-230R	●	42(50)	54(62)	280	50	180	40	0.5	0.5	2
	FBH5053B	●	FBB53N-□-□□	●	BT50-MD50F-125	●	53(65)	70(82)	183	58	82	40	0.8	0.9	1
	FBH5053B	●	FBB53N-□-□□	●	BT50-MD50F-225	●	53(65)	70(82)	283	58	182	50	0.8	0.9	1
	FBH5053B	●	FBB53N-□-□□	●	BT50-MD50F-250R	●	53(65)	70(82)	308	58	81	50	0.8	0.9	2
	FBH6368B	●	FBB68N-□-□□	●	BT50-MD63F-75	●	68(90)	100(122)	156	81	35	65	2.1	2.3	1
	FBH6368B	●	FBB68N-□-□□	●	BT50-MD63F-130	●	68(90)	100(122)	211	81	87	65	2.1	2.3	1
	FBH6368B	●	FBB68N-□-□□	●	BT50-MD63F-195	●	68(90)	100(122)	276	81	152	65	2.1	2.3	1
	FBH6368B	●	FBB68N-□-□□	●	BT50-MD63F-230	●	68(90)	100(122)	311	81	187	65	2.1	2.3	1
	FBH6398B	●	FBB68N-□-□□	●	BT50-MD63F-75	●	98(120)	150(172)	176	101	37	94	3.6	3.8	3
	FBH6398B	●	FBB68N-□-□□	●	BT50-MD63F-130	●	98(120)	150(172)	231	101	87	94	3.6	3.8	3
	FBH6398B	●	FBB68N-□-□□	●	BT50-MD63F-195	●	98(120)	150(172)	296	101	152	94	3.6	3.8	3
	FBH6398B	●	FBB68N-□-□□	●	BT50-MD63F-230	●	98(120)	150(172)	331	101	187	94	3.6	3.8	3
FBH8098B	●	FBB68N-□-□□	●	BT50-MD80F-75	●	98(120)	150(172)	176	101	36	94	4.8	5.1	3	
FBH8098B	●	FBB68N-□-□□	●	BT50-MD80F-110	●	98(120)	150(172)	211	101	69	94	4.8	5.1	3	
FBH8098B	●	FBB68N-□-□□	●	BT50-MD80F-175	●	98(120)	150(172)	276	101	134	94	4.8	5.1	3	

• In the above table, the Arbor Model No. is an example model no. and able to adjust the depth of boring with a combination of MD arbors and extension bars. For more details, see the MD arbor page.

(Unit : mm)

• FBB bite is largely divided into general-type FBB□□N and extended-type (back boring) FBB□□N-1 and is available as FBB□□N-□-C09, FBB□□N-□-T11 depending on the insert.

Bite	Applicable insert
FBB□□N, FBB□□N-1	TPGT, TPGW0802□□□L
FBB□□N-□-C	CCMT, CCGT0602□□□L
FBB□□N-□-C09	CCMT, CCGT09T3□□□L
FBB□□N-□-T11	TPGT1103□□□L



HSK-FBH/B

Micro boring bar (balanced type)



Fig.1

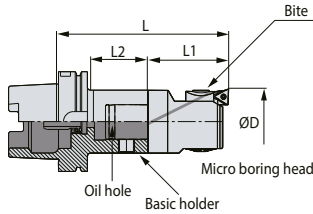
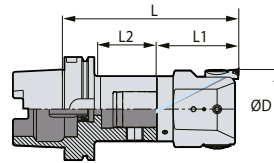
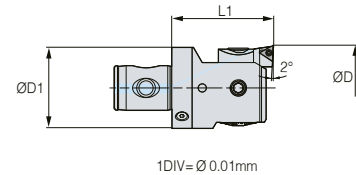

Fig.2



Head



● : Stock

C Internal coolant system is optional

※ **Red** : Main component **Blue** : For separate purchase

- For more information on the product features, see **160p**.
- For more information on MD arbor, see **154p**.
- For more information on the related parts, see **168p**.
- For more information on FBB bite, see **169p**.

Designation						Boring range[ØD]		L	L1	L2	ØD1	Head weight(Kg)	Head package weight(Kg)	Fig.
Head model no.	Stock	Bite model no.	Stock	Arbor Model No.	Stock	Min.	Max.							
FBH1920B	●	FBB20N-□-□□	●	HSK63A-MD19F-60	●	20(24)	26(30)	95	35	31	19	0.2	0.2	1
FBH2526B	●	FBB26N-□-□□	●	HSK63A-MD25F-60	●	26(32)	34(40)	101	41	31	25	0.2	0.2	1
FBH3233B	●	FBB33N-□-□□	●	HSK63A-MD32F-65	●	33(40)	43(50)	106	41	36	32	0.3	0.3	1
FBH4042B	●	FBB42N-□-□□	●	HSK63A-MD40F-70	●	42(50)	54(62)	120	50	41	40	0.5	0.5	1
FBH5053B	●	FBB53N-□-□□	●	HSK63A-MD50F-85	●	53(65)	70(82)	143	58	58	50	0.8	0.9	1
FBH6368B	●	FBB68N-□-□□	●	HSK63A-MD63F-95	●	68(90)	100(122)	176	81	69	65	2.1	2.3	1
FBH6398B	●	FBB68N-□-□□	●	HSK63A-MD63F-95	●	98(120)	150(172)	196	101	69	94	3.6	3.8	2

- In the above table, the Arbor Model No. is an example model no. and able to adjust the depth of boring with a combination of MD arbors and extension bars. For more details, see the MD arbor page.
- FBB bite is largely divided into general-type FBB□□N and extended-type (back boring) FBB□□N-1 and is available as FBB□□N-□-C09, FBB□□N-□-T11 depending on the insert.

(Unit : mm)

Bite	Applicable insert
FBB□□N, FBB□□N-1	TPGT, TPGW0802□□L
FBB□□N-□-C	CCMT, CCGT0602□□L
FBB□□N-□-C09	CCMT, CCGT09T3□□L
FBB□□N-□-T11	TPGT1103□□L

Accessories

SPARE PART	Type	Accessories
	Images	
	Model No.	HSK63A-CNS



SK-FBH/B

Micro boring bar (balanced type)



DIN69871 -1A/B	G6.3	C	26	172	
Shank	G value	Coolant System	MIN Range	MAX Range	Boring

Fig.1

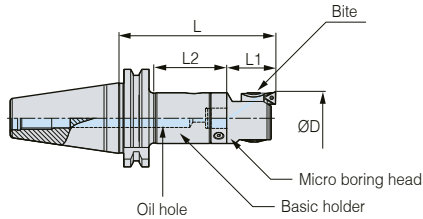

Fig.2

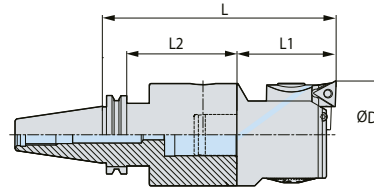
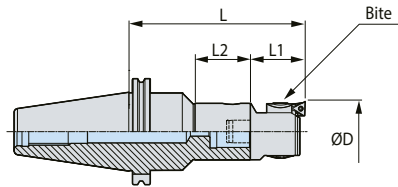
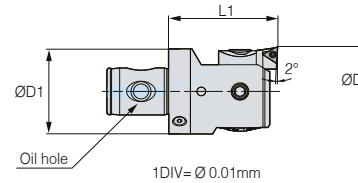

Fig.3



Head



● : Stock

C Internal coolant system is basic

※ **Red** : Main component **Blue** : For separate purchase

- For more information on the product features, see **160p**.
- For more information on MD arbor, see **154p**.
- For more information on the related parts, see **168p**.
- For more information on FBB bite, see **169p**.

	Designation					Boring range(ØD)		L	L1	L2	ØD1	Head weight(Kg)	Head package weight(Kg)	Fig.	
	Head model no.	Stock	Bite model no.	Stock	Arbor Model No.	Stock	Min.								Max.
SK40	FBH2526B	●	FBB26N-□-□□	●	SK40-MD25F-80R	●	26(32)	34(40)	121	41	22	25	0.2	0.2	3
	FBH3233B	●	FBB33N-□-□□	●	SK40-MD32F-115R	●	33(40)	43(50)	156	41	36	32	0.3	0.3	3
	FBH4042B	●	FBB42N-□-□□	●	SK40-MD40F-100	●	42(50)	54(62)	150	50	80	40	0.5	0.5	1
	FBH5053B	●	FBB53N-□-□□	●	SK40-MD50F-100	●	53(65)	70(82)	158	58	80	50	0.8	0.9	1
	FBH6368B	●	FBB68N-□-□□	●	SK40-MD63F-70	●	68(90)	100(122)	151	81	50	65	2.1	2.3	2
	FBH6398B	●	FBB68N-□-□□	●	SK40-MD63F-70	●	98(120)	150(172)	171	101	50	94	3.6	3.8	2
SK50	FBH2526B	●	FBB26N-□-□□	●	SK50-MD25F-105R	●	26(32)	34(40)	146	41	22	25	0.2	0.2	3
	FBH3233B	●	FBB33N-□-□□	●	SK50-MD32F-110	●	33(40)	43(50)	151	41	87	32	0.3	0.3	1
	FBH4042B	●	FBB42N-□-□□	●	SK50-MD40F-145	●	42(50)	54(62)	195	50	120	40	0.5	0.5	1
	FBH5053B	●	FBB53N-□-□□	●	SK50-MD50F-240R	●	53(65)	70(82)	298	58	125	50	0.8	0.9	3
	FBH6368B	●	FBB68N-□-□□	●	SK50-MD63F-130	●	68(90)	100(122)	211	81	107	65	2.1	2.3	1
	FBH6398B	●	FBB68N-□-□□	●	SK50-MD63F-130	●	98(120)	150(172)	231	101	107	94	3.6	3.8	1
	FBH8098B	●	FBB68N-□-□□	●	SK50-MD80F-150	●	98(120)	150(172)	251	101	130	94	4.8	5.1	1

• In the above table, the Arbor Model No. is an example model no. and able to adjust the depth of boring with a combination of MD arbors and extension bars. For more details, see the MD arbor page. (Unit : mm)

• FBB bite is largely divided into general-type FBB□□N and extended-type (back boring) FBB□□N-1 and is available as FBB□□N-□-C09, FBB□□N-□-T11 depending on the insert.

Bite	Applicable insert
FBB□□N, FBB□□N-1	TPGT, TPGW0802□□L
FBB□□N-□-C	CCMT, CCGT0602□□L
FBB□□N-□-C09	CCMT, CCGT09T3□□L
FBB□□N-□-T11	TPGT1103□□L

1:1 CHAT



S-FBH/B

Micro boring bar (balanced type)



Head

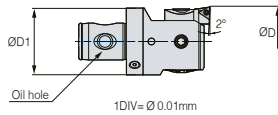
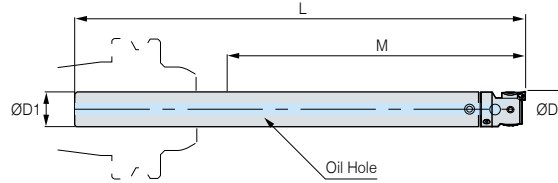

Fig.1



● : Stock

C Internal coolant system is basic

※ $\square\square\square W$: Cemented carbide shank / $\square\square\square$: Steel shank

• For more information on the product features, see **160p**.

• For more information on the related parts, see **168p**.

• For more information on FBB bite, see **169p**.

	Designation	Boring range		L	ØD1	M	Main component			Head weight(Kg)	Head package weight(Kg)	Stock
		Min.	Max.				Shank	Boring head	Bite			
Cemented CARBIDE	S19W-FBH20B-120	20	26	192	19	120	S19W-MD19F-157	FBH1920B	FBB20N	0.6	0.7	●
	S19W-FBH20B-140	20	26	212	19	140	S19W-MD19F-177	FBH1920B	FBB20N	0.7	0.8	●
	S19W-FBH20B-160	20	26	232	19	160	S19W-MD19F-197	FBH1920B	FBB20N	0.8	0.9	●
	S25W-FBH26B-150	26	34	238	25	150	S25W-MD25F-197.5	FBH2526B	FBB26N	1.4	1.5	●
	S25W-FBH26B-175	26	34	263	25	175	S25W-MD25F-222.5	FBH2526B	FBB26N	1.6	1.7	●
	S25W-FBH26B-200	26	34	288	25	200	S25W-MD25F-247.5	FBH2526B	FBB26N	1.8	1.9	●
	S32W-FBH33B-180	33	43	280	32	180	S32W-MD32F-239	FBH3233B	FBB33N	2.7	2.8	●
S32W-FBH33B-240	33	43	340	32	240	S32W-MD32F-299	FBH3233B	FBB33N	3.4	3.5	●	
Steel shank	S19-FBH20B-40	20	26	112	19	40	S19-MD19F-77	FBH1920B	FBB20N	0.2	0.3	●
	S19-FBH20B-80	20	26	152	19	80	S19-MD19F-117	FBH1920B	FBB20N	0.2	0.3	●
	S25-FBH26B-50	26	34	138	25	50	S25-MD25F-97.5	FBH2526B	FBB26N	0.4	0.5	●
	S25-FBH26B-100	26	34	188	25	100	S25-MD25F-147.5	FBH2526B	FBB26N	0.6	0.7	●
	S32-FBH33B-90	33	43	190	32	90	S32-MD32F-149	FBH3233B	FBB33N	1.1	1.2	●
	S32-FBH33B-120	33	43	220	32	120	S32-MD32F-179	FBH3233B	FBB33N	1.2	1.3	●

• FBB bite is largely divided into general-type FBB□□N and extended-type (back boring) FBB□□N-1 and is available as FBB□□N-□-C09, FBB□□N-□-T11 depending on the insert.

(Unit : mm)

Bite	Applicable insert
FBB□□N, FBB□□N-1	TPGT, TPGW0802□□L
FBB□□N-□-C	CCMT, CCGT0602□□L
FBB□□N-□-C09	CCMT, CCGT09T3□□L
FBB□□N-□-T11	TPGT1103□□L



S-FBH

Small micro boring bar with carbide/steel



CARBIDE
C
15
22

Shank Coolant System MIN Range MAX Range Boring

Head

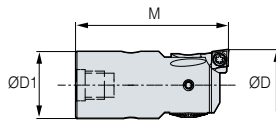
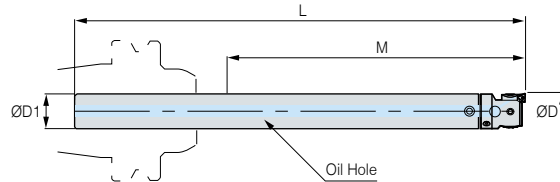

Fig.1



• ● : Stock

C Internal coolant system is basic

※ S□□W : Cemented carbide shank / S□□ : Steel shank

• For more information on the product features, see **160p**.

• For more information on the related parts, see **168p**.

• For more information on FBB bite, see **169p**.

	Designation	Boring range		L	ØD1	M	Main component			Head weight(Kg)	Head package weight(Kg)	Stock
		Min.	Max.				Shank	Boring head	Bite			
Cemented CARBIDE	S14W-FBH15-85	15	18	155	14	85	S14W-M6-123	FBH15	FBB15-C	0.3	0.4	●
	S14W-FBH15-110	15	18	180	14	110	S14W-M6-148	FBH15	FBB15-C	0.3	0.4	●
	S16W-FBH18-95	18	22	165	16	95	S16W-M8-128	FBH18	FBB15-C	0.4	0.5	●
	S16W-FBH18-125	18	22	195	16	125	S16W-M8-158	FBH18	FBB15-C	0.5	0.6	●
Steel shank	S14-FBH15-40	15	18	110	14	40	S14-M6-78	FBH15	FBB15-C	0.1	0.2	●
	S16-FBH18-45	18	22	115	16	45	S16-M8-78	FBH18	FBB15-C	0.1	0.2	●

(Unit : mm)

Bite	Applicable insert
FBB15-C	CCET0301□□-L

Chuck

Arbor/Modular

Boring tool

Angular head

CBN/PCD

TAUMAX

Other

1:1 CHAT





FBH/B SPARE PART

Micro boring balanced type related parts



SPARE PART

Main components			
Type(FBH/B)	Lock Screw	Clamp Screw	Wrench
			
FBH1920B	BTF0404	BXC0304	LW-2
FBH2526B	BTF0505	BXC0405	LW-2.5
FBH3233B	BTF0606	BXC0506	LW-3
FBH4042B	BTF0808	BXC0610	LW-4
FBH5053B	BTF0812	BXC0610	LW-4
FBH6368B	BTF1016	BXC0810	LW-5
FBH6398B	BTF1010	BXC0810	LW-5
FBH8098B	BTF1016	BXC0810	LW-5

1:1 CHAT







FBH SPARE PART

Micro boring related parts



SPARE PART

Main components			
Type(FBH)	Lock Screw	FBB	Clamp Screw
			
FBH15	BT0303	FBB15-C	BFTX02505N
FBH18	BT0304	FBB15-C	BFTX02505N



FBB BITE

Boring bite



NAMING

FBB	20	N	1	C
FBB Bite	Head No.	New Type	Non : General type 1 : Expansion type	Non : General type C, T : Insert type

SPARE PART

Designation	Boring range	Insert	Insert screw	Clamp bolt
FBB15-C [FBH15]	Ø15~Ø18mm	CCET0301□□L	BFTX01604N	BFTX02505N
FBB15-C [FBH15]	Ø18~Ø22mm	CCET0301□□L	BFTX01604N	BFTX02505N
FBB20N	Ø20~Ø26mm	TPGT0802□□L,TPGW0802□□	BFTX0204A	BXC0304
FBB20N-C	Ø20~Ø26mm	CCET0401□□L	FTNA0238	BXC0304
FBB20N-1	Ø24~Ø30mm	TPGT0802□□L,TPGW0802□□	BFTX0204A	BXC0304
FBB20N-1-C	Ø24~Ø30mm	CCET0401□□L	FTNA0238	BXC0304
FBB26N	Ø26~Ø34mm	TPGT0802□□L,TPGW0802□□	BFTX0204A	BXC0405
FBB26N-C	Ø26~Ø34mm	CCET0401□□L	FTNA0238	BXC0405
FBB26N-1	Ø32~Ø40mm	TPGT0802□□L,TPGW0802□□	BFTX0204A	BXC0405
FBB26N-1-C	Ø32~Ø40mm	CCET0401□□L	FTNA0238	BXC0405
FBB33N	Ø33~Ø43mm	TPGT0802□□L,TPGW0802□□	BFTX0204A	BXC0506
FBB33N-C	Ø33~Ø43mm	CCMT0602□□,CCGT0602□□	BFTX02506N	BXC0506
FBB33N-1	Ø41~Ø50mm	TPGT0802□□L,TPGW0802□□	BFTX0204A	BXC0506
FBB33N-1-C	Ø41~Ø50mm	CCMT0602□□,CCGT0602□□L	BFTX02506N	BXC0506
FBB42N	Ø42~Ø54mm	TPGT0802□□L,TPGW0802□□	BFTX0204A	BXC0610
FBB42N-C	Ø42~Ø54mm	CCMT0602□□,CCGT0602□□L	BFTX02506N	BXC0610
FBB42N-11	Ø42~Ø54mm	TPGT1103□□L	BFTX0307A	BXC0610
FBB42N-1	Ø50~Ø62mm	TPGT0802□□L,TPGW0802□□	BFTX0204A	BXC0610
FBB42N-1-C	Ø50~Ø62mm	CCMT0602□□,CCGT0602□□L	BFTX02506N	BXC0610
FBB42N-1-T11	Ø50~Ø62mm	TPGT1103□□L	BFTX0307A	BXC0610
FBB53N	Ø53~Ø70mm	TPGT0802□□L,TPGW0802□□	BFTX0204A	BXC0610
FBB53N-C	Ø53~Ø70mm	CCMT0602□□,CCGT0602□□	BFTX02506N	BXC0610
FBB53N-11	Ø53~Ø70mm	TPGT1103□□L	BFTX0307A	BXC0610
FBB53N-1	Ø65~Ø82mm	TPGT0802□□L,TPGW0802□□	BFTX0204A	BXC0610
FBB53N-1-C	Ø65~Ø82mm	CCMT0602□□,CCGT0602□□L	BFTX02506N	BXC0610
FBB53N-1-C09	Ø65~Ø82mm	CCMT09T3□□,CCGT09T3□□L	BFTX0409N	BXC0610
FBB53N-1-T11	Ø65~Ø82mm	TPGT1103□□L	BFTX0307A	BXC0610
FBB68N	Ø68~Ø100mm/Ø98~Ø150mm	TPGT0802□□L,TPGW0802□□	BFTX0204A	BXC0810
FBB68N-C	Ø68~Ø100mm/Ø98~Ø150mm	CCMT09T3□□,CCGT09T3□□L	BFTX0409N	BXC0810
FBB68N-11	Ø68~Ø100mm/Ø98~Ø150mm	TPGT1103□□L	BFTX0307A	BXC0810
FBB68N-1	Ø90~Ø122mm/Ø120~Ø172mm	TPGT0802□□L,TPGW0802□□	BFTX0204A	BXC0810
FBB68N-1-C09	Ø90~Ø122mm/Ø120~Ø172mm	CCMT09T3□□,CCGT09T3□□L	BFTX0409N	BXC0810
FBB68N-1-T11	Ø90~Ø122mm/Ø120~Ø172mm	TPGT1103□□L	BFTX0307A	BXC0810

Chuck

Arbor/Modular

Boring tool

Angular head

CBN/PCD

TAUMAX

Other

1:1 CHAT



DBCA

New balance cut tool



C	28	130	
Coolant System	MIN Range	MAX Range	Boring

Features

- Applied adjustment function simultaneously in Bi/Uni-direction of Cartridge
- Improves the rigidity of cutting by applying Cover for rotating type
- Increased machining area versus conventional own products
- Improved capacity to evacuate chips by unique design of Helical Type Head
- Boring range : $\varnothing 28 - \varnothing 136$



NAMING

DBCA	32	33	S	H
New balance cut tool	MD Arbor Size	Min. boring type dia.	Straight type	H : Helical type, Non : Straight type

Main Features

Helical Type

- Improved capacity to discharge chips from clogged and deep holes
- Minimized damage to tools and insert due to chip clogging

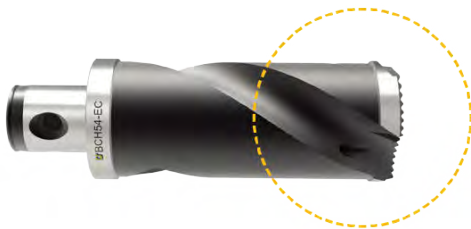

Boring area optimization

- Max. diameter expanded owing to reinforced rigidity
- Boring range expanded per model no. versus conventional boring range of DINE

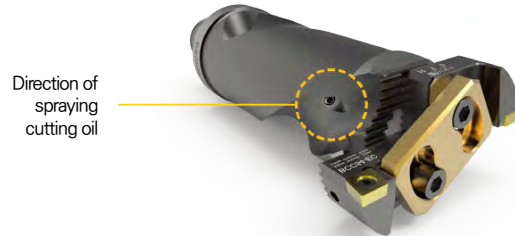

Extended head length	Deep hole machining implemented
Helical Type	Improved capacity to discharge chips from holes

Coolant Hole (Direct spray to cutting edge)	<ul style="list-style-type: none"> • Improved capacity to discharge chips • Improved capacity of machining
---------------------------------------------	------------------------------------------------------------------------------------------------------------------------------------

Effect of improved rigidity for Cartridge by Cover

Clamps the top of the cartridge stably, minimizing the vibration of tools and improving the roughness of the working surface

Non-Covered	Covered
<p>Small contact area</p>	<p>Large contact area</p>

State of MIN machining diameter	State of MAX machining diameter



DBCA

New balance cut tool



Comparison with competitors

Verifying of less vibration due to improved rigidity and smooth chip discharge

→ Superior performance compared to competitors

Manufacturer	L/D	Surface roughness(Ra)	Special notes	Machined surface
Company A	5D	3.82	Vibration occurred	
Company B	5D	2.46	Vibration occurred Chips tangled	
DINE	5D	2.19	Well-machined surface No chip tangled	

New machining range versus old machining range of DINE

OLD TYPE

NEW TYPE



Designation	Boring Range ØD	
	Min.	Max.
DBC2528S	28	35
DBC3235S	35	46
DBC4046S	46	58
DBC5058S	58	74
DBC6347S	74	94
DBC8094S	94	120

Designation	Boring Range ØD	
	Min.	Max.
DBCA2528S-H	28	38
DBCA3238S-H	38	54
DBCA5054S-H	54	74
DBCA6374S-H	74	100
DBCA80100S-H	100	130

Detailed Specifications

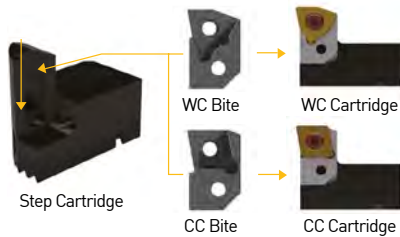

Designation	Cartridge (Standard)	Step Cartridge	Step Cartridge Bite	
			CC Type	WC Type
DBCA2528S-□	BCC28-EC	BCC28SB	SBB28-CC	SBB28-WC
DBCA3238S-□	BCC38-EC	BCC38SB	SBB28-CC	SBB28-WC
DBCA5054S-□	BCC54-EC	BCC54SB	SBB54-CC	SBB54-WC
DBCA6374S-□	BCC74-EC	BCC74SB	SBB74-CC	SBB74-WC
DBCA80100S-□	BCC100-EC	BCC100SB	SBB74-CC	SBB74-WC

Comparison with competitors

Machining conditions	Vc(m/min)	f(mm/rev)	ap(mm)	Material	Item	Depth of hall
	200	0.08	2	S45C	Penetration hall	30

Manufacturer	Insert	Gauge line (Head+Shank)	Boring diameter	L/D	Surface roughness(Ra)	Special notes	Machined surface	Tool top	Tool side
Competitor A	SCMT09T0304	164	Ø35	4.68	3.82	Vibration occurred			
Competitor B	CCMT080204	180	Ø35	5.14	2.46	Vibration occurred Chips tangled			
DINE	CCMT060204	175	Ø35	5	2.19	Well-machined surface No chip tangled			

Chuck

Arbor/Modular

Boring tool

Angular head

CBN/PCD

TAUMAX

Other



BT-DBCA-H (Helical Type)

New balance cut tool(Helical Type)



MAS 403-BT C 28 130 Boring

Shank Coolant System MIN Range MAX Range Boring

Fig.1

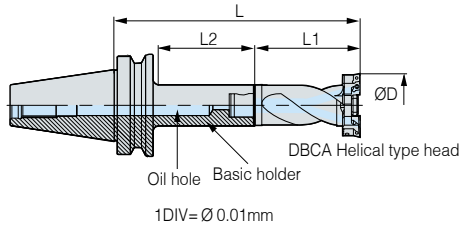

Fig.2

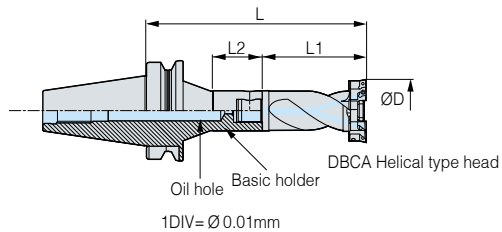
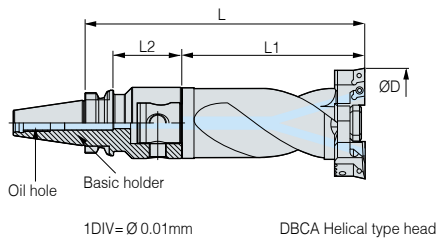
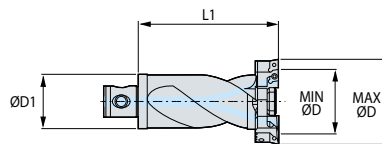

Fig.3



Head



● : Stock

C Internal coolant system is basic

※ **Red** : Main component **Blue** : For separate purchase

- For more information on the product features, see **170p**.
- For more information on MD arbor, see **152p**.
- For more information on the related parts, see **184p**.
- For more information on the applicable insert, see **185p**.

	Designation				Boring range(ØD)		L	L1	L2	ØD1	Fig.	Head weight(Kg)	Head package weight(Kg)
	Head model no.	Stock	Arbor Model No.	Stock	Min.	Max.							
BT30	DBCA2528S-H	●	BT30-MD25F-90	●	28	38	193	103	63	25	1	0.3	0.3
	DBCA3238S-H	●	BT30-MD32F-80	●	38	54	190	110	55	32	1	0.5	0.6
	DBCA5054S-H	●	BT30-MD50F-70	●	54	74	215	145	48	50	3	1.8	1.9
BT40	DBCA2528S-H	●	BT40-MD25F-95	●	28	38	198	103	63	25	1	0.3	0.3
	DBCA2528S-H	●	BT40-MD25F-105R	●	28	38	208	103	41	25	2	0.3	0.3
	DBCA3238S-H	●	BT40-MD32F-100	●	38	54	210	110	70	32	1	0.5	0.6
	DBCA3238S-H	●	BT40-MD32F-115R	●	38	54	225	110	46	32	2	0.5	0.6
	DBCA5054S-H	●	BT40-MD50F-105	●	54	74	250	145	73	50	1	1.8	1.9
	DBCA6374S-H	●	BT40-MD63F-64	●	74	100	244	180	37	63	1	3.3	3.5
	DBCA6374S-H	●	BT40-MD63F-110	●	74	100	290	180	83	63	1	3.3	3.5
	DBCA6374S-H	●	BT40-MD63F-135	●	74	100	315	180	108	63	1	3.3	3.5
	DBCA80100S-H	●	BT40-MD80F-100	●	100	130	315	215	73	80	3	7.3	7.6

• In the above table, the Arbor Model No. is an example model no. and able to adjust the depth of boring with a combination of MD arbors and extension bars. For more details, see the MD arbor page.

(Unit : mm)

- DBCA2528S-H: CCMT0602□□
- DBCA3238S-H: CCMT0602□□
- DBCA5054S-H: CCMT09T3□□
- DBCA6374S-H: CCMT1204□□
- DBCA80100S-H: CCMT1204□□



BT-DBCA-H (Helical Type)

New balance cut tool(Helical Type)



MAS 403-BT
C
28
130

Shank Coolant System MIN Range MAX Range Boring

Fig.1

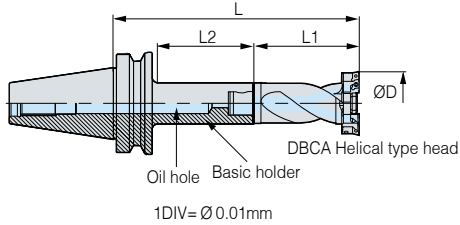
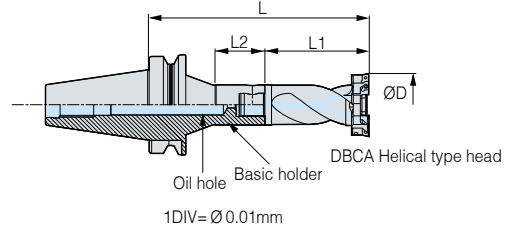
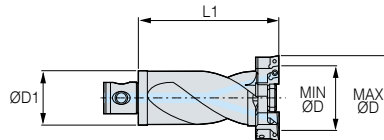

Fig.2



Head



● : Stock

C Internal coolant system is basic

※ Red : Main component Blue : For separate purchase

- For more information on the product features, see 170p.
- For more information on MD arbor, see 153p.
- For more information on the related parts, see 184p.
- For more information on the applicable insert, see 185p.

	Designation				Boring range(ØD)		L	L1	L2	ØD1	Fig.	Head weight(Kg)	Head package weight(Kg)
	Head model no.	Stock	Arbor Model No.	Stock	Min.	Max.							
BT50	DBCA2528S-H	●	BT50-MD25F-105	●	28	38	208	103	62	25	1	0.3	0.3
	DBCA2528S-H	●	BT50-MD25F-120R	●	28	38	223	103	41	25	2	0.3	0.3
	DBCA3238S-H	●	BT50-MD32F-110	●	38	54	220	110	67	32	1	0.5	0.6
	DBCA3238S-H	●	BT50-MD32F-115R	●	38	54	225	110	46	32	2	0.5	0.6
	DBCA3238S-H	●	BT50-MD32F-235R	●	38	54	345	110	115	32	2	0.5	0.6
	DBCA5054S-H	●	BT50-MD50F-125	●	54	74	270	145	82	50	1	1.8	1.9
	DBCA5054S-H	●	BT50-MD50F-225	●	54	74	370	145	182	50	1	1.8	1.9
	DBCA5054S-H	●	BT50-MD50F-250R	●	54	74	395	145	81	50	2	1.8	1.9
	DBCA6374S-H	●	BT50-MD63F-75	●	74	100	255	180	35	63	1	3.3	3.5
	DBCA6374S-H	●	BT50-MD63F-130	●	74	100	310	180	87	63	1	3.3	3.5
	DBCA6374S-H	●	BT50-MD63F-195	●	74	100	375	180	152	63	1	3.3	3.5
	DBCA6374S-H	●	BT50-MD63F-230	●	74	100	410	180	187	63	1	3.3	3.5
	DBCA80100S-H	●	BT50-MD80F-75	●	100	130	290	215	36	80	1	7.3	7.6
	DBCA80100S-H	●	BT50-MD80F-110	●	100	130	325	215	69	80	1	7.3	7.6
	DBCA80100S-H	●	BT50-MD80F-175	●	100	130	390	215	134	80	1	7.3	7.6

• In the above table, the Arbor Model No. is an example model no. and able to adjust the depth of boring with a combination of MD arbors and extension bars. For more details, see the MD arbor page.

(Unit : mm)

- DBCA2528S-H: CCMT0602□□
- DBCA3238S-H: CCMT0602□□
- DBCA5054S-H: CCMT09T3□□
- DBCA6374S-H: CCMT1204□□
- DBCA80100S-H: CCMT1204□□

Chuck

Arbor/Modular

Boring tool

Angular head

CBN/PCD

TAUMAX

Other

1:1 CHAT



HSK-DBCA-H (Helical Type)

New balance cut tool(Helical Type)



Fig.1

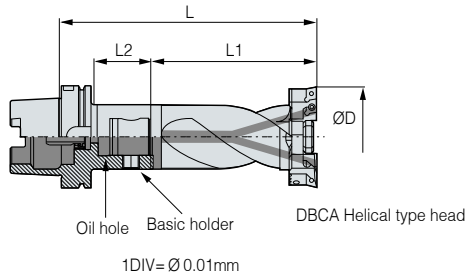
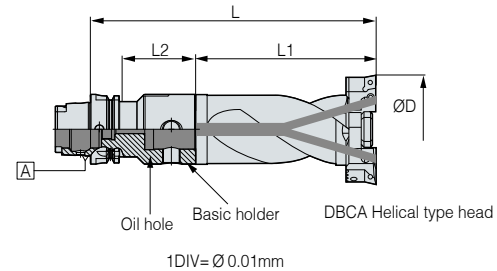
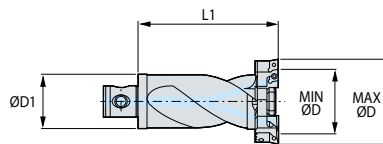

Fig.2



Head



● : Stock

■ Internal coolant system is optional

※ Red : Main component Blue : For separate purchase

• For more information on the product features, see [170p](#).

• For more information on MD arbor, see [154p](#).

• For more information on the related parts, see [184p](#).

• For more information on the applicable insert, see [185p](#).

	Designation				Boring range(ØD)		L	L1	L2	ØD1	Fig.	Head weight(Kg)	Head package weight(Kg)
	Head model no.	Stock	Arbor Model No.	Stock	Min.	Max.							
HSK63A	DBCA2528S-H	●	HSK63A-MD25F-60	●	28	38	163	103	31	25	1	0.3	0.3
	DBCA3238S-H	●	HSK63A-MD32F-65	●	38	54	175	110	36	32	1	0.5	0.6
	DBCA5054S-H	●	HSK63A-MD50F-85	●	54	74	230	145	58	50	1	1.8	1.9
	DBCA6374S-H	●	HSK63A-MD63F-95	●	74	100	275	180	69	63	2	3.3	3.5

• In the above table, the Arbor Model No. is an example model no. and able to adjust the depth of boring with a combination of MD arbors and extension bars. For more details, see the MD arbor page.

(Unit : mm)

- DBCA2528S-H : CCMT0602□□
- DBCA3238S-H : CCMT0602□□
- DBCA5054S-H : CCMT09T3□□
- DBCA6374S-H : CCMT1204□□
- DBCA80100S-H : CCMT1204□□

Accessories

SPARE PART	Type	Accessories
	Images	
Model No.		
HSK63A		HSK63A-CNS





SK-DBCA-H (Helical Type)

New balance cut tool(Helical Type)



DIN69871
-1A/B
C
38
130

Shank Coolant System MIN Range MAX Range Boring

Fig.1

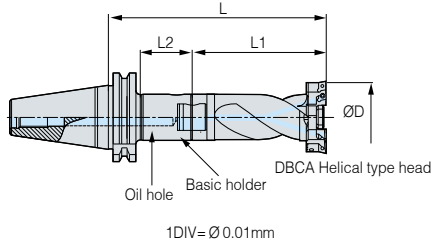

Fig.2

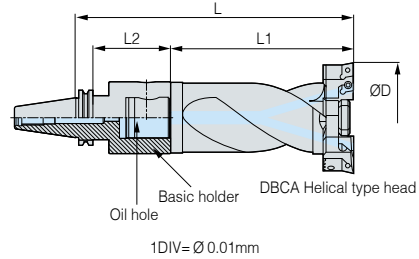
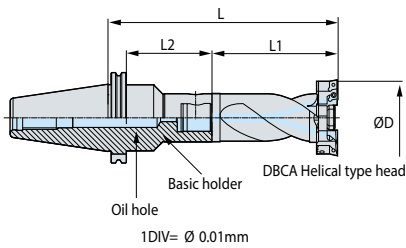
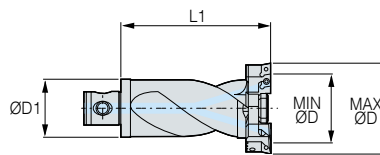

Fig.3



Head



● : Stock

C Internal coolant system is basic

※ Red : Main component Blue : For separate purchase

- For more information on the product features, see 170p.
- For more information on MD arbor, see 155p.
- For more information on the related parts, see 184p.
- For more information on the applicable insert, see 185p.

	Designation				Boring range(ØD)		L	L1	L2	ØD1	Fig.	Head weight(Kg)	Head package weight(Kg)	
	Head model no.	Stock	Arbor Model No.	Stock	Min.	Max.								
07K0	DBCA2528S-H	●	SK40-MD25F-80R	●	28	38	183	103	22	25	3	0.3	0.3	
	DBCA3238S-H	●	SK40-MD32F-115R	●	38	54	225	110	36	32	3	0.5	0.6	
	DBCA5054S-H	●	SK40-MD50F-75	●	54	74	220	145	55	50	1	1.8	1.9	
	DBCA5054S-H	●	SK40-MD50F-100	●	54	74	245	145	80	50	1	1.8	1.9	
	DBCA6374S-H	●	SK40-MD63F-70	●	74	100	250	180	50	63	2	3.3	3.5	
00K50	DBCA2528S-H	●	SK50-MD25F-80R	●	28	38	183	103	22	25	3	0.3	0.3	
	DBCA2528S-H	●	SK50-MD25F-105R	●	28	38	208	103	22	25	3	0.3	0.3	
	DBCA3238S-H	●	SK50-MD32F-110	●	38	54	220	110	87	32	1	0.5	0.6	
	DBCA3238S-H	●	SK50-MD32F-110R	●	38	54	220	110	36	32	3	0.5	0.6	
	DBCA5054S-H	●	SK50-MD50F-125R	●	54	74	270	145	60	50	3	1.8	1.9	
	DBCA5054S-H	●	SK50-MD50F-240R	●	54	74	385	145	125	50	3	1.8	1.9	
	DBCA6374S-H	●	SK50-MD63F-75	●	74	100	255	180	52	63	1	3.3	3.5	
	DBCA6374S-H	●	SK50-MD63F-130	●	74	100	310	180	107	63	1	3.3	3.5	
	DBCA6374S-H	●	SK50-MD63F-230R	●	74	100	410	180	149	63	3	3.3	3.5	
	DBCA80100S-H	●	SK50-MD80F-95	●	100	130	310	215	75	80	1	7.3	7.6	
	DBCA80100S-H	●	SK50-MD80F-150	●	100	130	365	215	129	80	1	7.3	7.6	

In the above table, the Arbor Model No. is an example model no. and able to adjust the depth of boring with a combination of MD arbors and extension bars. For more details, see the MD arbor page.

(Unit : mm)

- DBCA2528S-H : CCMT0602□□
- DBCA3238S-H : CCMT0602□□
- DBCA5054S-H : CCMT09T3□□
- DBCA6374S-H : CCMT1204□□
- DBCA80100S-H : CCMT1204□□

Chuck

Arbor/Modular

Boring tool

Angular head

CBN/PCD

TAUMAX

Other



BT-DBCA-S (Straight Type)

New balance cut tool(Straight Type)



MAS 403-BT
C
28
130
Boring

Shank Coolant System MIN Range MAX Range Boring

Fig.1

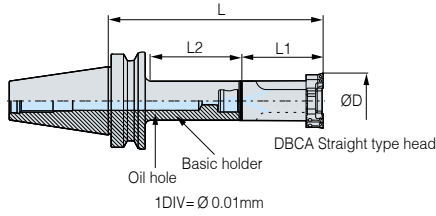

Fig.2

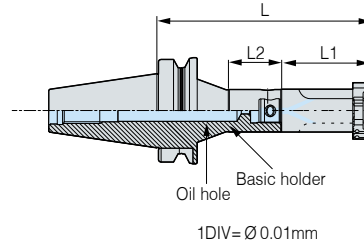
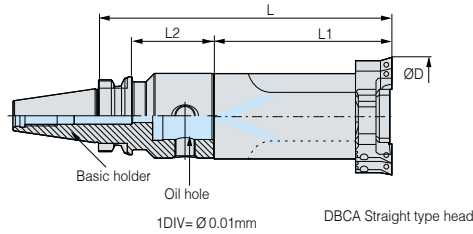
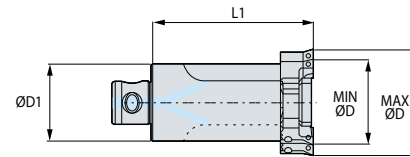

Fig.3



Head



● : Stock

C Internal coolant system is basic

※ Red : Main component Blue : For separate purchase

- For more information on the product features, see 170p.
- For more information on MD arbor, see 152p.
- For more information on the related parts, see 184p.
- For more information on the applicable insert, see 185p.

	Designation				Boring range(ØD)		L	L1	L2	ØD1	Fig.	Head weight(Kg)	Head package weight(Kg)
	Head model no.	Stock	Arbor Model No.	Stock	Min.	Max.							
BT30	DBCA2528S	●	BT30-MD25F-90	●	28	38	150	60	63	25	1	0.2	0.2
	DBCA3238S	●	BT30-MD32F-80	●	38	54	145	65	55	32	1	0.4	0.4
	DBCA5054S	●	BT30-MD50F-70	●	54	74	150	80	48	50	3	1.1	1.1
BT40	DBCA2528S	●	BT40-MD25F-95	●	28	38	155	60	63	25	1	0.2	0.2
	DBCA2528S	●	BT40-MD25F-105R	●	28	38	165	60	41	25	2	0.2	0.2
	DBCA3238S	●	BT40-MD32F-100	●	38	54	165	65	70	32	1	0.4	0.4
	DBCA3238S	●	BT40-MD32F-115R	●	38	54	180	65	46	32	2	0.4	0.4
	DBCA5054S	●	BT40-MD50F-105	●	54	74	185	80	73	50	1	1.1	1.1
	DBCA6374S	●	BT40-MD63F-64	●	74	100	154	90	37	63	1	1.9	2.1
	DBCA6374S	●	BT40-MD63F-110	●	74	100	200	90	83	63	1	1.9	2.1
	DBCA6374S	●	BT40-MD63F-135	●	74	100	225	90	108	63	1	1.9	2.1
	DBCA80100S	●	BT40-MD80F-100	●	100	130	200	100	73	80	3	3.7	3.9

• In the above table, the Arbor Model No. is an example model no. and able to adjust the depth of boring with a combination of MD arbors and extension bars. For more details, see the MD arbor page.

(Unit : mm)

- DBCA2528S : CCMT0602□□
- DBCA3238S : CCMT0602□□
- DBCA5054S : CCMT09T3□□
- DBCA6374S : CCMT1204□□
- DBCA80100S : CCMT1204□□



BT-DBCA-S (Straight Type)

New balance cut tool(Straight Type)

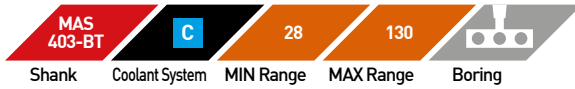

Fig.1

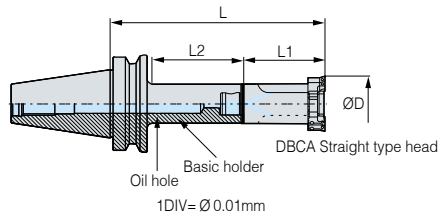
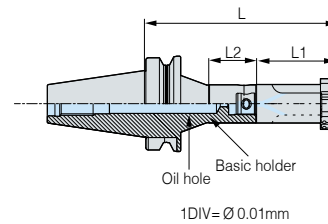
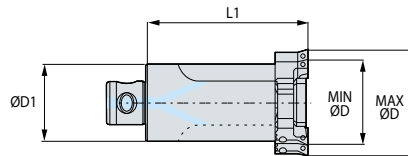

Fig.2



Head



● : Stock

C Internal coolant system is basic

※ **Red** : Main component **Blue** : For separate purchase

- For more information on the product features, see **170p**.
- For more information on MD arbor, see **153p**.
- For more information on the related parts, see **184p**.
- For more information on the applicable insert, see **185p**.

	Designation				Boring range(ØD)		L	L1	L2	ØD1	Fig.	Head weight(Kg)	Head package weight(Kg)
	Head model no.	Stock	Arbor Model No.	Stock	Min.	Max.							
BT50	DBCA2528S	●	BT50-MD25F-105	●	28	38	165	60	62	25	1	0.2	0.2
	DBCA2528S	●	BT50-MD25F-120R	●	28	38	180	60	41	25	2	0.2	0.2
	DBCA3238S	●	BT50-MD32F-110	●	38	54	175	65	67	32	1	0.4	0.4
	DBCA3238S	●	BT50-MD32F-115R	●	38	54	180	65	46	32	2	0.4	0.4
	DBCA3238S	●	BT50-MD32F-235R	●	38	54	300	65	115	32	2	0.4	0.4
	DBCA5054S	●	BT50-MD50F-125	●	54	74	205	80	82	50	1	1.1	1.1
	DBCA5054S	●	BT50-MD50F-225	●	54	74	305	80	182	50	1	1.1	1.1
	DBCA5054S	●	BT50-MD50F-250R	●	54	74	330	80	81	50	2	1.1	1.1
	DBCA6374S	●	BT50-MD63F-75	●	74	100	165	90	35	63	1	1.9	2.1
	DBCA6374S	●	BT50-MD63F-130	●	74	100	220	90	87	63	1	1.9	2.1
	DBCA6374S	●	BT50-MD63F-195	●	74	100	285	90	152	63	1	1.9	2.1
	DBCA6374S	●	BT50-MD63F-230	●	74	100	320	90	187	63	1	1.9	2.1
DBCA80100S	●	BT50-MD80F-75	●	100	130	175	100	36	80	1	3.7	3.9	
DBCA80100S	●	BT50-MD80F-110	●	100	130	210	100	69	80	1	3.7	3.9	
DBCA80100S	●	BT50-MD80F-175	●	100	130	275	100	134	80	1	3.7	3.9	

• In the above table, the Arbor Model No. is an example model no. and able to adjust the depth of boring with a combination of MD arbors and extension bars. For more details, see the MD arbor page.

(Unit : mm)

- DBCA2528S : CCMT0602□□
- DBCA3238S : CCMT0602□□
- DBCA5054S : CCMT09T3□□
- DBCA6374S : CCMT1204□□
- DBCA80100S : CCMT1204□□

Chuck

Arbor/Modular

Boring tool

Angular head

CBN/PCD

TAUMAX

Other

1:1 CHAT



HSK-DBCA-S (Straight Type)

New balance cut tool(Straight Type)



Fig.1

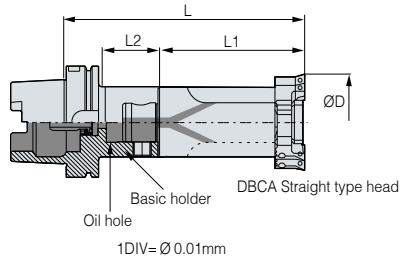
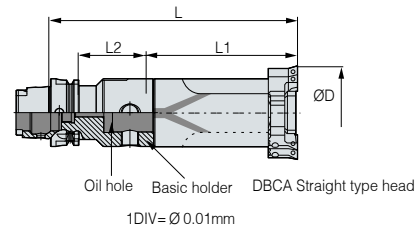
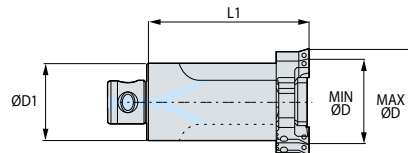

Fig.2



Head



● : Stock

■ Internal coolant system is optional

※ Red : Main component Blue : For separate purchase

- For more information on the product features, see **170p**.
- For more information on MD arbor, see **154p**.
- For more information on the related parts, see **184p**.
- For more information on the applicable insert, see **185p**.

	Designation			Boring range(ØD)		L	L1	L2	ØD1	Fig.	Head weight(Kg)	Head package weight(Kg)	
	Head model no.	Stock	Arbor Model No.	Stock	Min.								Max.
HSK63A	DBCA2528S	●	HSK63A-MD25F-60	●	28	38	120	60	31	25	1	0.3	0.3
	DBCA3238S	●	HSK63A-MD32F-65	●	38	54	130	65	36	32	1	0.5	0.6
	DBCA5054S	●	HSK63A-MD50F-85	●	54	74	165	80	58	50	1	1.8	1.9
	DBCA6374S	●	HSK63A-MD63F-95	●	74	100	185	90	69	63	2	3.3	3.5

• In the above table, the Arbor Model No. is an example model no. and able to adjust the depth of boring with a combination of MD arbors and extension bars. For more details, see the MD arbor page.

(Unit : mm)

- DBCA2528S : CCMT0602□□
- DBCA3238S : CCMT0602□□
- DBCA5054S : CCMT09T3□□
- DBCA6374S : CCMT1204□□
- DBCA80100S : CCMT1204□□

Accessories

SPARE PART	Type	Accessories
	Images	
Model No.		
	HSK63A	HSK63A-CNS





SK-DBCA-S (Straight Type)

New balance cut tool (Straight Type)



Fig.1

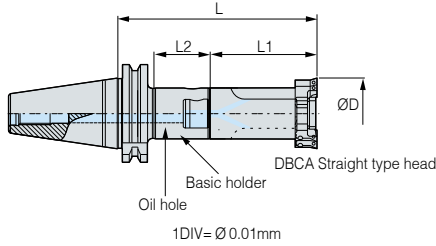

Fig.2

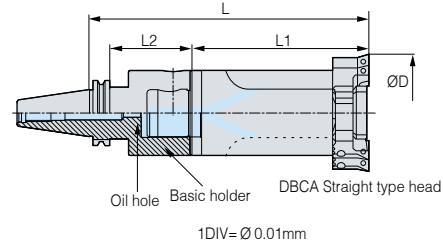
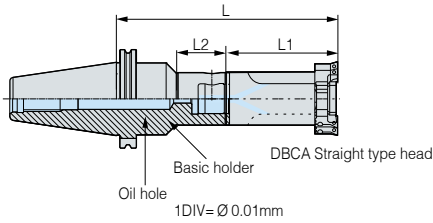
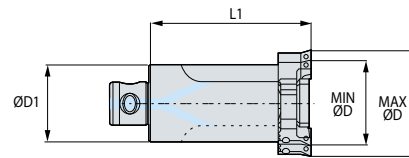

Fig.3



Head



● : Stock

C Internal coolant system is basic

※ Red : Main component Blue : For separate purchase

- For more information on the product features, see **170p**.
- For more information on MD arbor, see **155p**.
- For more information on the related parts, see **184p**.
- For more information on the applicable insert, see **185p**.

	Designation				Boring range(ØD)		L	L1	L2	ØD1	Fig.	Head weight(Kg)	Head package weight(Kg)
	Head model no.	Stock	Arbor Model No.	Stock	Min.	Max.							
SK40	DBCA2528S	●	SK40-MD25F-80R	●	28	38	140	60	22	25	3	0.2	0.2
	DBCA3238S	●	SK40-MD32F-115R	●	38	54	180	65	36	32	3	0.4	0.4
	DBCA5054S	●	SK40-MD50F-75	●	54	74	155	80	55	50	1	1.1	1.1
	DBCA5054S	●	SK40-MD50F-100	●	54	74	180	80	80	50	1	1.1	1.1
	DBCA6374S	●	SK40-MD63F-70	●	74	100	160	90	50	63	2	1.9	2.1
SK50	DBCA2528S	●	SK50-MD25F-80R	●	28	38	140	60	22	25	3	0.2	0.2
	DBCA2528S	●	SK50-MD25F-105R	●	28	38	165	60	22	25	3	0.2	0.2
	DBCA3238S	●	SK50-MD32F-110	●	38	54	175	65	87	32	1	0.4	0.4
	DBCA3238S	●	SK50-MD32F-110R	●	38	54	175	65	36	32	3	0.4	0.4
	DBCA5054S	●	SK50-MD50F-125R	●	54	74	205	80	60	50	3	1.1	1.1
	DBCA5054S	●	SK50-MD50F-240R	●	54	74	320	80	125	50	3	1.1	1.1
	DBCA6374S	●	SK50-MD63F-75	●	74	100	165	90	52	63	1	1.9	2.1
	DBCA6374S	●	SK50-MD63F-130	●	74	100	220	90	107	63	1	1.9	2.1
	DBCA6374S	●	SK50-MD63F-230R	●	74	100	320	90	149	63	3	1.9	2.1
	DBCA80100S	●	SK50-MD80F-95	●	100	130	195	100	75	80	1	3.7	3.9
	DBCA80100S	●	SK50-MD80F-150	●	100	130	250	100	129	80	1	3.7	3.9

In the above table, the Arbor Model No. is an example model no. and able to adjust the depth of boring with a combination of MD arbors and extension bars. For more details, see the MD arbor page.

(Unit : mm)

- DBCA2528S : CCMT0602□□
- DBCA3238S : CCMT0602□□
- DBCA5054S : CCMT09T3□□
- DBCA6374S : CCMT1204□□
- DBCA80100S : CCMT1204□□

Chuck

Arbor/Modular

Boring tool

Angular head

CBN/PCD

TAUMAX

Other



BT-DBC

Balance cut tool(Rough Boring)



MAS 403-BT C 28 175 Boring

Shank Coolant System MIN Range MAX Range Boring

Fig.1

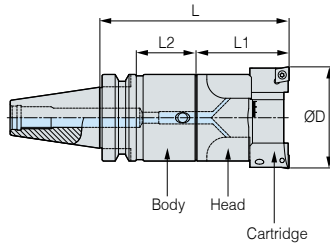

Fig.2

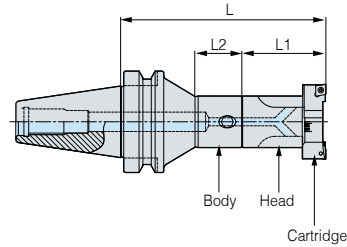
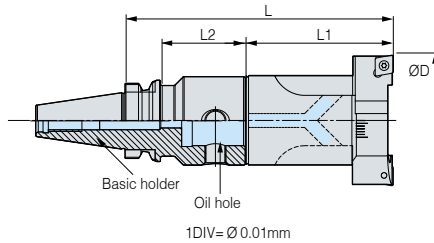
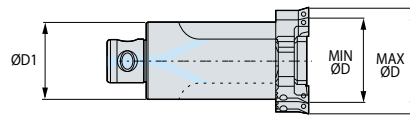

Fig.3



Head



- : Stock
- C** Internal coolant system is basic
- ※ Red : Main component Blue : For separate purchase

- For more information on MD arbor, see **152p**.
- For more information on the related parts, see **184p**.
- For more information on the applicable insert, see **185p**.

	Designation		Boring range(ØD)		L	L1	L2	ØD1	Fig.	Head weight(Kg)	Head package weight(Kg)		
	Head model no.	Stock	Arbor Model No.	Stock								Min.	Max.
BT30	DBC2528S	●	BT30-MD25F-90	●	28	35	150	60	63	25	1	0.3	0.3
	DBC3235S	●	BT30-MD32F-80	●	35	46	145	65	55	32	1	0.4	0.4
	DBC4046S	●	BT30-MD40F-45	●	46	58	115	70	22	40	1	0.6	0.7
	DBC4046S	●	BT30-MD40F-60	●	46	58	130	70	36	40	1	0.6	0.7
	DBC4046S	●	BT30-MD40F-80	●	46	58	150	70	56	40	1	0.6	0.7
	DBC5058S	●	BT30-MD50F-70	●	58	74	150	80	48	50	3	1.1	1.2
BT40	DBC2528S	●	BT40-MD25F-95	●	28	35	155	60	63	25	1	0.3	0.3
	DBC2528S	●	BT40-MD25F-105R	●	28	35	165	60	41	25	2	0.3	0.3
	DBC3235S	●	BT40-MD32F-100	●	35	46	165	65	70	32	1	0.4	0.4
	DBC3235S	●	BT40-MD32F-115R	●	35	46	180	65	46	32	2	0.4	0.4
	DBC4046S	●	BT40-MD40F-60	●	46	58	130	70	31	40	1	0.6	0.7
	DBC4046S	●	BT40-MD40F-110R	●	46	58	180	70	60	40	2	0.6	0.7
	DBC4046S	●	BT40-MD40F-115	●	46	58	185	70	83	40	1	0.6	0.7
	DBC5058S	●	BT40-MD50F-105	●	58	74	185	80	73	50	1	1.1	1.2
	DBC6374S	●	BT40-MD63F-64	●	74	94	154	90	37	63	1	2.0	2.2
	DBC6374S	●	BT40-MD63F-110	●	74	94	200	90	83	63	1	2.0	2.2
	DBC6374S	●	BT40-MD63F-135	●	74	94	225	90	108	63	1	2.0	2.2
	DBC8094S	●	BT40-MD80F-100	●	94	120	200	100	73	80	3	3.5	3.7

• In the above table, the Arbor Model No. is an example model no. and able to adjust the depth of boring with a combination of MD arbors and extension bars. For more details, see the MD arbor page. (Unit : mm)

- DBC2528S : CCMT0602□□
- DBC3235S : CCMT0602□□
- DBC4046S : CCMT09T3□□
- DBC5058S : CCMT09T3□□
- DBC6374S : CCMT1204□□
- DBC8094S : CCMT1204□□



BT-DBC

Balance cut tool(Rough Boring)



MAS 403-BT
C
28
175

Shank Coolant System MIN Range MAX Range Boring

Fig.1

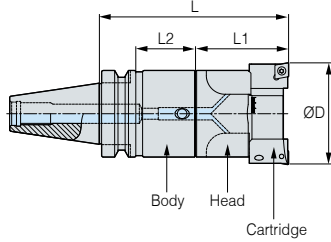
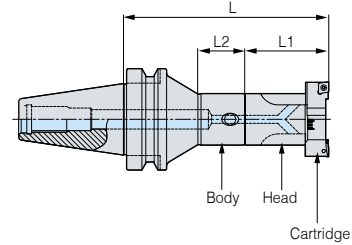
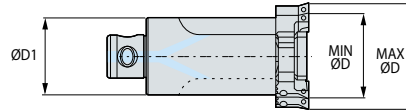

Fig.2



Head



● : Stock

C Internal coolant system is basic

※ Red : Main component Blue : For separate purchase

• For more information on MD arbor, see 153p

• For more information on the related parts, see 184p

• For more information on the applicable insert, see 185p

	Designation				Boring range(ØD)		L	L1	L2	ØD1	Fig.	Head weight(Kg)	Head package weight(Kg)
	Head model no.	Stock	Arbor Model No.	Stock	Min.	Max.							
BT50	DBC2528S	●	BT50-MD25F-105	●	28	35	165	60	62	25	1	0.3	0.3
	DBC2528S	●	BT50-MD25F-120R	●	28	35	185	60	41	25	2	0.3	0.3
	DBC3235S	●	BT50-MD32F-110	●	35	46	175	65	67	32	1	0.4	0.4
	DBC3235S	●	BT50-MD32F-115R	●	35	46	180	65	46	32	2	0.4	0.4
	DBC3235S	●	BT50-MD32F-235R	●	35	46	300	65	115	32	2	0.4	0.4
	DBC4046S	●	BT50-MD40F-60	●	46	58	130	70	21	40	1	0.6	0.7
	DBC4046S	●	BT50-MD40F-195	●	46	58	265	70	152	40	1	0.6	0.7
	DBC4046S	●	BT50-MD40F-230R	●	46	58	300	70	180	40	2	0.6	0.7
	DBC5058S	●	BT50-MD50F-125	●	58	74	205	80	82	50	1	1.1	1.2
	DBC5058S	●	BT50-MD50F-225	●	58	74	305	80	182	50	1	1.1	1.2
	DBC5058S	●	BT50-MD50F-250R	●	58	74	330	80	81	50	2	1.1	1.2
	DBC6374S	●	BT50-MD63F-75	●	74	94	165	90	35	63	1	2.0	2.2
	DBC6374S	●	BT50-MD63F-130	●	74	94	220	90	87	63	1	2.0	2.2
	DBC6374S	●	BT50-MD63F-195	●	74	94	285	90	152	63	1	2.0	2.2
	DBC6374S	●	BT50-MD63F-230	●	74	94	320	90	187	63	1	2.0	2.2
	DBC8094S	●	BT50-MD80F-75	●	94	120	175	100	36	80	1	3.5	3.7
DBC8094S	●	BT50-MD80F-110	●	94	120	210	100	69	80	1	3.5	3.7	
DBC8094S	●	BT50-MD80F-175	●	94	120	275	100	134	80	1	3.5	3.7	
DBC120S	●	BT50-MD80F-175	●	120	175	275	100	134	80	1	4.1	4.4	

In the above table, the Arbor Model No. is an example model no. and able to adjust the depth of boring with a combination of MD arbors and extension bars. For more details, see the MD arbor page.

(Unit : mm)

- DBC2528S : CCMT0602□□
- DBC5058S : CCMT09T3□□
- DBC3235S : CCMT0602□□
- DBC6374S : CCMT1204□□
- DBC4046S : CCMT09T3□□
- DBC8094S : CCMT1204□□

Chuck

Arbor/Modular

Boring tool

Angular head

CBN/PCD

TAUMAX

Other

1:1 CHAT



HSK-DBC

Balance cut tool(Modular Type)



DIN 69893-1
C
28
94

Shank Coolant System MIN Range MAX Range Boring

Fig.1

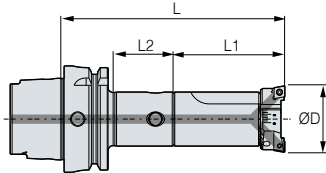
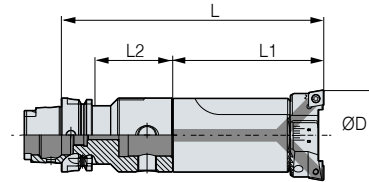
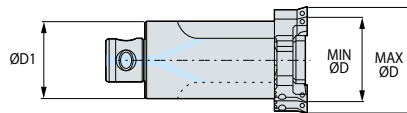

Fig.2



Head



- : Stock
- C Internal coolant system is optional
- ※ Red : Main component Blue : For separate purchase

- For more information on MD arbor, see [154p](#).
- For more information on the related parts, see [184p](#).
- For more information on the applicable insert, see [185p](#).

	Designation				Boring range(ØD)		L	L1	L2	ØD1	Fig.	Head weight(Kg)	Head package weight(Kg)
	Head model no.	Stock	Arbor Model No.	Stock	Min.	Max.							
HSK63A	DBC2528S	●	HSK63A-MD25F-60	●	28	35	120	60	31	25	1	0.3	0.3
	DBC3235S	●	HSK63A-MD32F-65	●	35	46	130	65	36	32	1	0.4	0.4
	DBC4046S	●	HSK63A-MD40F-70	●	46	58	140	70	41	40	1	0.6	0.7
	DBC5058S	●	HSK63A-MD50F-85	●	58	74	165	80	58	50	1	1.1	1.2
	DBC6374S	●	HSK63A-MD63F-95	●	74	94	185	90	69	63	2	2.0	2.2

• In the above table, the Arbor Model No. is an example model no. and able to adjust the depth of boring with a combination of MD arbors and extension bars. For more details, see the MD arbor page. (Unit : mm)

- DBC2528S : CCMT0602□□
- DBC5058S : CCMT09T3□□
- DBC3235S : CCMT0602□□
- DBC6374S : CCMT1204□□
- DBC4046S : CCMT09T3□□
- DBC8094S : CCMT1204□□

Accessories

SPARE PART	Type	Accessories
		Images
	Model No.	
	HSK63A	HSK63A-CNS



SK-DBC

Balance cut tool(Modular Type)



DIN69871
-1A/B
C
28
175

Shank Coolant System MIN Range MAX Range Boring

Fig.1

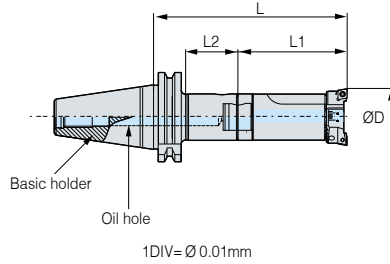

Fig.2

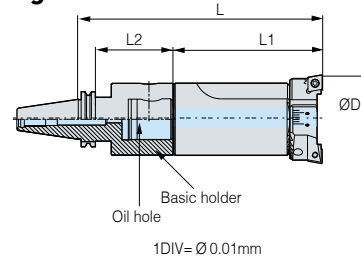
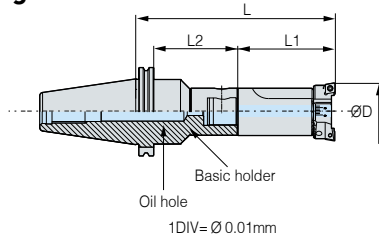
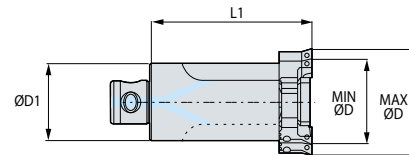

Fig.3



Head



● : Stock

C Internal coolant system is basic

※ Red : Main component Blue : For separate purchase

• For more information on MD arbor, see 155p

• For more information on the related parts, see 184p

• For more information on the applicable insert, see 185p

	Designation				Boring range(ØD)		L	L1	L2	ØD	ØD1	Fig.	Head weight(Kg)	Head package weight(Kg)
	Head model no.	Stock	Arbor Model No.	Stock	Min.	Max.								
SK40	DBC2528S	●	SK40-MD25F-80R	●	28	35	140	60	22	14	25	3	0.3	0.3
	DBC3235S	●	SK40-MD32F-115R	●	35	46	180	65	36	18	32	3	0.4	0.4
	DBC4046S	●	SK40-MD40F-60	●	46	58	130	70	40	22	40	1	0.6	0.7
	DBC4046S	●	SK40-MD40F-100	●	46	58	170	70	80	22	40	1	0.6	0.7
	DBC5058S	●	SK40-MD50F-100	●	58	74	180	80	80	28	50	1	1.1	1.2
	DBC6374S	●	SK40-MD63F-70	●	74	94	160	90	50	36	63	2	2.0	2.2
SK50	DBC2528S	●	SK50-MD25F-80R	●	28	35	140	60	22	14	25	3	0.3	0.3
	DBC2528S	●	SK50-MD25F-105R	●	28	35	165	60	22	14	25	3	0.3	0.3
	DBC3235S	●	SK50-MD32F-110	●	35	46	175	65	87	18	32	1	0.4	0.4
	DBC3235S	●	SK50-MD32F-110R	●	35	46	175	65	36	18	32	3	0.4	0.4
	DBC4046S	●	SK50-MD40F-100	●	46	58	170	70	75	22	40	1	0.6	0.7
	DBC4046S	●	SK50-MD40F-145	●	46	58	215	70	120	22	40	1	0.6	0.7
	DBC4046S	●	SK50-MD40F-220R	●	46	58	290	70	83	22	40	3	0.6	0.7
	DBC5054S	●	SK50-MD50F-125R	●	58	74	205	80	60	28	50	3	1.1	1.2
	DBC5054S	●	SK50-MD50F-240R	●	58	74	320	80	125	28	50	3	1.1	1.2
	DBC6374S	●	SK50-MD63F-75	●	74	94	165	90	52	36	63	1	2.0	2.2
	DBC6374S	●	SK50-MD63F-130	●	74	94	220	90	107	36	63	1	2.0	2.2
	DBC6374S	●	SK50-MD63F-230R	●	74	94	320	90	149	36	63	3	2.0	2.2
	DBC8094S	●	SK50-MD80F-95	●	94	120	195	100	75	45	80	1	3.5	3.7
	DBC8094S	●	SK50-MD80F-150	●	94	120	250	100	129	45	80	1	3.5	3.7
DBC120S	●	SK50-MD80F-150	●	120	175	250	100	129	45	80	1	4.1	4.4	

In the above table, the Arbor Model No. is an example model no. and able to adjust the depth of boring with a combination of MD arbors and extension bars. For more details, see the MD arbor page.

(Unit : mm)

- DBC2528S : CCMT0602□□
- DBC3235S : CCMT0602□□
- DBC4046S : CCMT09T3□□

- DBC5058S : CCMT09T3□□
- DBC6374S : CCMT1204□□
- DBC8094S : CCMT1204□□

Chuck

Arbor/Modular

Boring tool

Angular head

CBN/PCD

TAUMAX

Other



DBCA/DBC SPARE PART

Balance cut tool related parts



Main components

DBCA-H

SPARE PART	Type	Main components										
		Head	Cover	Guide Pin	Spring pin	Wrench bolt	Wrench	Cartridge	Set screw	Wrench	Clamp screw	Torx wrench
	Images											
	Head Model No.											
	DBCA2528S-H	DBCA2528-H	DBC28-ECC	DBC28-ECG	SP0308	BX0420	LW-3	BCC28-EC(SET)	BT0308	LW-1.5	BFTX02506N	TRX8
	DBCA3238S-H	DBCA3238-H	DBC38-ECC	DBC38-ECG	SP0410	BX0525	LW-4	BCC38-EC(SET)	BT0310	LW-1.5	BFTX02506M	TRX8
	DBCA5054S-H	DBCA5054-H	DBC54-ECC	DBC54-ECG	SP0616	BX0630	LW-5	BCC54-EC(SET)	BT0414	LW-2	BFTX0407N	TRX15
	DBCA6374S-H	DBCA6374-H	DBC74-ECC	DBC74-ECG	SP0818	BX0635	LW-5	BCC74-EC(SET)	BT0520	LW-2.5	BFTX0511N	TRX20
	DBCA80100S-H	DBCA80100-H	DBC100-ECC	DBC100-ECG	SP1020	BX0840	LW-6	BCC100-EC(SET)	BT0625	LW-3	BFTX0511N	TRX20

DBCA-S

SPARE PART	Type	Main components										
		Head	Cover	Guide Pin	Spring pin	Wrench bolt	Wrench	Cartridge	Set screw	Wrench	Clamp screw	Torx wrench
	Images											
	Head Model No.											
	DBCA2528S	DBCA2528	DBC28-ECC	DBC28-ECG	SP0308	BX0420	LW-3	BCC28-EC(SET)	BT0308	LW-1.5	BFTX02506N	TRX8
	DBCA3238S	DBCA3238	DBC38-ECC	DBC38-ECG	SP0410	BX0525	LW-4	BCC38-EC(SET)	BT0310	LW-1.5	BFTX02506M	TRX8
	DBCA5054S	DBCA5054	DBC54-ECC	DBC54-ECG	SP0616	BX0630	LW-5	BCC54-EC(SET)	BT0414	LW-2	BFTX0407N	TRX15
	DBCA6374S	DBCA6374	DBC74-ECC	DBC74-ECG	SP0818	BX0635	LW-5	BCC74-EC(SET)	BT0520	LW-2.5	BFTX0511N	TRX20
	DBCA80100S	DBCA80100	DBC100-ECC	DBC100-ECG	SP1020	BX0840	LW-6	BCC100-EC(SET)	BT0625	LW-3	BFTX0511N	TRX20

DBC

SPARE PART	Type	Main components								
		Head	Spring pin	Wrench bolt	Wrench	Cartridge	Set screw	Wrench	Clamp screw	Torx wrench
	Images									
	Head Model No.									
	DBC2528S	DBC2528	SP0308	BX0416	LW-3	BCC28(SET)	BT0306	LW-1.5	FTKA02565	TRX7
	DBC3235S	DBC3235	SP0410	BX0516	LW-4	BCC35(SET)	BT0308	LW-1.5	FTKA02565	TRX7
	DBC4046S	DBC4046	SP0516	BX0620	LW-5	BCC46(SET)	BT0408	LW-2	FTNA0408	TRX15
	DBC5058S	DBC5058	SP0616	BX0620	LW-5	BCC58(SET)	BT0412	LW-2	FTNA0408	TRX15
	DBC6374S	DBC6374	SP0818	BX0830	LW-6	BCC74(SET)	BT0516	LW-2.5	BFTX0511N	TRX20
	DBC8094S	DBC8094	SP1020	BX1035	LW-8	BCC94(SET)	BT0620	LW-3	BFTX0511N	TRX20
	DBC120S	DBC120N	SP1020	BX0830	LW-6	BCC120(SET)	BT0830	LW-4	BFTX0511N	TRX20



DBCA/DBC Insert

Balance cut tool insert



Accessories

INSERT	Insert	Grade				Workpiece	Cutting	Maker
	Coated	AC810P	AC820P		Steel	General	Sumitomo	
	Coated	AC8015P	AC8020P	AC8025P	Steel			
	Coated	AC630M	AC6020M	AC6030M	Stainless Steel			
	Coated	T1500A			Steel/Stainless Steel	Finishing	Korloy	
	Coated	NC3215	NC3120		Steel	General		
	Coated	NC6310	NC6315		Cast iron			
	Coated	PC9030	NC9115	NC9125	Stainless Steel	Finishing to Midium		
	Coated	AC5015S	AC5025S		HRSA/Stainless Steel	General	Sumitomo	
	Cermet	T1500A	T2500Z		Steel/Stainless Steel	General		
	Coated	PC5300	PC8110	PC8115	Stainless Steel	General	Korloy	
	W.C	H01			Aluminum/Copper	Finishing to General		
	Coated	AC8015P			Steel	General	Sumitomo	
	Coated	AC8025P			Steel			
	Coated	AC4015K			Cast iron			
	Coated	AC630M	AC6020M	AC6030M	Stainless Steel	Finishing	Korloy	
	Coated	T1500A	T2500Z		Steel			
	Coated	NC3215	NC3120		Steel			
	Coated	NC6310	NC6315		Cast iron			
	Coated	PC9030	NC9115	NC9125	Stainless Steel	General		
	Coated	AC5015S			HRSA/Stainless Steel	General	Sumitomo	
	Cermet	T1500A			Steel/Stainless Steel	Finishing		
	W.C	H1			Aluminum/Copper	Finishing to General	Korloy	
	Coated	PC9030	PC8110	PC8115	Stainless Steel	General		
	W.C	H01			Aluminum/Copper	Finishing to General		
	Coated	AC8025P			Steel	General	Sumitomo	
	Cermet	T1500A			Steel/Stainless Steel	Finishing		
	Coated	NC3215	NC3120		Steel	General	Korloy	
	Coated	NC6310	NC6315		Cast iron			
	Coated	PC9030	PC5300	PC5400	Stainless Steel			
	W.C	H01			Aluminum/Copper	Finishing to General	Korloy	

- There are a range of grades and chip breakers to choose from according to usage.
- The cartridge for CNMG1204□□ is different from the cartridge for CCMT1204□□ in terms of Model No.

Chuck

Arbor/Modular

Boring tool

Angular head

CBN/PCD

TAUMAX

Other

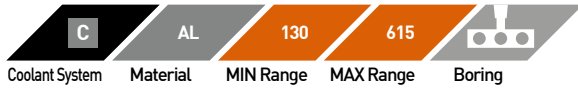

Features

- Convenience in use simultaneously (available both inside and outside)
- Broad boring diameter and range
- Rough / Finishing boring with replaceable cartridge and common rail
- Boring range for outer diameter : $\varnothing 0 \sim \varnothing 395$
- Boring range for inner diameter : $\varnothing 130 \sim \varnothing 631$

NAMING	BODY			HEAD SET		
	BT50	FMC40	50	TBC	130	A
	Spindle	Facemill arbor	length	Balance cut tool	Minimum Boring Range	Advance



Main Features

Reinforced rigidity

50% less moment strain (versus the conventional product of DINE)

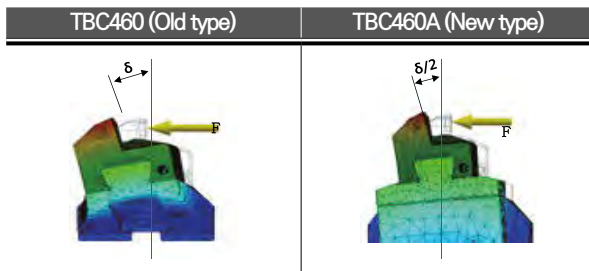

Lightweight design (HEAD SET)

BCC(Cartridge)+DBR(Bridge)+DBB(Rail)



TBC130A	TBC175A	TBC220A	TBC265A
4.2Kg	5.6Kg	6.6Kg	7.5Kg
TBC310A	TBC385A	TBC460A	TBC535A
9.6Kg	11.7Kg	14.1Kg	16.5Kg

Application

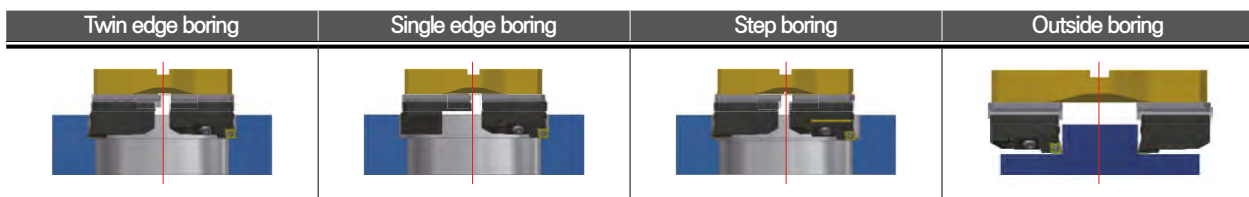

Performance Test

Product	Workpiece		Boring diameter (Depth of cutting)	Results
	Product name	Material	mm	Machining
Conventional tool of DINE	Housing	Cast Iron	$\varnothing 465$ (Rd=7)	<ul style="list-style-type: none"> • Vibration occurred • Insert damaged in the machining process • Scratched surface of workpieces
TBC460A Applicable insert CNMG19	Housing	QT400	$\varnothing 508 \sim 527$ (Rd=10)	<ul style="list-style-type: none"> • No chattering • No vibration found • Goal of accuracy achieved • Normal chip discharged

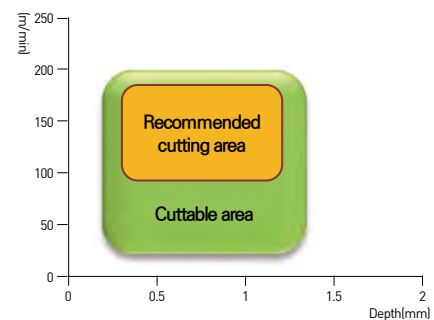



TBCA

Wide Diameter Boring system

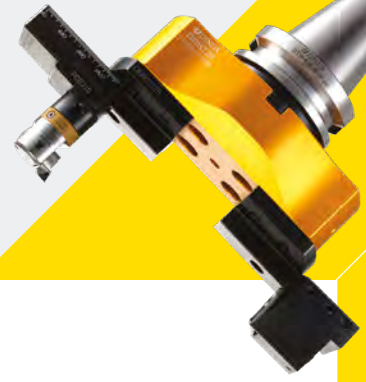

Chuck

Arbor/Modular

Boring tool

Angular head

CBN/PCD

TAUMAX

Other

Convenience

- Inner boring and outer boring can be performed by easily changing the cartridge direction
- With the scale marking on the rail, the boring diameter can be set easily

Inner boring



Outer boring

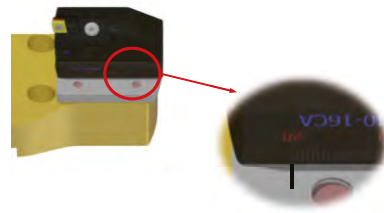

Boring System Map

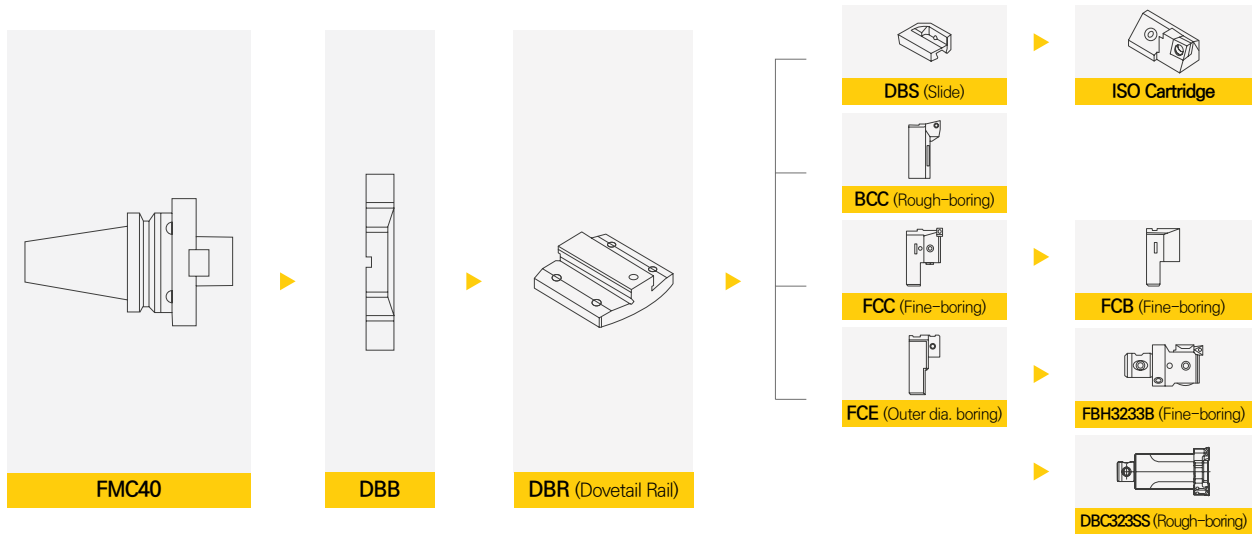

Wide compatibility

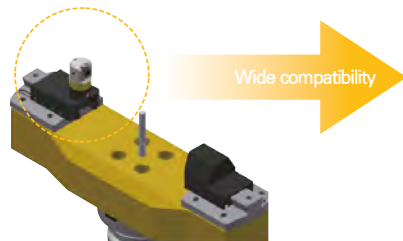

Workpiece outer dia. boring



Workpiece outer dia. boring

	Images	List of clamping parts	Cutting type
Outer dia. boring		FBH3233B+FCE310+FCB310	Finishing boring
		DBC3235S+FCE310+FCB310	Rough boring
Inner dia. boring		DBS□□-□□CA+ISO Cartridge L -type	Rough boring
		FCC310 + FCB310	Finishing boring
		BCC1354	Rough boring

- ※ Diameter setting is possible using pins.
- ※ The pin is a separate purchase product.



TBCA

Wide Diameter Boring system



MAS 403-BT	C	AL	130	615	
Shank	Coolant System	Material	MIN Range	MAX Range	Boring

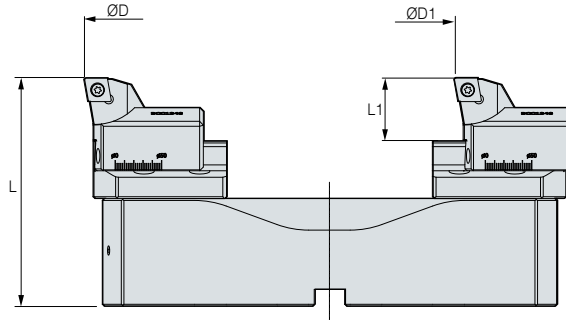

C Internal coolant system is optional

※ Red : Main component

※ The FMC Arbor are sold individually

• For more information on the product features, see **186p**.

• For more information on FMC arbor, see **146p**.

Twin Edge Boring for Roughing						L1	Kg
TBC Head set (Bridge+Rail+BCC Cartridge)	L	Boring range					
		ØD (INSIDE)		ØD1 (OUTSIDE)			
		Min.	Max.	Min.	Max.		
TBC130A(DBB130+DBR130+BCC1348(SET))	108	130	180	0	34	34	4.2
TBC130A(DBB130+DBR130+BCC1348(SET))	113	175	225	25	75	34	5.6
TBC130A(DBB130+DBR130+BCC1348(SET))	118	220	270	15	65	34	6.6
TBC130A(DBB130+DBR130+BCC1348(SET))	123	265	315	61	111	34	7.5
TBC130A(DBB130+DBR130+BCC1354(SET))	128	310	390	10	90	34	9.6
TBC130A(DBB130+DBR130+BCC1354(SET))	133	385	465	85	165	34	11.7
TBC130A(DBB130+DBR130+BCC1354(SET))	138	460	540	160	240	34	14.1
TBC130A(DBB130+DBR130+BCC1354(SET))	143	535	615	235	315	34	16.5

(Unit : mm)

Main components				Accessories	
Head set	Bridge	Rail	Cartridge	Arbor	Pin
TBC130A	DBB130	DBR130	BCC1348(SET)	BT50-FMC40-50	PIN1080
TBC175A	DBB175	DBR175	BCC1348(SET)	BT50-FMC40-50	PIN1080
TBC220A	DBB220	DBR07015	BCC1348(SET)	BT50-FMC40-50	PIN1080
TBC265A	DBB265	DBR07015	BCC1348(SET)	BT50-FMC40-50	PIN1080
TBC310A	DBB310	DBR10015	BCC1354(SET)	BT50-FMC40-50	PIN1080
TBC385A	DBB385	DBR10015	BCC1354(SET)	BT50-FMC40-50	PIN1080
TBC460A	DBB460	DBR10015	BCC1354(SET)	BT50-FMC40-50	PIN1080
TBC535A	DBB535	DBR10015	BCC1354(SET)	BT50-FMC40-50	PIN1080

※ Inserts are purchased separately.



TBCA

Wide Diameter Boring system

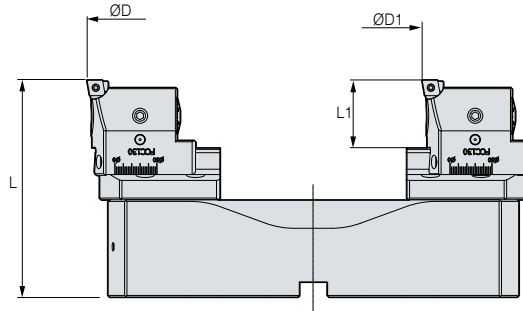
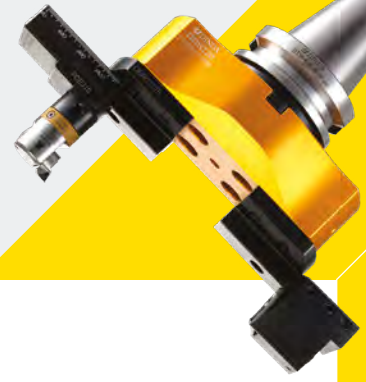

C Internal coolant system is optional

※ Red : Main component Blue : For separate purchase

※ The FMC Arbor are sold individually

• For more information on the product features, see **186p**

• For more information on FMC arbor, see **146p**

Single Edge Boring for Finishing						L1	Kg
TBC Head set <i>(Bridge+Rail For separate purchase)</i>	L	Boring range					
		ØD (INSIDE)		ØD1 (OUTSIDE)			
		Min.	Max.	Min.	Max.		
TBC130A(DBB130+DBR130+FCC130+FCB130+FBB130-□○○)	115	130	180	0	34	41	4.4
TBC175A(DBB175+DBR175+FCC130+FCB130+FBB130-□○○)	120	175	225	25	75	41	5.8
TBC220A(DBB220+DBR07015+FCC130+FCB130+FBB130-□○○)	125	220	270	15	65	41	6.9
TBC265A(DBB265+DBR07015+FCC130+FCB130+FBB130-□○○)	130	265	315	61	111	41	7.9
TBC310A(DBB310+DBR10015+FCC310+FCB310+FBB130-□○○)	135	310	390	10	90	41	10
TBC385A(DBB385+DBR10015+FCC310+FCB310+FBB130-□○○)	140	385	465	85	165	41	12.1
TBC460A(DBB460+DBR10015+FCC310+FCB310+FBB130-□○○)	145	460	540	160	240	41	14.7
TBC535A(DBB535+DBR10015+FCC310+FCB310+FBB130-□○○)	150	535	615	235	315	41	16.9

※ The drawings are for understanding the internal/external diameter processing and may differ from the actual product.

(Unit : mm)

Main components			Accessories				
Head set	Bridge	Rail	Cartridge	Bite	Balance block	Arbor	Pin
TBC130A	DBB130	DBR130	FCC130	FBB130-□○○	FCB130	BT50-FMC40-50	PIN1080
TBC175A	DBB175	DBR175	FCC130	FBB130-□○○	FCB130	BT50-FMC40-50	PIN1080
TBC220A	DBB220	DBR07015	FCC130	FBB130-□○○	FCB130	BT50-FMC40-50	PIN1080
TBC265A	DBB265	DBR07015	FCC130	FBB130-□○○	FCB130	BT50-FMC40-50	PIN1080
TBC310A	DBB310	DBR10015	FCC310	FBB130-□○○	FCB310	BT50-FMC40-50	PIN1080
TBC385A	DBB385	DBR10015	FCC310	FBB130-□○○	FCB310	BT50-FMC40-50	PIN1080
TBC460A	DBB460	DBR10015	FCC310	FBB130-□○○	FCB310	BT50-FMC40-50	PIN1080
TBC535A	DBB535	DBR10015	FCC310	FBB130-□○○	FCB310	BT50-FMC40-50	PIN1080

1:1 CHAT



TBCA

Wide Diameter Boring system

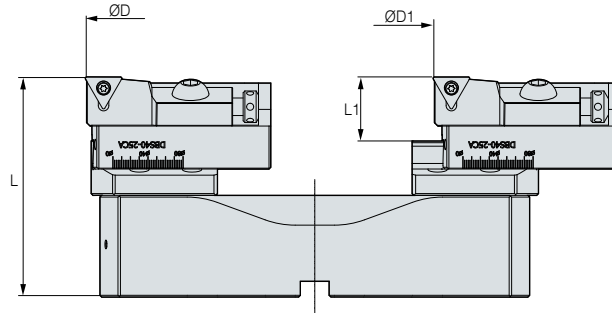
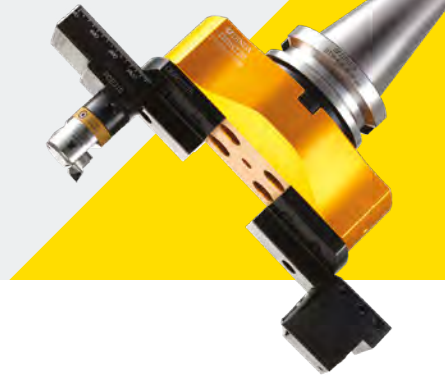

C Internal coolant system is optional

※ Red : Main component Blue : For separate purchase

※ The FMC Arbor are sold individually

• For more information on the product features, see **186p**.

• For more information on FMC arbor, see **146p**.

Step Boring for Roughing						L1	Package weight (Kg)
TBC Head set (Bridge+Rail+For separate purchase)	L	Boring range					
		ØD (INSIDE)		ØD1 (OUTSIDE)			
		Min.	Max.	Min.	Max.		
TBC175A(DBB175+DBR175+DBS25-□□CA+ISO CARTRIDGE L-type)	113	175	225	0	58	34	5.6
TBC220A(DBB220+DBR07015+DBS25-□□CA+ISO CARTRIDGE L-type)	118	220	270	14	78	34	6.7
TBC265A(DBB265+DBR07015+DBS25-□□CA+ISO CARTRIDGE L-type)	123	265	315	59	123	34	7.7
TBC310A(DBB310+DBR10015+DBS40-□□CA+ISO CARTRIDGE L-type)	128	310	390	8	157	34	9.8
TBC385A(DBB385+DBR10015+DBS40-□□CA+ISO CARTRIDGE L-type)	133	385	465	83	232	34	11.9
TBC460A(DBB460+DBR10015+DBS40-□□CA+ISO CARTRIDGE L-type)	138	460	540	158	307	34	14.3
TBC535A(DBB535+DBR10015+DBS70-□□CA+ISO CARTRIDGE L-type)	143	535	615	233	382	34	16.7

(Unit : mm)

Main components			Accessories				
Head set	Bridge	Rail	Arbor	Slide	Cartridge	Plate	Pin
TBC175A	DBB175	DBR175	BT50-FMC40-50	DBS25-16CA DBS25-20CA DBS25-25CA	ISO Cartridge	ISO Cartridge Plates	PIN1080
TBC220A	DBB220	DBR07015					
TBC265A	DBB265	DBR07015					
TBC310A	DBB310	DBR10015					
TBC385A	DBB385	DBR10015					
TBC460A	DBB460	DBR10015					
TBC535A	DBB535	DBR10015					

※ Inserts are purchased separately.



TBCA

Wide Diameter Boring system

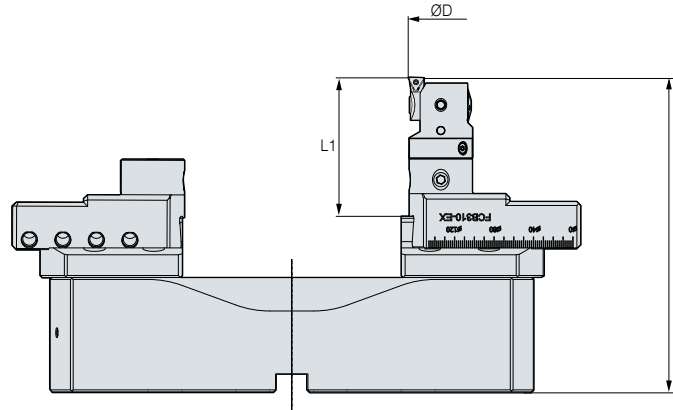
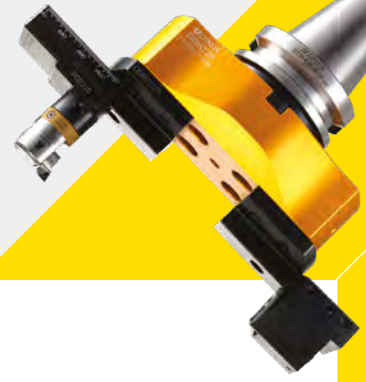

C Internal coolant system is optional

※ Red : Main component Blue : For separate purchase

※ The FMC Arbor are sold individually

• For more information on the product features, see **186p**

• For more information on FMC arbor, see **146p**

Single Edge Boring for Finishing						L1	Package weight (Kg)	
TBC Head set <i>(Bridge+Rail- For separate purchase)</i>		L	Boring range		L1			Package weight (Kg)
			ØD (INSIDE)	ØD1 (OUTSIDE)				
			Min.	Max.	Min.	Max.		
TBC175A(DBB175+DBR175+FCB130+FCE130+FBH3233B+FBB33N)		150	175	235	0	85	5.8	
TBC220A(DBB220+DBR07015+FCB130+FCE130+FBH3233B+FBB33N)		155	220	280	0	135	6.9	
TBC265A(DBB265+DBR07015+FCB130+FCE130+FBH3233B+FBB33N)		160	265	325	36	180	7.9	
TBC310A(DBB310+DBR10015+FCB310+FCE310+FBH3233B+FBB33N)		165	310	400	16	172	10	
TBC385A(DBB385+DBR10015+FCB310+FCE310+FBH3233B+FBB33N)		170	385	475	91	247	12.1	
TBC460A(DBB460+DBR10015+FCB310+FCE310+FBH3233B+FBB33N)		175	460	550	166	322	14.7	
TBC535A(DBB535+DBR10015+FCB310+FCE310+FBH3233B+FBB33N)		180	535	625	241	397	16.9	

(Unit : mm)

Main components			Accessories				
Head set	Bridge	Rail	Arbor	Slide	Balance block	Head	Pin
TBC175A	DBB175	DBR175					
TBC220A	DBB220	DBR07015					
TBC265A	DBB265	DBR07015					
TBC310A	DBB310	DBR10015					
TBC385A	DBB385	DBR10015					
TBC460A	DBB460	DBR10015					
TBC535A	DBB535	DBR10015					
TBC535A	DBB535	DBR10015					



TBC

Balance cut tool for Rough boring

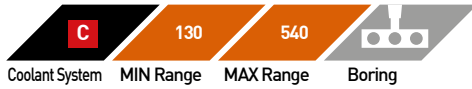

Features

- Broad boring diameter and range
 - Wide Boring Range : $\varnothing 130 \sim \varnothing 540\text{mm}$
- Structurally stable enough to resist cutting load
 - Provides strong cutting performance based on the precision grinding dovetail method
- Can perform fine boring operation by changing boring head cartridges
 - Compatible boring head and rail as they are in the same structure
- Various cartridge tip angles
 - Cartridge fore end angles 15° and 45° selectable

NAMING

HOLDER(option)

BT50

Spindle

FMD50

Basic holder

85

length



Structure and main features of TBC Boring Tool

Names of each part of TBC

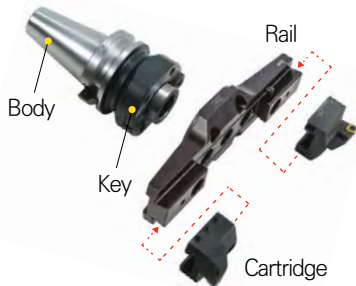

Cartridge : BCC1348
 Insert : CCMT1204□□
 CNMG1204□□



Rail : TBR□□
 Weight reduced and space for chip discharge secured by removing the side part

Boring Range of TBC Boring Tool

Designation	Dia(∅) Boring diameter		Head set	Insert
	Min.	Max.		
TBC130	130	180	TBC130S(TBR130+BCC1348(SET))	CCMT1204□□
TBC175	175	225	TBC175S(TBR175+BCC1348(SET))	CCMT1204□□
TBC220	220	270	TBC220S(TBR220+BCC1348(SET))	CCMT1204□□
TBC265	265	315	TBC265S(TBR265+BCC1348(SET))	CCMT1204□□
TBC310	310	390	TBC310S(TBR310+BCC1354(SET))	CCMT1204□□
TBC385	385	465	TBC385S(TBR385+BCC1354(SET))	CCMT1204□□
TBC460	460	540	TBC460S(TBR460+BCC1354(SET))	CCMT1204□□

(Unit : mm)



TBC

Balance cut tool for Rough boring



Chuck

Arbor/Modular

Boring tool

Angular head

CBN/PCD

TAUMAX

Other

Application example 1 of TBC Boring Tool

Chip shapes by cartridge tip angle diversification



Conventional type

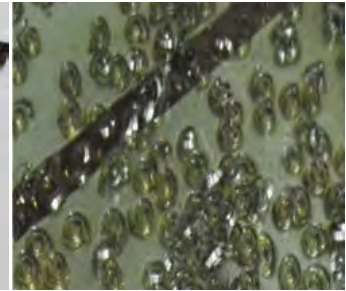

Angle adjustment type



- In the case of conventional type products : thick chips and change by heat
- In the case of "angle adjustment cartridge" : thin chips and no color change

Various cartridges selectable(15°, 45°)

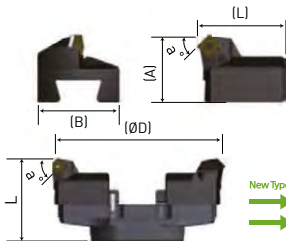

CARTRIDGE	(A)	(B)	(L)	(a°)	Applicable insert
BCC1348	50	60	64.5	1°	CCMT0602□□
BCC1348-SN15	50	60	64.5	15°	SNMG1204□□
BCC1348-SN45	50	60	64.5	45°	SNMG1204□□
BCC1354	50	60	89.5	0°	CCMT0602□□
BCC1354-SN15	50	60	89.5	15°	SNMG1204□□
BCC1354-SN45	50	60	89.5	45°	SNMG1204□□

(Unit : mm)

Application example 2 of Boring Tool

- Equipment : straight type machining center
- Workpiece material : S45C
- Tool used : BT50-FMD50-155+TBC310S
- Insert : CCMT120408
- Cutting conditions : V=200m/min, RPM=163, F=0.1/per knife, d=2mm

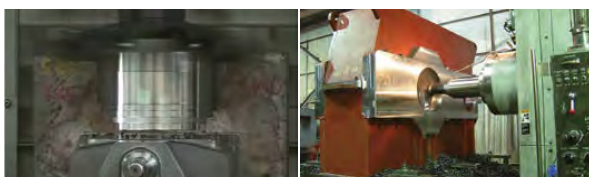

Surface roughness effect

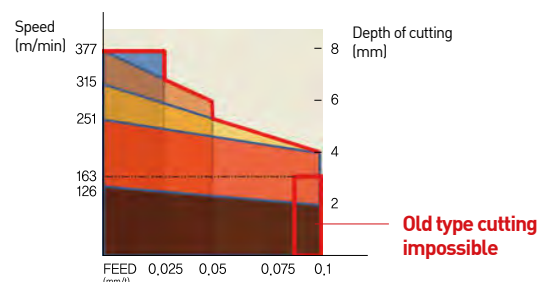



BT-TBC

Balance cut tool for Rough boring



MAS
403-BT
C
130
540
Boring

Shank Coolant System MIN Range MAX Range Boring

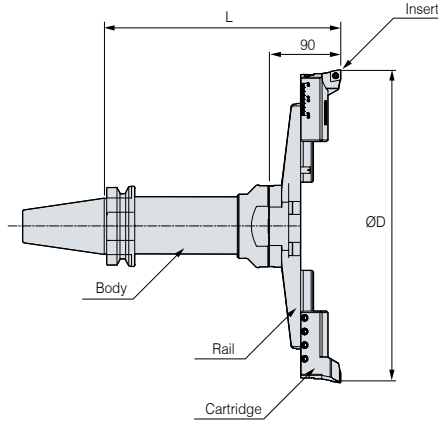

C This product does not support the internal coolant system

※ Red : Main component Blue : For separate purchase

※ The FMC Arbor are sold individually

- For more information on the product features, see **192p**
- For more information on the applicable insert, see **197p**
- For more information on the related parts, see **196p**
- For more information on FMD arbor, see **201p**

	FMD Arbor (Individual order)	Holder weight (Kg)	Rough boring(TBC)				
			TBC Head set (Rail+Cartridge)	L	Boring range(ØD)		Head Weight(Kg)
					Min.	Max.	
BT50	BT50-FMD50-85	5.9	TBC130S(TBR130+BCC1348(SET))	175	130	180	3.2
	BT50-FMD50-155	7.9	TBC130S(TBR130+BCC1348(SET))	245	130	180	3.2
	BT50-FMD50-205	9.7	TBC130S(TBR130+BCC1348(SET))	295	130	180	3.2
	BT50-FMD50-255	13.4	TBC130S(TBR130+BCC1348(SET))	345	130	180	3.2
	BT50-FMD50-85	5.9	TBC175S(TBR175+BCC1348(SET))	175	175	225	3.6
	BT50-FMD50-155	7.9	TBC175S(TBR175+BCC1348(SET))	245	175	225	3.6
	BT50-FMD50-205	9.7	TBC175S(TBR175+BCC1348(SET))	295	175	225	3.6
	BT50-FMD50-255	13.4	TBC175S(TBR175+BCC1348(SET))	345	175	225	3.6
	BT50-FMD50-85	5.9	TBC220S(TBR220+BCC1348(SET))	175	220	270	4
	BT50-FMD50-155	7.9	TBC220S(TBR220+BCC1348(SET))	245	220	270	4
	BT50-FMD50-205	9.7	TBC220S(TBR220+BCC1348(SET))	295	220	270	4
	BT50-FMD50-255	13.4	TBC220S(TBR220+BCC1348(SET))	345	220	270	4
	BT50-FMD50-85	5.9	TBC265S(TBR265+BCC1348(SET))	175	265	315	4.2
	BT50-FMD50-155	7.9	TBC265S(TBR265+BCC1348(SET))	245	265	315	4.2
	BT50-FMD50-205	9.7	TBC265S(TBR265+BCC1348(SET))	295	265	315	4.2
	BT50-FMD50-255	13.4	TBC265S(TBR265+BCC1348(SET))	345	265	315	4.2
	BT50-FMD50-85	5.9	TBC310S(TBR310+BCC1354(SET))	175	310	390	5.2
	BT50-FMD50-155	7.9	TBC310S(TBR310+BCC1354(SET))	245	310	390	5.2
	BT50-FMD50-205	9.7	TBC310S(TBR310+BCC1354(SET))	295	310	390	5.2
	BT50-FMD50-255	13.4	TBC310S(TBR310+BCC1354(SET))	345	310	390	5.2
	BT50-FMD50-85	5.9	TBC385S(TBR385+BCC1354(SET))	175	385	465	5.5
	BT50-FMD50-155	7.9	TBC385S(TBR385+BCC1354(SET))	245	385	465	5.5
	BT50-FMD50-205	9.7	TBC385S(TBR385+BCC1354(SET))	295	385	465	5.5
	BT50-FMD50-255	13.4	TBC385S(TBR385+BCC1354(SET))	345	385	465	5.5
BT50-FMD50-85	5.9	TBC460S(TBR460+BCC1354(SET))	175	460	540	12.5	
BT50-FMD50-155	7.9	TBC460S(TBR460+BCC1354(SET))	245	460	540	12.5	
BT50-FMD50-205	9.7	TBC460S(TBR460+BCC1354(SET))	295	460	540	12.5	
BT50-FMD50-255	13.4	TBC460S(TBR460+BCC1354(SET))	345	460	540	12.5	

(Unit : mm)

1:1 CHAT



TBC HEAD SET

Balance cut tool for Rough boring

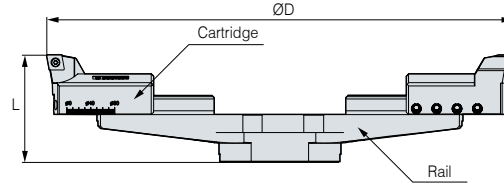

※ If CNMG120400 insert is used, BCN1348, BCN1354 cartridges can be ordered.

TBC HEAD SET

Designation	Head set(Main component)		Boring range(ØD)		L	Kg	Accessories
	Rail	Cartridge	Min.	Max.			Insert
TBC130S	TBR130	BCC1348(SET)	130	180	90	3.5	CCMT1204□□
TBC175S	TBR175	BCC1348(SET)	175	225	90	3.9	CCMT1204□□
TBC220S	TBR220	BCC1348(SET)	220	270	90	4.3	CCMT1204□□
TBC265S	TBR265	BCC1348(SET)	265	315	90	4.5	CCMT1204□□
TBC310S	TBR310	BCC1354(SET)	310	390	90	5.5	CCMT1204□□
TBC385S	TBR385	BCC1354(SET)	385	465	90	5.8	CCMT1204□□
TBC460S	TBR460	BCC1354(SET)	460	540	90	12.8	CCMT1204□□

(Unit : mm)

1:1 CHAT



TBC SPARE PART

Balance cut tool for rough boring related parts



SPARE PART

Type	Main component						
	Rail	Cartridge	Clamp bolt	Hexagonal wrench	Clamp screw	Torx wrench	
Images							
Head Set							
TBC130S	TBR130	BCC1348(SET)	BX0820	BT0645	LW-3 LW-4 LW-6	BFTX0511N	TRX20
TBC175S	TBR175		BX0820	BT0645		BFTX0511N	TRX20
TBC220S	TBR220		BX0820	BT0645		BFTX0511N	TRX20
TBC265S	TBR265		BX0820	BT0645		BFTX0511N	TRX20
TBC310S	TBR310	BCC1354(SET)	BX0820	BT0660	BFTX0511N	TRX20	
TBC385S	TBR385		BX0820	BT0660	BFTX0511N	TRX20	
TBC460S	TBR460		BX0820	BT0660	BFTX0511N	TRX20	



FBC

Balance cut tool for fine boring



C	130	540	
Coolant System	MIN Range	MAX Range	Boring

Features

- Broad boring diameter and range
 - Wide Boring Range : $\varnothing 130 \sim \varnothing 540\text{mm}$
- Structure with fine adjustment function enables high-precision machining
 - $1\text{DIV} = \varnothing 0.01\text{mm}$
- Same body as TBC body for roughing
 - Roughing is possible by changing boring headset set
- ISO standard TIP can be applied to various workpiece materials
 - Applied insert : CCMT09T3 / 1204, TPMT1103



NAMING	HOLDER(option)			HEAD SET	
	BT50 Spindle	FMD50 Basic holder	85 length	FBC Balance cut tool	130S Minimum Boring Range

Structure and main features of FBC Boring Tool

Names of each part of FBC

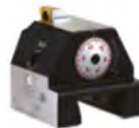
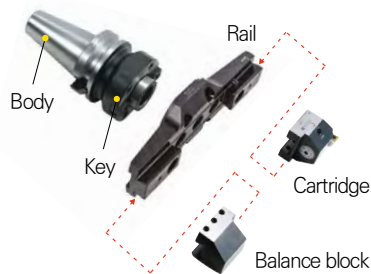

Cartridge : FCC130
Insert : CCGT09T3□□
CCMT1204□□
TPGT1103□□



Balance block : FCB130

Boring range of FBC Boring Tool

Designation	Dia(∅) boring diameter		Head set	Insert
	Min.	Max.		
FBC130	130	180	FBC130S(TBR130+FCC130+FCB130)	FBB130-C09(CCMT09T3□□, CCGT09T3□□) FBB130-C12(CCMT1204□□) FBB130-T11(TPMT1103□□,TPGT1103□□L)
FBC175	175	225	FBC175S(TBR175+FCC130+FCB130)	
FBC220	220	270	FBC220S(TBR220+FCC130+FCB130)	
FBC265	265	315	FBC265S(TBR265+FCC130+FCB130)	
FBC310	310	390	FBC310S(TBR310+FCC310+FCB310)	
FBC385	385	465	FBC385S(TBR385+FCC310+FCB310)	
FBC460	460	540	FBC460S(TBR460+FCC310+FCB310)	

Application example of Special FBC Boring Tool

Material	Cutting speed V	RPM	FEED		Cutting depth ∅ (mm)	Boring diameter ∅ (mm)
			(mm/min)	(mm/rev)		
Aluminium	200	48	5	0.1	0.5	∅1300
	200	48	10	0.1	2	∅1300
	500	120	12	0.1	2	∅1300

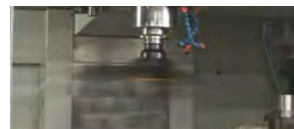



BT-FBC

Balance cut tool for fine boring

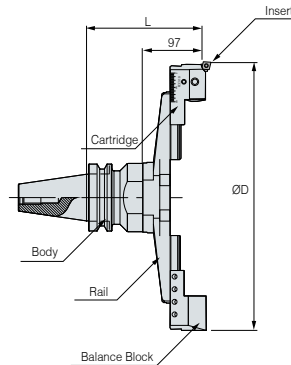
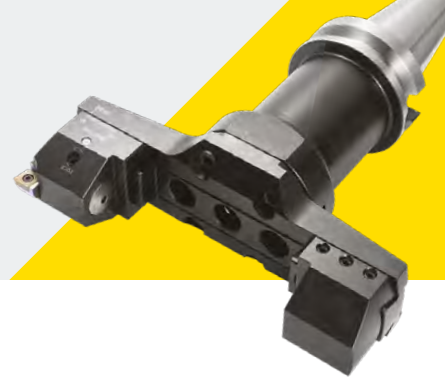

C This product does not support the internal coolant system

※ Red : Main component Blue : For separate purchase

※ The FMC Arbor are sold individually

※ If BB130-C12bite is used, the minimum boring diameter increases by $\varnothing 6.7$ mm

• For more information on the product features, see **197p**.

• For more information on the related parts, see **200p**.

• For more information on FBB bite, see **201p**.

• For more information on FMD arbor, see **201p**.

FMD Arbor (Individual order)	Holder weight (Kg)	Finish boring(FBC)				
		FBC Head set (Rail+Cartridge+Balance block)	L	Kg	Boring range(ØD)	
					Min.	Max.
BT50 BT50-FMD50-85	5.9	FBC130S(TBR130+FCC130+FCB130)	182	3.7	130	180
BT50-FMD50-155	7.9	FBC130S(TBR130+FCC130+FCB130)	252	3.7	130	180
BT50-FMD50-205	9.7	FBC130S(TBR130+FCC130+FCB130)	302	3.7	130	180
BT50-FMD50-255	13.4	FBC130S(TBR130+FCC130+FCB130)	352	3.7	130	180
BT50-FMD50-85	5.9	FBC175S(TBR175+FCC130+FCB130)	182	4.1	175	225
BT50-FMD50-155	7.9	FBC175S(TBR175+FCC130+FCB130)	252	4.1	175	225
BT50-FMD50-205	9.7	FBC175S(TBR175+FCC130+FCB130)	302	4.1	175	225
BT50-FMD50-255	13.4	FBC175S(TBR175+FCC130+FCB130)	352	4.1	175	225
BT50-FMD50-85	5.9	FBC220S(TBR220+FCC130+FCB130)	182	4.5	220	270
BT50-FMD50-155	7.9	FBC220S(TBR220+FCC130+FCB130)	252	4.5	220	270
BT50-FMD50-205	9.7	FBC220S(TBR220+FCC130+FCB130)	302	4.5	220	270
BT50-FMD50-255	13.4	FBC220S(TBR220+FCC130+FCB130)	352	4.5	220	270
BT50-FMD50-85	5.9	FBC265S(TBR265+FCC130+FCB130)	182	4.7	265	315
BT50-FMD50-155	7.9	FBC265S(TBR265+FCC130+FCB130)	252	4.7	265	315
BT50-FMD50-205	9.7	FBC265S(TBR265+FCC130+FCB130)	302	4.7	265	315
BT50-FMD50-255	13.4	FBC265S(TBR265+FCC130+FCB130)	352	4.7	265	315
BT50-FMD50-85	5.9	FBC310S(TBR310+FCC310+FCB310)	182	5.5	310	390
BT50-FMD50-155	7.9	FBC310S(TBR310+FCC310+FCB310)	252	5.5	310	390
BT50-FMD50-205	9.7	FBC310S(TBR310+FCC310+FCB310)	302	5.5	310	390
BT50-FMD50-255	13.4	FBC310S(TBR310+FCC310+FCB310)	352	5.5	310	390
BT50-FMD50-85	5.9	FBC385S(TBR385+FCC310+FCB310)	182	5.8	385	465
BT50-FMD50-155	7.9	FBC385S(TBR385+FCC310+FCB310)	252	5.8	385	465
BT50-FMD50-205	9.7	FBC385S(TBR385+FCC310+FCB310)	302	5.8	385	465
BT50-FMD50-255	13.4	FBC385S(TBR385+FCC310+FCB310)	352	5.8	385	465
BT50-FMD50-85	5.9	FBC460S(TBR460+FCC310+FCB310)	182	12.8	460	540
BT50-FMD50-155	7.9	FBC460S(TBR460+FCC310+FCB310)	252	12.8	460	540
BT50-FMD50-205	9.7	FBC460S(TBR460+FCC310+FCB310)	302	12.8	460	540
BT50-FMD50-255	13.4	FBC460S(TBR460+FCC310+FCB310)	352	12.8	460	540

※ Bite (Insert)

FBB130-CC09 (CCMT09T3□□, CCGT09T3□□) / FBB130-C12 (CCMT1204□□) /
FBB130-T11 (TPMT1103□□, TPGT1103□□)

(Unit : mm)

1:1 CHAT



FBC HEAD SET

Balance cut tool for fine boring

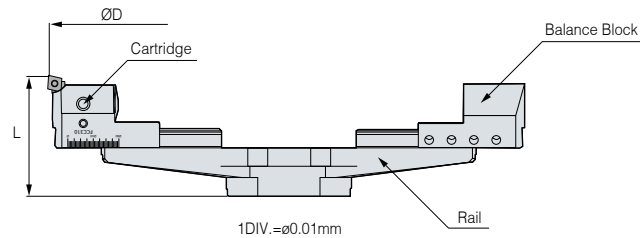

	Head set(Main component)			Boring range(ØD)		L	Package weight(Kg)	Accessories
	Designation	Rail	Cartridge	Balance block	Min.			Max.
FBC HEAD SET	FBC130S	TBR130	FCC130	FCB130	130	180	97	FBB130-C09 FBB130-C12 FBB130-T11
	FBC175S	TBR175	FCC130	FCB130	175	225	97	
	FBC220S	TBR220	FCC130	FCB130	220	270	97	
	FBC265S	TBR265	FCC130	FCB130	265	315	97	
	FBC310S	TBR310	FCC310	FCB310	310	390	97	
	FBC385S	TBR385	FCC310	FCB310	385	465	97	
	FBC460S	TBR460	FCC310	FCB310	460	540	97	

(Unit : mm)

1:1 CHAT



FBC SPARE PART

Balance cut tool for fine boring related parts

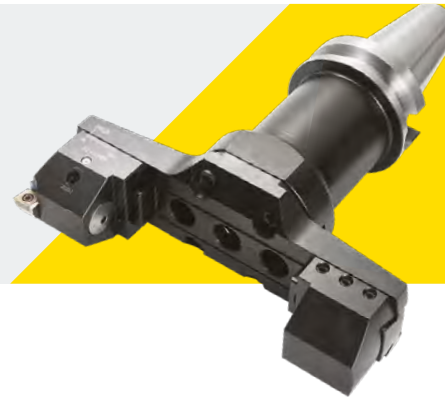

	Type	Main components					Accessories	
		Rail	Cartridge	Balance block	Clamp bolt	Hexagonal wrench	Bite	
SPARE PART	Images							
	Head Set							
	FBC130S	TBR130	FCC130	FCB130	BTF0810 BTF0814	BT0645	LW-3 LW-4	FBB130-C09 FBB130-C12 FBB130-T11
	FBC175S	TBR175						
	FBC220S	TBR220						
	FBC265S	TBR265	FCC310	FCB310	BT0660			
	FBC310S	TBR310						
	FBC385S	TBR385						
FBC460S	TBR460							



FBB Bite

Balance cut tool for fine boring



FBB

Designation	Insert	Insert screw	Clamp bolt
FBB130-C09	CCMT09T3□□, CCGT09T3□□	BFTX0511N	BTF0814
FBB130-C12	CCMT1204□□	BFTX0511N	BTF0814
FBB130-T11	TPMT1103□□, TPGT1103□□	BFTX0511N	BTF0814

Chuck

Arbor/Modular

Boring tool



BT/SK-FMD

Arbor(Basic Holder)

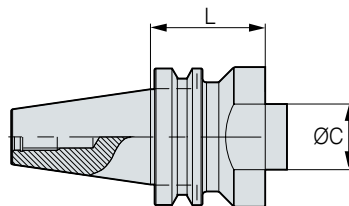

BT50

Designation	L	ØC	Kg
BT50-FMD50-85	85	50	5.9
BT50-FMD50-155	155	50	7.9
BT50-FMD50-205	205	50	9.7
BT50-FMD50-255	255	50	13.4
SK50-FMD50-155	155	50	8
SK50-FMD50-255	255	50	11.2

SK50

(Unit : mm)

Angular head

CBN/PCD

TAUMAX

Other



BT-SMB

Small micro boring bar



MAS 403-BT C Ø8 Ø38 Boring

Shank Coolant System MIN Range MAX Range Boring

Fig.1

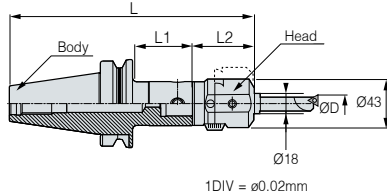
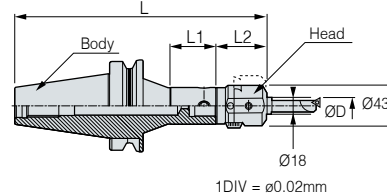
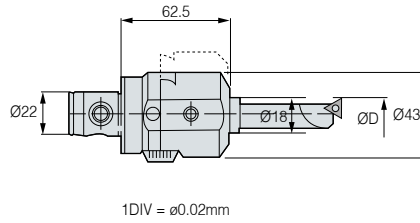

Fig.2



Head



- : Stock
- Adjustment range : 7mm

C This product does not support the internal coolant system

※ Red : Main component Blue : For separate purchase

- For more information on MD arbor, see **152p**.
- For more information on the related parts, see **209p**.
- For more information on BB bite, see **210p**.

	Designation					Boring range(ØD)	L	L1	L2	Fig.	Head Weight(Kg)
	Head model no.	Stock	Arbor Model No.	Stock	BB bite						
BT30	SMB4022	●	BT30-MD40F-45	●	BB18-□(S)	Ø8~Ø38	108	22	62.5	1	0.6
	SMB4022	●	BT30-MD40F-60	●	BB18-□(S)	Ø8~Ø38	123	36	62.5	1	0.6
	SMB4022	●	BT30-MD40F-80	●	BB18-□(S)	Ø8~Ø38	143	56	62.5	1	0.6
BT40	SMB4022	●	BT40-MD40F-60	●	BB18-□(S)	Ø8~Ø38	123	31	62.5	1	0.6
	SMB4022	●	BT40-MD40F-100R	●	BB18-□(S)	Ø8~Ø38	173	60	62.5	2	0.6
	SMB4022	●	BT40-MD40F-115	●	BB18-□(S)	Ø8~Ø38	178	83	62.5	1	0.6
BT50	SMB4022	●	BT50-MD40F-60	●	BB18-□(S)	Ø8~Ø38	123	22	62.5	1	0.6
	SMB4022	●	BT50-MD40F-195	●	BB18-□(S)	Ø8~Ø38	258	152	62.5	1	0.6
	SMB4022	●	BT50-MD40F-230R	●	BB18-□(S)	Ø8~Ø38	293	180	62.5	2	0.6

(Unit : mm)

BB Bite(For SMB)	Designation	Boring range(ØD)		Insert	Screw	Kg
		Min.	Max.			
	BB18-7(S)	8	28	TBGT0601□□L	BFTX0204A	0.1
	BB18-9(S)	10	30	TPGT0802□□L	BFTX0204A	0.1
	BB18-11(S)	12	32	TPGT1103□□L	BFTX0307A	0.1
	BB18-13(S)	14	34	TPGT1103□□L	BFTX0307A	0.1
	BB18-15(S)	16	36	TPGT1103□□L	BFTX0307A	0.2
	BB18-17(S)	18	38	TPGT1103□□L	BFTX0307A	0.2

(Unit : mm)



HSK/SK-SMB

Small micro boring bar



DIN 69893-1	DIN69871 -1A/B	C	Ø8	Ø38	
Shank	Shank	Coolant System	MIN Range	MAX Range	Boring

Fig.1

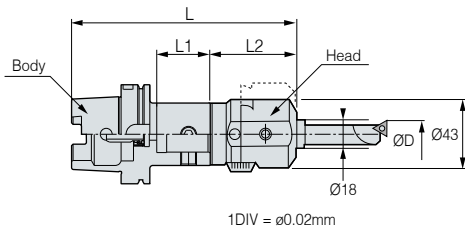

Fig.2

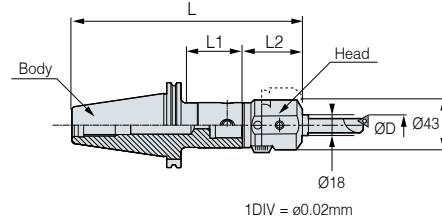
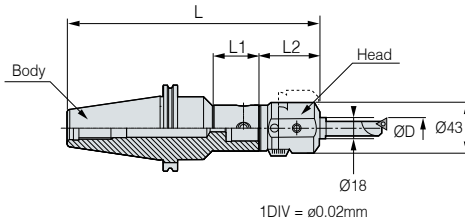
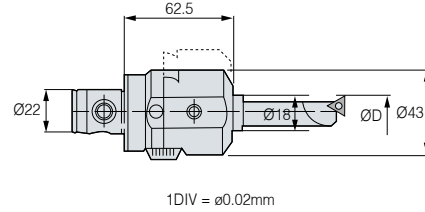

Fig.3



Head



- : Stock
- Adjustment range : 7mm

C This product does not support the internal coolant system

※ **Red** : Main component **Blue** : For separate purchase

- For more information on MD arbor, see **154p**
- For more information on the related parts, see **209p**
- For more information on BB bite, see **210p**

	Designation					Boring range(ØD)	L	L1	L2	Fig.	Head Weight(Kg)
	Head model no.	Stock	Arbor Model No.	Stock	BB bite						
HSK63A	SMB4022	●	HSK63A-MD40F-70	●	BB18-□(S)	Ø8-Ø38	133	41	62.5	1	0.6
SK40	SMB4022	●	SK40-MD40F-60	●	BB18-□(S)	Ø8-Ø38	123	40	62.5	2	0.6
	SMB4022	●	SK40-MD40F-100	●	BB18-□(S)	Ø8-Ø38	163	7	62.5	2	0.6
SK50	SMB4022	●	SK50-MD40F-145	●	BB18-□(S)	Ø8-Ø38	208	120	62.5	2	0.6
	SMB4022	●	SK50-MD40F-220R	●	BB18-□(S)	Ø8-Ø38	283	83	62.5	3	0.6

(Unit : mm)

BB Bite(For SMB)	Designation	Boring range(ØD)		Insert	Screw	Kg
		Min.	Max.			
	BB18-7(S)	8	28	TBGT0601□□L	BFTX0204A	0.1
	BB18-9(S)	10	30	TPGT0802□□L	BFTX0204A	0.1
	BB18-11(S)	12	32	TPGT1103□□L	BFTX0307A	0.1
	BB18-13(S)	14	34	TPGT1103□□L	BFTX0307A	0.1
	BB18-15(S)	16	36	TPGT1103□□L	BFTX0307A	0.2
	BB18-17(S)	18	38	TPGT1103□□L	BFTX0307A	0.2

(Unit : mm)

Chuck

Arbor/Modular

Boring tool

Angular head

CBN/PCD

TAUMAX

Other



BT-KMB

Micro boring



MAS 403-BT C Ø8 Ø165 Boring

Shank Coolant System MIN Range MAX Range Boring

Fig.1

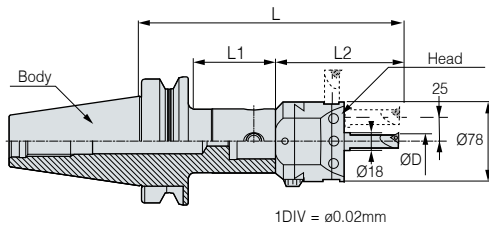

Head

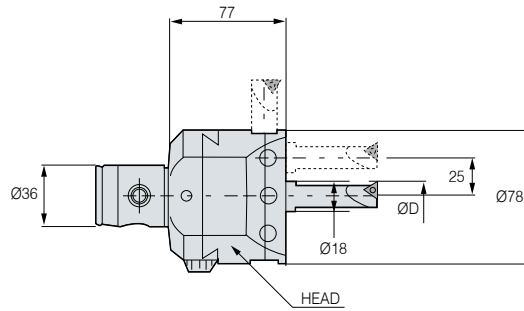

- : Stock
- Adjustment range : 17mm

C This product does not support the internal coolant system

※ Red : Main component Blue : For separate purchase

- For more information on MD arbor, see **152p**
- For more information on the related parts, see **209p**
- For more information on BB bite, see **210p**

	Designation	Designation			Boring range(ØD)			L	L1	L2	Fig.	Head Weight(Kg)	
		Head model no.	Stock	Arbor Model No.	Stock	BB bite	Center hole						Eccentric hole
BT40	KMB6336	●	BT40-MD63F-64	●	BB18-□(S)	Ø8~Ø52	Ø43~Ø101	MAX Ø165	141	37	77	1	2.2
	KMB6336	●	BT40-MD63F-110	●	BB18-□(S)	Ø8~Ø52	Ø43~Ø101	MAX Ø165	187	83	77	1	2.2
	KMB6336	●	BT40-MD63F-135	●	BB18-□(S)	Ø8~Ø52	Ø43~Ø101	MAX Ø165	212	108	77	1	2.2
BT50	KMB6336	●	BT50-MD63F-75	●	BB18-□(S)	Ø8~Ø52	Ø43~Ø101	MAX Ø165	152	35	77	1	2.2
	KMB6336	●	BT50-MD63F-130	●	BB18-□(S)	Ø8~Ø52	Ø43~Ø101	MAX Ø165	207	87	77	1	2.2
	KMB6336	●	BT50-MD63F-195	●	BB18-□(S)	Ø8~Ø52	Ø43~Ø101	MAX Ø165	272	152	77	1	2.2

(Unit : mm)

BB Bite(For KMB)	Designation	Boring range(ØD)				Insert	Screw	Kg
		Center	Eccentric					
	BB18-7(S)	8	42	43	91	TBGT0601□□L	BFTX0204A	0.1
	BB18-9(S)	10	44	45	93	TPGT0802□□L	BFTX0204A	0.1
	BB18-11(S)	12	46	47	95	TPGT1103□□L	BFTX0307A	0.1
	BB18-13(S)	14	48	49	97	TPGT1103□□L	BFTX0307A	0.1
	BB18-15(S)	16	50	51	99	TPGT1103□□L	BFTX0307A	0.2
	BB18-17(S)	18	52	53	101	TPGT1103□□L	BFTX0307A	0.2

(Unit : mm)



HSK/SK-KMB

Micro boring



DIN 69893-1	DIN69871 -1A/B	C	Ø8	Ø165	
Shank	Shank	Coolant System	MIN Range	MAX Range	Boring

Fig.1

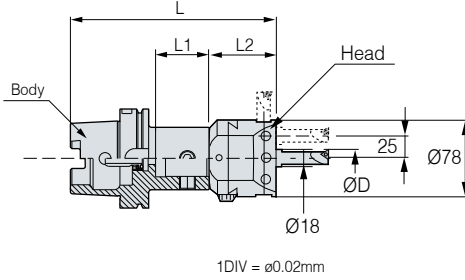

Fig.2

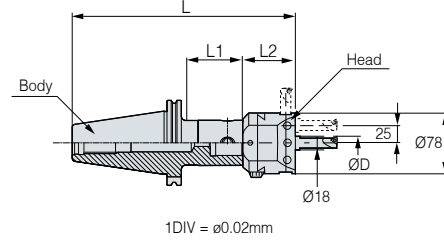
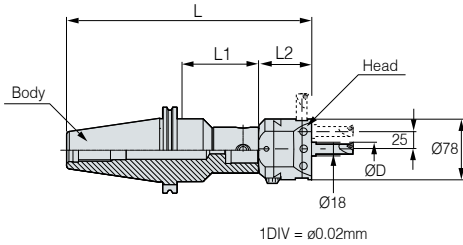
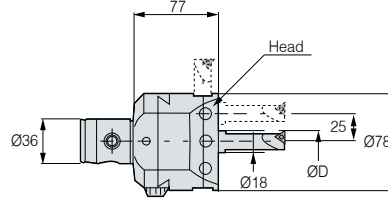

Fig.3



Head



● : Stock

• Adjustment range : 17mm

C This product does not support the internal coolant system

※ **Red** : Main component **Blue** : For separate purchase

• For more information on MD arbor, see **154p**

• For more information on the related parts, see **209p**

• For more information on BB bite, see **210p**

	Designation				Boring range(ØD)			L	L1	L2	Fig.	Head Weight(Kg)	
	Head model no.	Stock	Arbor Model No.	Stock	BB bite	Center hole	Eccentric hole						Side hole
HSK63A	KMB6336	●	HSK63A-MD63F-95	●	BB18-□(S)	Ø8-Ø52	Ø43-Ø101	MAX Ø165	172	69	77	1	2.2
SK40	KMB6336	●	SK40-MD63F-70	●	BB18-□(S)	Ø8-Ø52	Ø43-Ø101	MAX Ø165	147	51	77	2	2.2
SK50	KMB6336	●	SK50-MD63F-130	●	BB18-□(S)	Ø8-Ø52	Ø43-Ø101	MAX Ø165	207	108	77	2	2.2
	KMB6336	●	SK50-MD63F-230R	●	BB18-□(S)	Ø8-Ø52	Ø43-Ø101	MAX Ø165	307	149	77	3	2.2

(Unit : mm)

BB Bite(For KMB)	Designation	Boring range(ØD)				Insert	Screw	Kg
		Center	Eccentric					
	BB18-7(S)	8	42	43	91	TBGT0601□□L	BFTX0204A	0.1
	BB18-9(S)	10	44	45	93	TPGT0802□□L	BFTX0204A	0.1
	BB18-11(S)	12	46	47	95	TPGT1103□□L	BFTX0307A	0.1
	BB18-13(S)	14	48	49	97	TPGT1103□□L	BFTX0307A	0.1
	BB18-15(S)	16	50	51	99	TPGT1103□□L	BFTX0307A	0.2
	BB18-17(S)	18	52	53	101	TPGT1103□□L	BFTX0307A	0.2

(Unit : mm)

1:1 CHAT



BT-SMH

Small micro boring bar

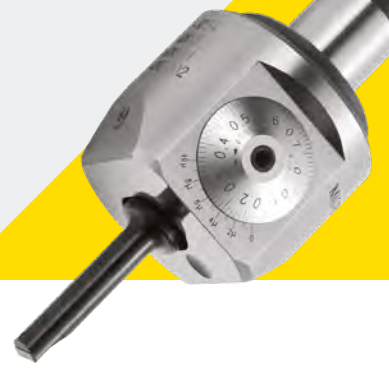

MAS 403-BT C Ø6 Ø34 Boring

Shank Coolant System MIN Range MAX Range Boring

Fig.1

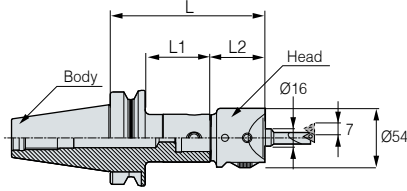
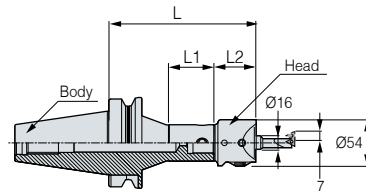
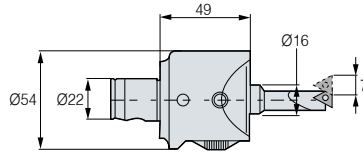

Fig.2



Head



※ 1DIV = ø0.01mm

- : Stock
- Adjustment range : 7mm

C This product does not support the internal coolant system

※ Red : Main component Blue : For separate purchase

- For more information on MD arbor, see **152p**.
- For more information on the related parts, see **209p**.
- For more information on BB bite, see **210p**.

	Designation					Boring range(ØD)	L	L1	L2	Fig.	Head Weight(Kg)
	Head model no.	Stock	Arbor Model No.	Stock	BB bite						
BT30	SMH4022	●	BT30-MD40F-45	●	BB16-□(S)	Ø6~Ø34	94	22	49	1	0.6
	SMH4022	●	BT30-MD40F-60	●	BB16-□(S)	Ø6~Ø34	109	36	49	1	0.6
	SMH4022	●	BT30-MD40F-80	●	BB16-□(S)	Ø6~Ø34	129	56	49	1	0.6
BT40	SMH4022	●	BT40-MD40F-60	●	BB16-□(S)	Ø6~Ø34	109	31	49	1	0.6
	SMH4022	●	BT40-MD40F-100R	●	BB16-□(S)	Ø6~Ø34	159	60	49	2	0.6
	SMH4022	●	BT40-MD40F-115	●	BB16-□(S)	Ø6~Ø34	164	83	49	1	0.6
BT50	SMH4022	●	BT50-MD40F-60	●	BB16-□(S)	Ø6~Ø34	109	22	49	1	0.6
	SMH4022	●	BT50-MD40F-195	●	BB16-□(S)	Ø6~Ø34	244	152	49	1	0.6
	SMH4022	●	BT50-MD40F-230R	●	BB16-□(S)	Ø6~Ø34	279	180	49	2	0.6

(Unit : mm)

BB Bite(For SMH)	Designation	Boring range(ØD)		Insert	Screw	Kg
		Min.	Max.			
	BB16-5(S)	6	20	WBGT0601□□L	BFTX0203A	TRX06
	BB16-7(S)	8	22	TBGT0601□□L	BFTX0204A	TRX06
	BB16-9(S)	10	24	TPGT0802□□L	BFTX0204A	TRX06
	BB16-11(S)	12	26	TPGT1103□□L	BFTX0307A	TRX10
	BB16-15(S)	16	30	TPGT1103□□L	BFTX0307A	TRX10
	BB16-19(S)	20	34	TPGT1604□□L	BFTX0410A	TRX15

※ BB Bites are purchased separately.

(Unit : mm)



HSK/SK-SMH

Small micro boring bar

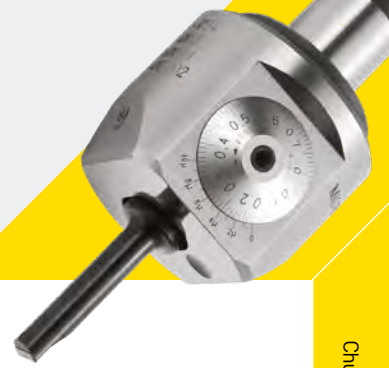

DIN 69893-1	DIN69871 -1A/B	C	Ø6	Ø34	
Shank	Shank	Coolant System	MIN Range	MAX Range	Boring

Fig.1

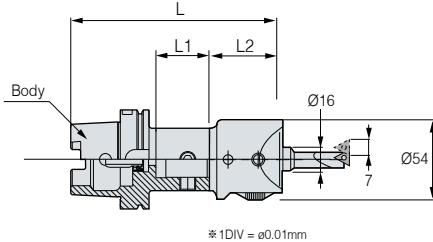

Fig.2

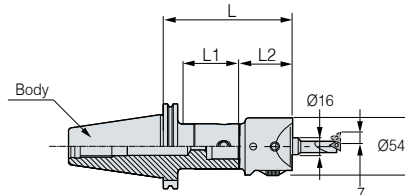
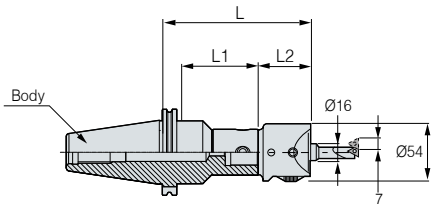
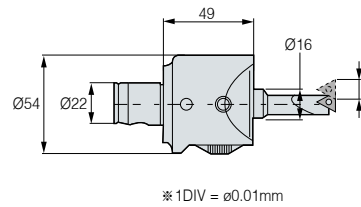

Fig.3



Head



- : Stock
- Adjustment range : 7mm

C This product does not support the internal coolant system

※ **Red** : Main component **Blue** : For separate purchase

- For more information on MD arbor, see **154p**
- For more information on the related parts, see **209p**
- For more information on BB bite, see **210p**

	Designation				Boring range(ØD)	L	L1	L2	Fig.	Head Weight(Kg)	
	Head model no.	Stock	Arbor Model No.	Stock							BB bite
HSK63A	SMH4022	●	HSK63A-MD40F-70	●	BB16-□(S)	Ø6-Ø34	119	41	49	1	0.6
SK40	SMH4022	●	SK40-MD40F-60	●	BB16-□(S)	Ø6-Ø34	109	40	49	2	0.6
	SMH4022	●	SK40-MD40F-100	●	BB16-□(S)	Ø6-Ø34	149	79	49	2	0.6
SK50	SMH4022	●	SK50-MD40F-145	●	BB16-□(S)	Ø6-Ø34	194	120	49	2	0.6
	SMH4022	●	SK50-MD40F-220R	●	BB16-□(S)	Ø6-Ø34	269	83	49	3	0.6

(Unit : mm)

BB Bite(For SMH)	Designation	Boring range(ØD)		Insert	Screw	Kg
		Min.	Max.			
	BB16-5(S)	6	20	WBGT0601□□L	BFTX0203A	TRX06
	BB16-7(S)	8	22	TBGT0601□□L	BFTX0204A	TRX06
	BB16-9(S)	10	24	TPGT0802□□L	BFTX0204A	TRX06
	BB16-11(S)	12	26	TPGT1103□□L	BFTX0307A	TRX10
	BB16-15(S)	16	30	TPGT1604□□L	BFTX0307A	TRX10
	BB16-19(S)	20	34	TPGT1604□□L	BFTX0410A	TRX15

※ BB Bites are purchased separately.

(Unit : mm)

Chuck

Arbor/Modular

Boring tool

Angular head

CBN/PCD

TAUMAX

Other



SMB SPARE PART

Small micro boring bar related parts



• The taper screw is built in the arbor by default.

• For more information on MD arbor, see **152p**.

SPARE PART	Type	Main components			Accessories	
		Boring head	Taper screw	Wrench	Boring bite	MD arbor
	Images					
	Model No.					
	SMB	SMB4022	BTT1013F	LW-2.5	BB18	MD40F

Chuck

Arbor/Modular



KMB SPARE PART

Micro boring related parts



• The taper screw is built in the arbor by default.

• For more information on MD arbor, see **152p**.

SPARE PART	Type	Main components			Accessories	
		Boring head	Taper screw	Wrench	Boring bite	MD arbor
	Images					
	Model No.					
	KMB	KMB6336	BTT1620F	LW-4.0	BB18	MD63F

Boring tool

Angular head



SMH SPARE PART

Micro boring related parts

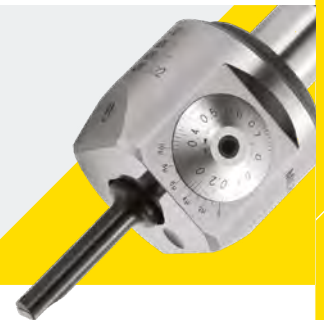

• The taper screw is built in the arbor by default.

• For more information on MD arbor, see **152p**.

SPARE PART	Type	Main components			Accessories	
		Boring head	Taper screw	Wrench	Boring bite	MD arbor
	Images					
	Model No.					
	SMH	SMH4022	BTT1013F	LW-3.0	BB16	MD40F

CBN/PCD

TAUMAX

Other



BB BITE

BB Bite(for SMB, SMH, KMB)



Boring bite : BB type(for SMB)

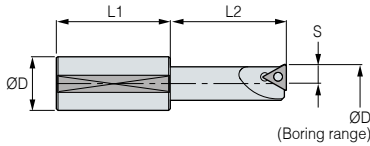

Designation	Boring range(center)		S	øD	L1	L2	Insert	Insert Screw
	Min.	Max.						
BB18 - 7(S)	8	28	3.5	18	30	30	TBGT0601□□□□	BFTX0204A
BB18 - 9(S)	10	30	4.5	18	30	40	TPGT0802□□□□	BFTX0204A
BB18 - 11(S)	12	32	5.5	18	30	45	TPGT1103□□□□	BFTX0307A
BB18 - 13(S)	14	34	6.5	18	40	45	TPGT1103□□□□	BFTX0307A
BB18 - 15(S)	16	36	7.5	18	40	50	TPGT1103□□□□	BFTX0307A
BB18 - 17(S)	18	38	8.5	18	40	50	TPGT1103□□□□	BFTX0307A

(Unit : mm)

Boring bite : BB type(for SMH)

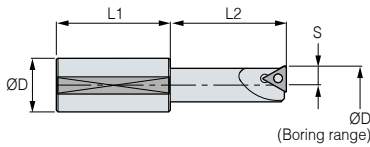

Designation	Boring range(center)		S	øD	L1	L2	Insert	Insert Screw	Wrench
	Min.	Max.							
BB16 - 5(S)	6	20	2.75	16	34	20	WBG0601□□□□	BFTX0203A	TRX06
BB16 - 7(S)	8	22	3.5	16	34	30	TBGT0601□□□□	BFTX0204A	TRX06
BB16 - 9(S)	10	24	4.5	16	34	40	TPGT0802□□□□	BFTX0204A	TRX06
BB16 - 11(S)	12	26	5.5	16	34	45	TPGT1103□□□□	BFTX0307A	TRX10
BB16 - 15(S)	16	30	7.5	16	34	50	TPGT1604□□□□	BFTX0307A	TRX10
BB16 - 19(S)	20	34	9.5	16	60	34	TPGT1604□□□□	BFTX0410A	TRX15

(Unit : mm)

Boring bite : BB type(for KMB)

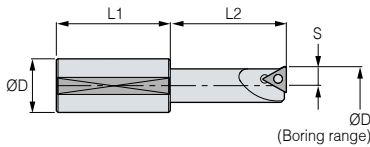

Designation	Boring range(center)				S	øD	L1	L2	Insert	Insert Screw
	Center	Eccentric								
BB18 - 7(S)	8	42	43	91	3.5	18	30	30	TBGT0601□□□□	BFTX0204A
BB18 - 9(S)	10	44	45	93	4.5	18	30	40	TPGT0802□□□□	BFTX0204A
BB18 - 11(S)	12	46	47	95	5.5	18	30	45	TPGT1103□□□□	BFTX0307A
BB18 - 13(S)	14	48	49	97	6.5	18	40	45	TPGT1103□□□□	BFTX0307A
BB18 - 15(S)	16	50	51	99	7.5	18	40	50	TPGT1103□□□□	BFTX0307A
BB18 - 17(S)	18	52	53	101	8.5	18	40	50	TPGT1103□□□□	BFTX0307A

(Unit : mm)

Standard Boring Bite(Insert type)

Maker	Designation	Purpose of use	Boring ø	Insert
SUMITOMO SEI	BBPT (WBPT : Carbide Shank)	for through-hole processing	ø8,10,12,16	TBGT0601□□□□ TPGT0802□□□□, TPGT1103□□□□
	BBPW (WBPW : Carbide Shank)	for Stop and through hole boring	ø5.5,8,10	WBG0601□□□□ WBMT0601□□□□, WBG0802□□□□
	S-SCLCR (C-SCLCR : Carbide Shank)	for Stop and through hole boring	ø8,10,12,16	CCGT0602□□□□, CCMT0602□□□□ CCGT09T3□□□□, CCMT09T3□□□□
	S-STFPR (C-STFPR : Carbide Shank)	for through-hole processing	ø12,16	TPGT1103□□□□
S-STUPR	ø8		TBGT0601□□□□, TPGT0802□□□□	
KORLOY	S-SWUBR (E-SWUBR : Carbide Shank)	for through-hole processing	ø5.5,8,10	WBG0601□□□□, WBG0802□□□□ CCMT0602□□□□, CCGT0602□□□□
	S-SCLCR (C-SCLCR : Carbide Shank)		ø10,12,16	CCMT09T3□□□□, CCGT09T3□□□□
	S-SCLPR (C-SCLPR : Carbide Shank)	for Stop and through hole boring	ø8,10,12,16	CPGT0802□□□□, CPGT0903□□□□

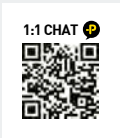

BH

Square boring bite for BSA

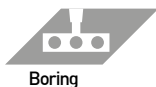

Boring

Fig.1

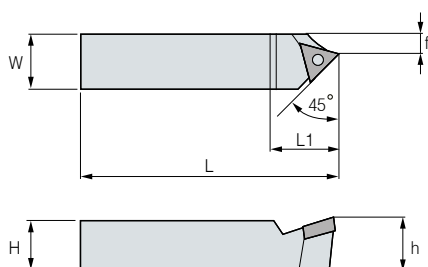
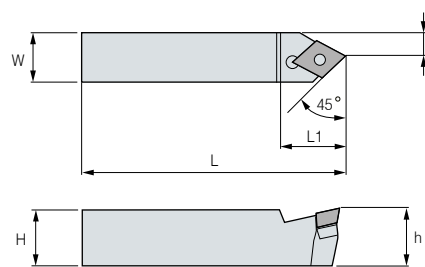

Fig.2



Designation	Fig.	W=H	H	L	L1	f	Usable insert	Insert screw	Insert wrench
BH408	1	8	7.8	40	9	3.2	TPGT0802□□L	BFTX0204A	TRX06
BH410	2	10	9.8	50	10	4.2	CPMT0602□□	BFTX02056N	TRX08
BH413	2	13	12.8	60	14	6.2	CPMT0803□□	BFTX0307N	TRX10
BH416	2	16	15.8	80	18	7.3	CPMT0903□□	BFTX0407A	TRX15
BH419	2	19	18.8	95	22	10.3	CPMH1204□□	BFN0511T	TRX20
BH425	2	25	24.8	125	26	14.2	CPMH1604□□	BFX0611R	LW-3.0

(Unit : mm)

Insert for Square Boring Bite

Maker	Insert	Grade	Workpiece	Cutting
KORLOY	CCGT0602□□-AK	H01	Aluminum	General
	CCGT09T3□□-AK			
	CCGT1204□□-AK			

Maker	Insert	Grade	Workpiece	Cutting
SUMITOMO	TPGT0802□□	Cermet : T1500A	Steel, Cast iron, Stainless Steel	finishing
	CPMT0602□□	Coated : AC6030M	Steel	general
	CPMT0803□□	Coated : AC6030M	Steel	general
	CPMT0903□□	Coated: AC8015P	Steel, Alloy Steel, Cast iron	general
		Coated: AC6030M	Stainless Steel	general
		Cermet : T3000Z	Steel, Cast iron, Stainless Steel	finishing~general
	CPMH1204□□	Coated: AC6030M	Steel, Stainless Steel	general
CPMH1604□□	Coated: AC6030M	Steel, Stainless Steel	general	

Chuck
Arbor/Modular
Boring tool
Angular head
CBN/PCD
TAUMAX
Other



BSA SPARE PART

Boring bar related parts





Main components

SPARE PART	Type	Main components	
	Images	Set screw	
Model No.			
BSA25		BTF0606	
BSA30		BTF0606	
BSA38		BTF0808	
BSA42		BTF0810	
BSA50		BTF1012	
BSA62		BTF1016	
BSA72		BTF1216	
BSA90		BTF1220	

Accessories

• For more information on BH boring bite, see **211p**.

SPARE PART	Type	Accessories	
	Images	Bite	Wrench
Model No.			
BSA25		BH408	LW-3
BSA30		BH408	LW-4
BSA38		BH410	LW-4
BSA42		BH410	LW-5
BSA50		BH413	LW-5
BSA62		BH416	LW-5
BSA72		BH419	LW-5
BSA90		BH419	LW-6

Chuck

Arbor/Modular

Boring tool

Angular head

CBN/PCD

TAUMAX

Other

1:1 CHAT



BT-BKA

FZ Micro boring bar

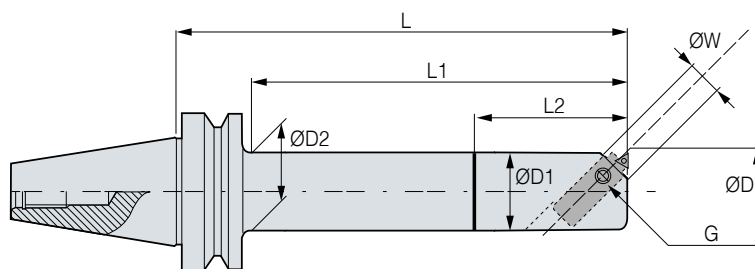

● : Stock

C This product does not support the internal coolant system

※ Red : Main component Blue : For separate purchase

※ The boring unit is an item for separate purchase.

※ For more information on the boring range and insert used, see the FZ unit table.

• For more information on the FZ unit, see **216p**.

• For more information on the related parts, see **217p**.

	Designation	Stock	FZ unit	Stock	L	L1	L2	ØD1	ØD2	W	G	Kg	Package weight(Kg)	
BT30	BT30-BKA28-150	●	FZ10-□□-3(S)	●	150	123	-	25	-	10	M6	0.9	1	
	BT30-BKA36-150	●	FZ12-□□-3(S)	●	150	125	-	32	-	12	M8	1.2	1.3	
	BT30-BKA45-150	●	FZ16-□□-3(S)	●	150	128	-	40	-	16	M10	1.6	1.7	
BT40	BT40-BKA23-150	●	FZ8-□□-3(S)	●	150	95	40	20	22	8	M6	1.6	1.9	
	BT40-BKA23-225		FZ8-□□-3(S)	●	225	95	40	20	22	8	M6	2.8	3.1	
	BT40-BKA28-165	●	FZ10-□□-3(S)	●	165	122	50	25	26	10	M6	1.5	1.7	
	BT40-BKA28-225	●	FZ10-□□-3(S)	●	225	125	50	25	26	10	M6	2.6	2.9	
	BT40-BKA36-165	●	FZ12-□□-3(S)	●	165	133	60	32	35	12	M8	1.9	2.1	
	BT40-BKA36-225	●	FZ12-□□-3(S)	●	225	193	60	32	35	12	M8	2.8	3.1	
	BT40-BKA45-165	●	FZ16-□□-3(S)	●	165	133	70	40	44	16	M10	2.3	2.6	
	BT40-BKA45-225	●	FZ16-□□-3(S)	●	225	208	70	40	44	16	M10	3	3.2	
	BT40-BKA56-165	●	FZ20-□□-3(S)	●	165	-	70	50	54	20	M12	3	3.2	
	BT40-BKA56-240	●	FZ20-□□-3(S)	●	240	-	70	50	54	20	M12	4.2	4.5	
	BT40-BKA72-165	●	FZ25-□□-3(S)	●	165	-	-	63	-	25	M16	4	4.2	
	BT40-BKA72-240	●	FZ25-□□-3(S)	●	240	-	-	63	-	25	M16	5.7	5.9	
	BT40-BKA90-165	●	FZ32-□□-3(S)	●	165	-	100	80	-	32	M20	4.9	5.2	
	BT40-BKA90-240		FZ32-□□-3(S)	●	240	-	100	80	-	32	M20	6.8	7	

(Unit : mm)



BT-BKA

FZ Micro boring bar

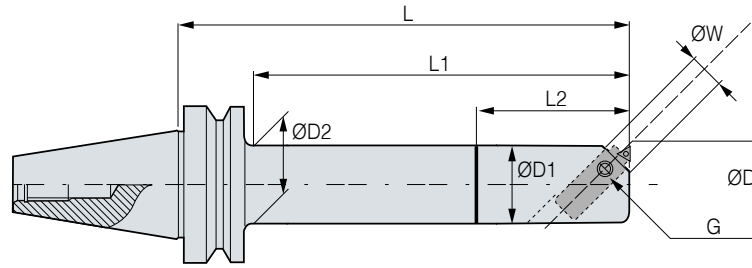

● : Stock

C This product does not support the internal coolant system

※ Red : Main component Blue : For separate purchase

※ The boring unit is an item for separate purchase.

※ For more information on the boring range and insert used, see the FZ unit table.

• For more information on the FZ unit, see **216p**.

• For more information on the related parts, see **217p**.

	Designation	Stock	FZ unit	Stock	L	L1	L2	ØD1	ØD2	W	G	Kg	Package weight(Kg)
BT50	BT50-BKA23-150		FZ8-□□-3(S)	●	150	95	40	20	22	8	M6	4.2	4.6
	BT50-BKA23-225		FZ8-□□-3(S)	●	225	95	40	20	22	8	M6	5.3	5.7
	BT50-BKA28-165	●	FZ10-□□-3(S)	●	165	122	50	25	26	10	M6	4.1	4.5
	BT50-BKA28-225	●	FZ10-□□-3(S)	●	225	122	50	25	26	10	M6	5.1	5.5
	BT50-BKA36-165	●	FZ12-□□-3(S)	●	165	122	60	32	35	12	M8	4.4	4.8
	BT50-BKA36-225	●	FZ12-□□-3(S)	●	225	182	60	32	35	12	M8	4.9	5.3
	BT50-BKA45-165	●	FZ16-□□-3(S)	●	165	122	70	40	44	16	M10	4.8	5.2
	BT50-BKA45-225	●	FZ16-□□-3(S)	●	225	182	70	40	44	16	M10	5.5	5.9
	BT50-BKA56-165	●	FZ20-□□-3(S)	●	165	122	70	50	54	20	M12	5.5	5.9
	BT50-BKA56-240	●	FZ20-□□-3(S)	●	240	197	70	50	54	20	M12	6.7	7.1
	BT50-BKA72-165	●	FZ25-□□-3(S)	●	165	122	80	63	68	25	M16	6.5	6.9
	BT50-BKA72-240	●	FZ25-□□-3(S)	●	240	197	80	63	68	25	M16	8.5	8.9
	BT50-BKA90-165	●	FZ32-□□-3(S)	●	165	122	90	80	-	32	M20	7.9	8.3
	BT50-BKA90-240	●	FZ32-□□-3(S)	●	240	197	-	80	-	32	M20	10.9	11.3
	BT50-BKA110-270	●	FZ32-□□-3(S)	●	270	-	-	100	-	32	M20	14.8	15.2

(Unit : mm)

Chuck

Arbor/Modular

Boring tool

Angular head

CBN/PCD

TAUMAX

Other



FZ UNIT

FZ Unit Inclined mounting type

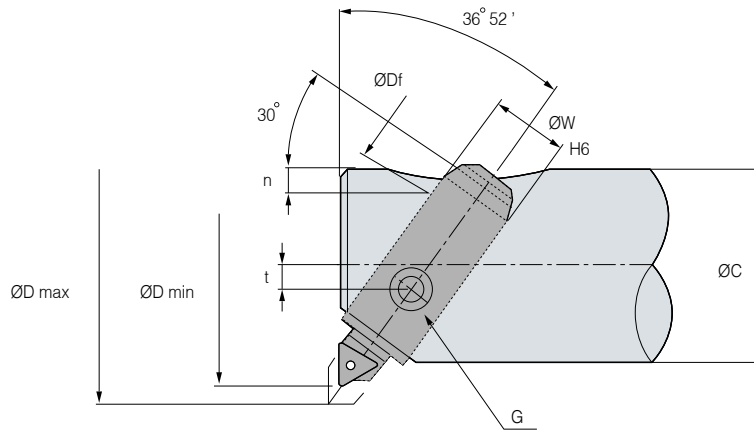
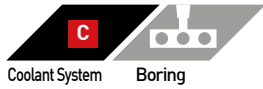

C This product does not support the internal coolant system

※ In case of one gradation adjustment, $\varnothing 0.02\text{mm}$

• For more information on the insert, see **217p**

• For more information on the related parts, see **217p**

	Designation	ØD		Insert holder (ISO)	Insert (ISO)	ØC	n	ØDf	t	G	W	Kg	Package weight(Kg)
		MIN	MAX										
FZ8	FZ8-23-3(P10,K10)	23	29(32)	8Z3 [Braze tip]	-	20	3	8	1.5	M6	8	0.04	0.04
	FZ8-26-3(P10,K10)	26	32(34)	8Z3 [Braze tip]	-	20	3	8	1.5	M6	8	0.04	0.04
FZ10	FZ10-28-3(S)	28	34(38)	U10Z3S	TBGT0601□□L	25	3.5	8	2	M6	10	0.1	0.1
	FZ10-32-3(S)	32	38(44)	U10Z3S	TBGT0601□□L	25	3.5	8	2	M6	10	0.1	0.1
FZ12	FZ12-36-3(S)	36	44(48)	U12Z3S	TBGT0601□□L	32	4	10	2.5	M8	12	0.1	0.1
	FZ12-40-3(S)	40	48(55)	U12Z3S	TBGT0601□□L	32	4	10	2.5	M8	12	0.1	0.1
FZ16	FZ16-45-3(S)	45	54(60)	U16Z3S	TPGT0802□□L	40	6.5	12	3	M10	16	0.1	0.0
	FZ16-50-3(S)	50	59(68)	U16Z3S	TPGT0802□□L	40	6.5	12	3	M10	16	0.1	0.1
FZ20	FZ20-56-3(S)	56	68(78)	U20Z3S	TPGT0802□□L	50	7	16	5	M12	20	0.2	0.2
	FZ20-64-3(S)	64	76(90)	U20Z3S	TPGT0802□□L	50	7	16	5	M12	20	0.2	0.2
FZ25	FZ25-72-3(S)	72	88(100)	U25Z3S	TPGT1103□□L	63	8	20	4	M16	25	0.3	0.3
	FZ25-80-3(S)	80	96(114)	U25Z3S	TPGT1103□□L	63	8	20	4	M16	25	0.3	0.3
FZ32	FZ32-90-3(S)	90	114(126)	U32Z3S	TPGT1103□□L	80	10	25	6	M20	32	0.6	0.6
	FZ32-100-3(S)	100	124(140)	U32Z3S	TPGT1103□□L	80	10	25	6	M20	32	0.6	0.6
	FZ32-110-3(S)	110	134(150)	U32Z3S	TPGT1103□□L	100	10	25	12	M20	32	0.7	0.7
	FZ32-125-3(S)	125	149(175)	U32Z3S	TPGT1103□□L	100	10	25	12	M20	32	0.8	0.8

(Unit : mm)



FZ UNIT SPARE PART

FZ unit related parts



SPARE PART

Type	Main components					Accessories
	Housing	Spindle	Insert screw	Torx Wrench	L-Wrench	Torx Wrench
Images						
Model No.						
FZ8-23, 26-3, P10	8-23, 26-3	8Z3(P10)	-	-	LW-1.5	R0/N0
FZ8-23, 26-3, K10	8-23, 26-3	8Z3(P10)	-	-	LW-1.5	R0/N0
FZ10-28, 32-3(S)	10-28, 32-3	U10Z3-TB06	BFTX0204A	TRX6	LW-2.0	R2/N1
FZ12-36, 40-3(S)	12-36, 40-3	U12Z3-TB06	BFTX0204A	TRX6	LW-2.5	R2A/N2
FZ16-45, 50-3(S)	16-45, 50-3	U16Z3-TP08	BFTX0204A	TRX6	LW-3.0	N3
FZ20-56, 64-3(S)	20-56, 64-3	U20Z3-TP08	BFTX0204A	TRX6	LW-4.0	R4/N4
FZ25-72, 80-3(S)	25-72, 80-3	U25Z3-TP11	BFTX0307A	TRX10	LW-4.0	ZV25
FZ32-90, 100, 110, 125-3(S)	32-90, 100-3	U32Z3-TP11	BFTX0307A	TRX10	LW-5.0	R5/N5



INSERT

FZ UNIT, FF UNIT



Fig.1
(With Chip Breaker)

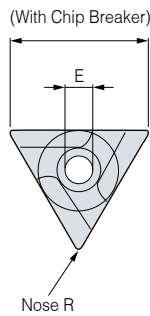

Fig.2
(Without Chip Breaker)

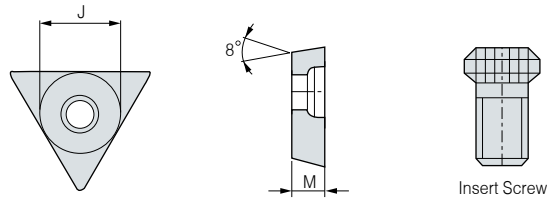

Fig.	Grade of Insert	Workpiece
1	K10(W.C)	Cast Iron, Aluminum
1	P10(W.C)	Steel, Stainless Steel
1	CN1000 or CN2000(Cermet)	Steel
2	K10(W.C)	Exclusive for Cast Iron

INSERT	Fig.	J	R	M	E	Insert screw	Wrench
TBGT0601□□L	1	3.97	0.2	1.59	2.2	BFTX0204A	TRX6
TPGT0802□□L	1	4.76	0.2	2.38	2.4	BFTX0204A	TRX6
TPGT1103□□L	1	6.35	0.4	3.18	2.8	BFTX0307A	TRX10

(Unit : mm)

Chuck

Arbor/Modular

Boring tool

Angular head

CBN/PCD

TAUMAX

Other



BT-BCF

Micro boring bar



MAS
403-BT
C
29.5
141

Shank Coolant System MIN Range MAX Range Boring

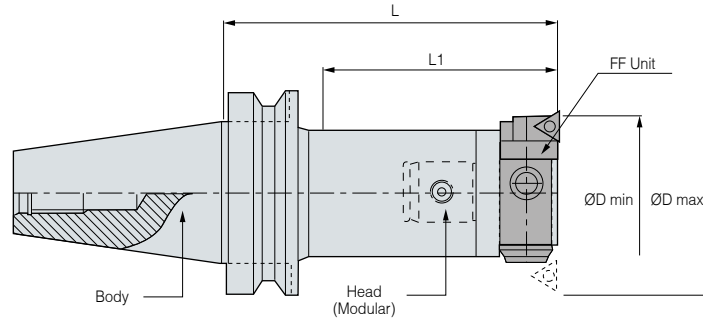

● : Stock

C This product does not support the internal coolant system

※ Red : Main component Blue : For separate purchase

※ The bodies, boring units, and head sets are sold individually

※ Right-angled type micro boring bar

• For more information on FF boring unit, see **220p**.

• For more information on the related parts, see **220p**.

• For more information on the applicable insert, see **221p**.

	Designation				ØD		L	L1	Head weight(Kg)	Body weight(Kg)	
	Body model no.	Head model no.	Stock	Boring Unit	Stock	Min.					Max.
BT30	BT30-MD25F-90	BCF2530	●	FF10-30[S]	●	29.5	42	140	113	0.3	0.6
	BT30-MD32F-80	BCF3239	●	FF12-39[S]	●	39	50	140	115	0.4	0.7
	BT30-MD40F-80	BCF4047	●	FF16-47[S]	●	47	66	140	116	0.6	0.9
	BT30-MD50F-70	BCF5058	●	FF20-58[S]	●	58	83	140	117	1	0.9
BT40	BT40-MD25F-95	BCF2530	●	FF10-30[S]	●	29.5	42	145	113	0.3	1.1
	BT40-MD32F-100	BCF3239	●	FF12-39[S]	●	39	50	160	130	0.4	1.1
	BT40-MD40F-115	BCF4047	●	FF16-47[S]	●	47	66	175	143	0.6	1.6
	BT40-MD50F-105	BCF5058	●	FF20-58[S]	●	58	83	175	143	1	1.8
	BT40-MD63F-110	BCF6379	●	FF25-79[S]	●	79	108	180	152	1.7	2.4
	BT40-MD80F-100	BCF100	●	FF32-100[S]	●	100	141	200	172	3.8	2.9
BT50	BT50-MD25F-105	BCF2530	●	FF10-30[S]	●	29.5	42	155	112	0.3	4.1
	BT50-MD32F-110	BCF3239	●	FF12-39[S]	●	39	50	170	127	0.4	4.3
	BT50-MD40F-195	BCF4047	●	FF16-47[S]	●	47	66	255	212	0.6	5.2
	BT50-MD50F-225	BCF5058	●	FF20-58[S]	●	58	83	295	252	1	6.4
	BT50-MD63F-195	BCF6379	●	FF25-79[S]	●	79	108	265	222	1.6	7.2
	BT50-MD80F-175	BCF100	●	FF32-100[S]	●	100	141	275	234	3.8	8.4

※ Boring unit (Insert)

- FF10-30(S) / FF12-39(S) (TBGT0601□□L)
- FF16-47(S) / FF20-58(S) (TPGT0802□□L)
- FF25-79(S) / FF32-100(S) (TPGT1103□□L)

(Unit : mm)



BT-BCF

Micro boring bar



Fig.1

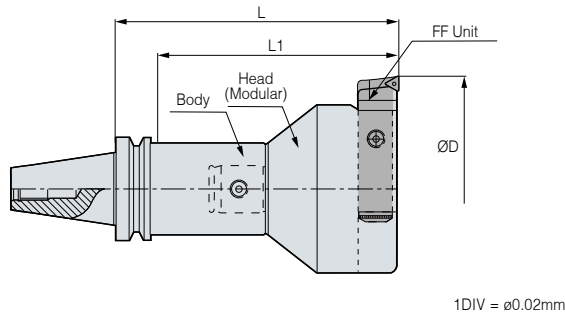
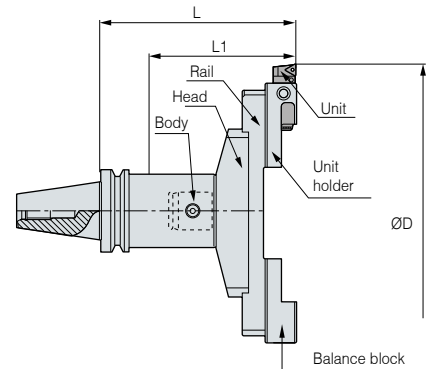

Fig.2



1DIV = ø0.02mm

- : Will be discontinued
- : Stock

C This product does not support the internal coolant system

※ Red : Main component Blue : For separate purchase

※ The bodies, boring units, and head sets are sold individually

※ Modular type micro boring bar

• For more information on FF boring unit, see **220p**.

• For more information on the related parts, see **220p**.

• For more information on the applicable insert, see **221p**.

	Designation				ØD		L	L1	Fig.	Package weight(Kg)	
	Body model no.	Head model no.	Stock	Boring Unit	Stock	Min.					Max.
BT50	BT50-MD90F-75	BCF138	●	FF32-138(S)	●	138	159	175	136.5	1	8
	BT50-MD90F-145	BCF138	●	FF32-138(S)	●	138	159	245	204	1	9
	BT50-MD90F-75	BCF150	●	FF32-138(S)	●	150	171	175	136.5	1	9.6
	BT50-MD90F-145	BCF150	●	FF32-138(S)	●	150	171	245	204	1	12.4
	BT50-MD90F-195	BCF150	●	FF32-138(S)	●	150	171	295	254	1	15.4
	BT50-MD90F-75	BCF170	●	FF32-138(S)	●	170	191	175	136.5	1	9.8
	BT50-MD90F-145	BCF170	●	FF32-138(S)	●	170	191	245	204	1	12.6
	BT50-MD90F-195	BCF170	●	FF32-138(S)	●	170	191	295	254	1	15.8
	BT50-MD90F-75	BCF190	●	FF32-138(S)	●	190	211	175	136.5	1	10.2
	BT50-MD90F-145	BCF190	●	FF32-138(S)	●	190	211	245	204	1	13
	BT50-MD90F-195	BCF190	●	FF32-138(S)	●	190	211	295	254	1	16.1
	BT50-MD90F-75	BCF210	●	FF32-138(S)	●	210	231	175	136.5	1	10.5
	BT50-MD90F-145	BCF210	●	FF32-138(S)	●	210	231	245	204	1	13.4
	BT50-MD90F-195	BCF210	●	FF32-138(S)	●	210	231	295	254	1	16.5
	BT50-MD90F-75	BCF230	●	FF32-138(S)	●	230	251	175	136.5	1	13.1
	BT50-MD90F-145	BCF230	●	FF32-138(S)	●	230	251	245	204	1	15.6
	BT50-MD90F-195	BCF230	●	FF32-138(S)	●	230	251	295	254	1	18.2
	BT50-MD90F-75	BCF250FS	○	FF25-79(S)	●	250	355	182	143.5	2	14.3
	BT50-MD90F-145	BCF250FS	○	FF25-79(S)	●	250	355	252	211	2	17.2
	BT50-MD90F-195	BCF250FS	○	FF25-79(S)	●	250	355	302	261	2	21.2
BT50-MD90F-75	BCF350FS	○	FF25-79(S)	●	350	450	182	143.5	2	16.4	
BT50-MD90F-145	BCF350FS	○	FF25-79(S)	●	350	450	252	211	2	19	
BT50-MD90F-195	BCF350FS	○	FF25-79(S)	●	350	450	302	261	2	20.8	

※ Boring unit (Insert)

- FF25-79(S) / FF32-138(S) (TPGT1103□□L)

(Unit : mm)

Chuck

Arbor/Modular

Boring tool

Angular head

CBN/PCD

TAUMAX

Other



FF

FF Unit

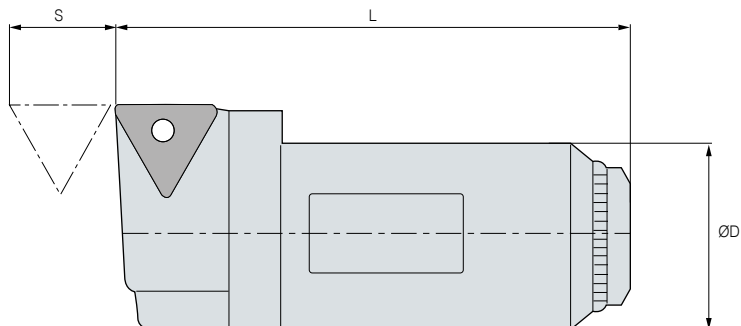

C This product does not support the internal coolant system

Designation	ØD	L	S	Usable insert
FF10-30(S)	10	28.5	3.5	TBGT0601□□L
FF12-39(S)	12	37.5	3.5	TBGT0601□□L
FF16-47(S)	16	45	5	TPGT0802□□L
FF20-58(S)	20	56	7	TPGT0802□□L
FF25-79(S)	25	77.5	8	TPGT1103□□L
FF32-100(S)	32	97	11	TPGT1103□□L
FF32-138(S)	32	131	11	TPGT1103□□L



FF UNIT SPARE PART

FF Unit related parts



Type	Main components		
	Clamp screw	Torx Wrench	Wrench
Images			
Head Set			
FF10-30(S)	BFTX0204A	TRX06	LW-2
FF12-39(S)	BFTX0204A	TRX06	LW-2.5
FF16-47(S)	BFTX0204A	TRX06	LW-3
FF20-58(S)	BFTX0204A	TRX06	LW-4
FF25-79(S)	BFTX0307A	TRX10	LW-4
FF32-100(S)	BFTX0307A	TRX10	LW-5



INSERT

Boring Insert

Insert	Applicable products (Boring head)
CCET0301□□L	FBB15C(FBH15,FBH18)
CCET0401□□L	FBB20N-C, FBB20N-1-C(FBH1920B) FBB26N-C, FBB26N-1-C(FBH2526B)
CCMT0602□□L	BCC28(DBC2528S),BCC35(DBC3235S), FBB33N-C, FBB33N-1-C(FBH3233B), FBH42N-C, FBH42N-1-C(FBH4042B), FBH53N-1-C(FBH5053B)
CCGT0602□□L	
CPMT0602□□L	BH410(BSA38,BSA42)
CPMT0803□□L	BH413(BSA50)
CCMT09T3□□L	BCC46(DBC4046S),BCC58(DBC5058S), FBB53N-C, FBH53N-1-C09(FBH5053B), FBB68N-C, FBB68N-C09, FBB68N-1-C09(FBH6368B, FBH6398B, FBH8098B), FBB130-C09(FBC130,FBC175,FBC220,FBC265,FBC310,FBC385,FBC460)
CCGT09T3□□L	
CPMT0909□□L	BH416(BSA62)
CCMT1204□□L	BCC74(DBC6374S),BCC94(DBC8094),BCC120(DBC120S), BCC1348(TBC130,TBC175,TBC220,TBC265), BCC1354(TBC310,TBC385,TBC460)
CCGT1204□□L	FBB130-C12(FBC130,FBC175,FBC220,FBC265,FBC310,FBC385,FBC460)
CPMH1204□□L	BH419(BSA72,BSA90)
WBG0601□□L	BB16-5(S)(SMH4022)
TBGT0601□□L	BB16-7(S), BB18-7(S)(KMB6336,SMB4022) FZ10-28-3(S),FZ10-32-3(S)(BSA30) FZ12-36-3(S),FZ12-40-3(S)(BSA38) FF10-30(S)(BCF2530),FF12-39(S)(BCF3239)
TPGT0802□□L	BB16-9(S)(SMH4022),BB18-9(S)(KMB6336,SMB4022) BH408(BSA25, BSA28), FBB20N,FBB20N-1(FBH1920B), FBB26N,FBB26N-1(FBH2526B), FBB33N,FBB33N-1(FBH3233B), FBB42N, FBB42N-1(FBH4042B)
TPGW0802□□	FZ16-45-3(S),FZ16-50-3(S)(BSA42) FZ20-56-3(S),FZ20-64-3(S)(BSA50) FF16-47(S)(BCF4047), FF20-58(S)(BCF5058)
TPGT1103□□L	FBB42N-T11,FBB42N-1-T11(FBH4042B), FBB53N-11, FBB53N-1-T11(FBH5053B) FBB68N-11,FBB68N-1-T11(FBH6368B, FBH6398B, FBH8098B) FBB130-T11(FBC130,FBC175,FBC220,FBC265, FBC310,FBC385,FBC460) BB16-11(S),15(S),19(S)(SMH4022) BB18-11(S),13(S),15(S),17(S)(KMB6336,SMB4022) FZ25-72-3(S),FZ25-80-3(S)(BSA62) FZ32-90-3(S), FZ32-100-3(S)(BSA72) FZ32-110-3(S),FZ32-125-3(S)(BSA90)FF25-79(S)(BCF6379,BCF250FS,BCF350FS), FF32-100(S)(BCF100), FF32-138(S)(BCF138,BCF170,BCF190,BCF210,BCF230)
TPGT1604□□L	BB16-19(S)(SMH4022)
CPMH1604□□L	BH425(BSA105)

Chuck

Arbor/Modular

Boring tool

Angular head

CBN/PCD

TAUMAX

Other



Angular Head

DINOX NC TOTAL TOOLING SYSTEM

ANGULAR HEAD	224
SAH	227
KHU	228
MAH	230
KAG	232
HRAG	234
KAH	236
KAC	238
POSITIONING BLOCK	240
ATM	242



ANGULAR HEAD

Angular head

KHU

Angle adjustment type angular head



Wide machining angle range from 0° to 90°

- HSK and SK types are customizable

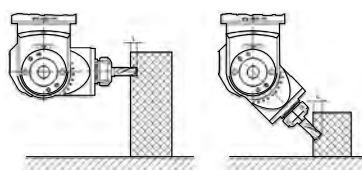

BT50-KHU20-195



MAH

Rigidity-reinforced side lock type MAH (Reinforced series) / Angle adjustment type angular head



MAH that supports mold machining by improving the performance of the current universal-type product

- Stable machining of large-sized mold
- Supports ball endmill 32mm in diameter (D)
- Improves the rigidity of the KHU type



KAH

Modular type KAH (90° type) / Fixed angle-type angular head



Availability in adjusting horizontal machining angle up to 360°

- To use Tap-exclusive collet, please contact us in advance
- HSK and SK types are customizable

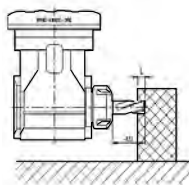

BT50-KAH20-200





ANGULAR HEAD

Angular head

KAG

Attachment type KAG / Attachment-type angular head



Wide horizontal machining angle range from 0° to 360°

- Compatible with various tools for BT40 and BT30
- HSK and SK types are customizable

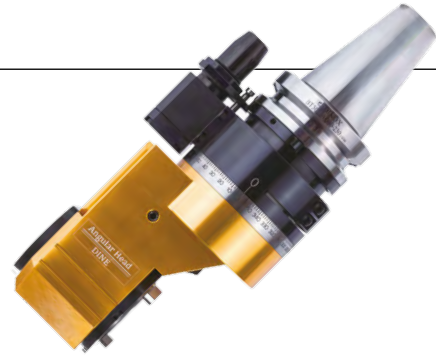
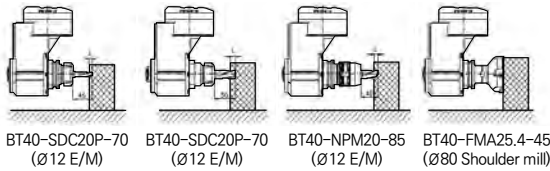

HRAG

Attachment type HRAG (Reinforced type) / Attachment-type angular head



HRAG that improves the rigidity of the attachment-type bracket by 200%

- Provides stable operation of the face mill cutter
- Improves the rigidity of the KAG type



KAC

Modular type KAC (45° type) / Fixed angle-type angular head



Availability in adjusting horizontal machining angle up to 360°

- HSK and SK types are customizable



Chuck

Arbor/Modular

Boring tool

Angular head

CBN/PCD

TAUMAX

Other

1:1 CHAT



ANGULAR HEAD

Angular head

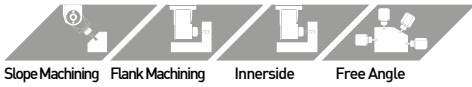

Slope Machining Flank Machining Innerside Free Angle

Features

- Effect of two machines with one
- Various angle machining available
- Light aluminium body

NAMING

BT50	—	KHU	—	10	—	195
Spindle		Angular head		Tool Dia.		Length



Names of each part

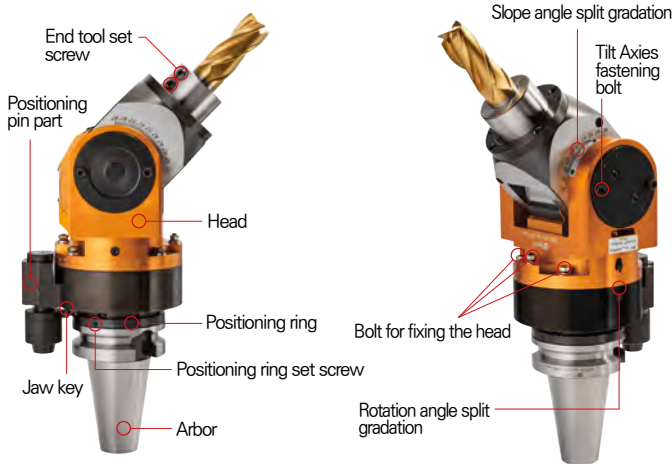

Positioning pin details

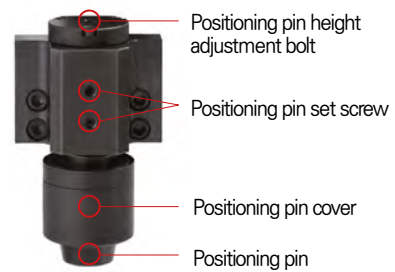

Components





BT-SAHA

Slim Angular head



Features

- Angular head for narrow inside boring (min. inner diameter of workpiece : $\varnothing 40$, min. boring width : 32mm)
- MAX 3,500RPM, Spindle : applied rotation ratio = 1:1.37
- Boring range : $\varnothing 3$, $\varnothing 4$, $\varnothing 6$

NAMING

BT50	—	SAH	—	6	—	277
Spindle		Slim Angular head		Tool Dia.		Length

Details

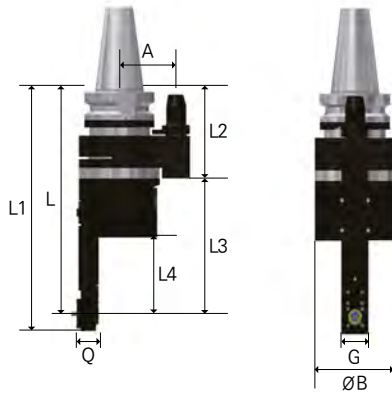

• ● : Stock

	Designation	L	L1	L2	L3	L4	A	Q	G	ØB	Rotation ratio (IN:OUT)	Rotation direction	MAX RPM	Weight (Kg)	Stock
BT50	BT50-SAHA6-277	277	298	183.5	166.5	93.5	80(110)	31.5	40	76	1:1.37	CW: CW	3,500	15.2	●

(Unit : mm)

Clamping Force

※ The moderate clamp torque of collet is 3.5N-m

	Measurement	Measured value (N-m)			
Clamp torque	2	2.5	3	3.5	4
Clamping Force	Not measurable	5.5	6.5	7	7

Collet

• ● : Stock

	Designation	Clamping Range	Stock
	SAH6-C3	3	●
	SAH6-C4	4	●
	SAH6-C6	6	●

Machining Features

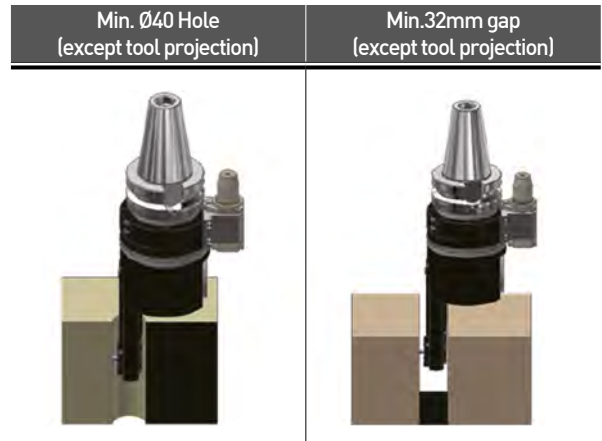

How to clamp

1. Insert the tool with SAH collet
2. Insert the coupled collet into SAH and fix it with a clamping jig
3. Clamping nut using a wrench

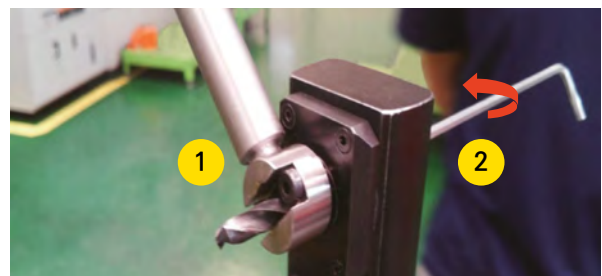

Chuck

Arbor/Modular

Boring tool

Angular head

CBN/PCD

TAUMAX

Other



BT-KHU

KHU_Collet type angular head (0°-90°)



KHU Features

Adjustable angle-type angular head that enables flexible machining

- Wide vertical (0°~90°) and horizontal (0°~360°) machining angle range
- To use Tap-exclusive collet, please contact us in advance
- HSK and SK types are customizable

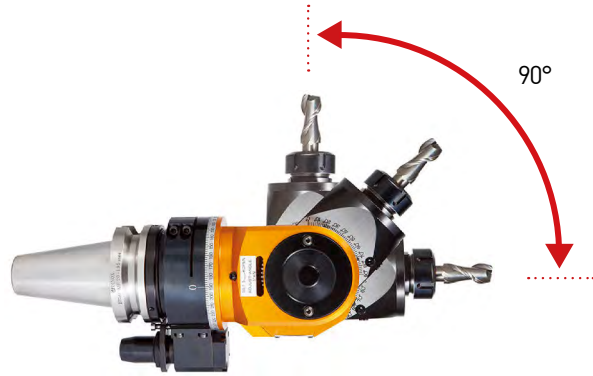

Precautions

Do not inject cutting oil direct to the angular head body.



Wear of the ball endmill blade and defective surface roughness of the workpiece can occur, so please slope the edge of the ball endmill when machining

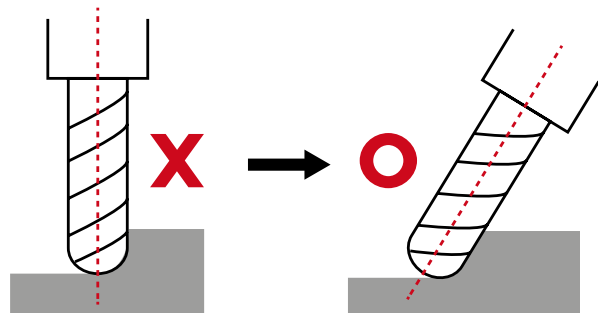

Machining Example

Model : BT50-KHU20-195

Cutting tool	Workpiece	Cutting depth	RPM	Feed (mm/min)	Feed (mm/rev)	Cutting angle
Ø16-2 Flute Endmill(HSS), Over length-40mm	S45C	2	600	48	0.04	90°
	AL	3	1200	168	0.07	90°
	S45C	3	600	48	0.04	45°
	AL	5	1200	144	0.06	45°

SPARE PART	Angular head	Main components		For separate purchase
		Nut	Spanner	GERC Collet
	KHU10	R16-AH	S-25	GERC16-ØD
	KHU20	RU32-AH	48-52	GERC32-ØD



BT-KHU

KHU_Collet type angular head (0°-90°)

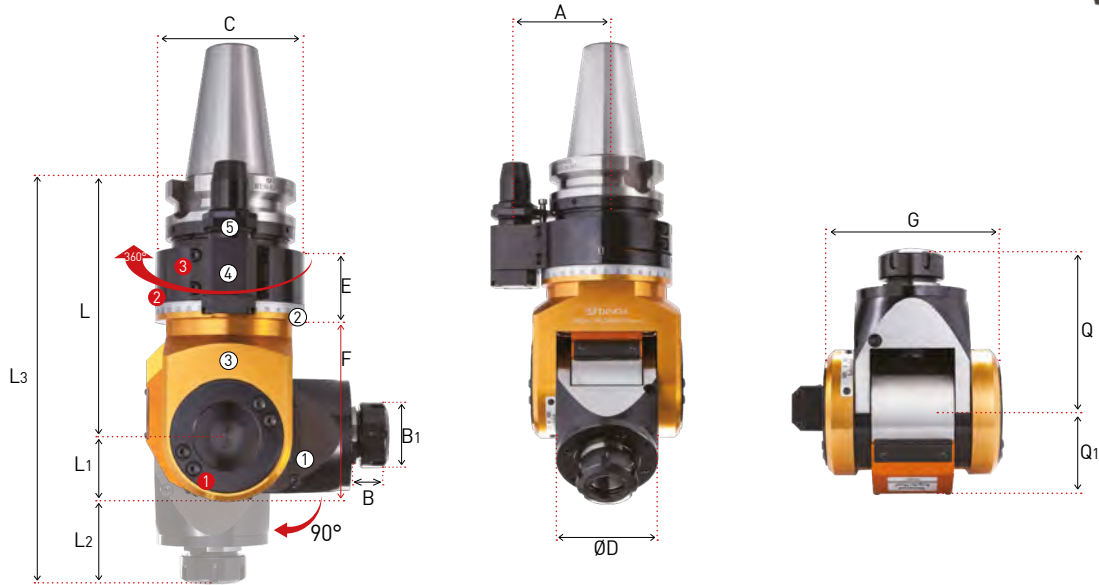

Positioning pin

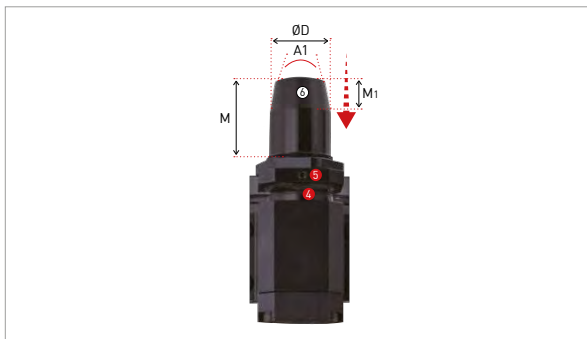

Taper No.	M	M1	A1	ØD
BT40	Max : 32 / Min : 26	10	20°	Ø19.6
BT50	Max : 35 / Min : 29	15	20°	Ø28

NO	Name
①	Slope angle split gradation (0 - 90°)
②	Rotation angle split-gradation (360°)
③	Head
④	Position fix pin block
⑤	Jaw key
⑥	Height adjusting wrench hole

NO	Parts name	Model No.
①	Tilt Axes fixing bolt	BH0630
②	Bracket angle fixing bolt	BX0630
③	Position block fixing bolt	BX0512
④	Set screw	BT0404
⑤	Fixing bolt	BX05630

● : Stock

C This product does not support the internal coolant system

• For more information on the applicable collet, see **96p**

• For more information on positioning block, see **240p**

	Designation	ØD(Clamping Range)	B	C	E	F	C2	L1	L2	L3	L	ØD	A	G	Q	Q1	Gear ratio	Rotation direction versus spindle	MAX RPM	Applicable collet	Kg	Package weight (Kg)	Stock	
BT40	BT40-KHU10-160	1.0~10.0	22	28	96	51	98	96	160	33	54	247	84	65	90	87	40	1:2	Normal rotation	6,000	GERC16	8.3	15.2	●
BT50	BT50-KHU10-180	1.0~10.0	22	28	114	53	103	114	180	33	54	267	84	80	90	87	40	1:2	Normal rotation	6,000	GERC16	11.5	23.9	●
	BT50-KHU20-195	1.0~20.0	29	50	114	53	132	114	195	41	73	315	84	80	124	120	63	1:1	Normal rotation	3,000	GERC32	17.9	30.3	●

(Unit : mm)

1:1 CHAT



BT-MAH

Rigidity-reinforced side lock type MAH (Reinforced series) / Angle adjustment



Features of rigidity reinforced type

MAH for mold machining

MAH ideal for mold machining by improving the performance of conventional universal type products

- Stability on large mold machining
- Tool diameter (D) 32mm ball end mill usable

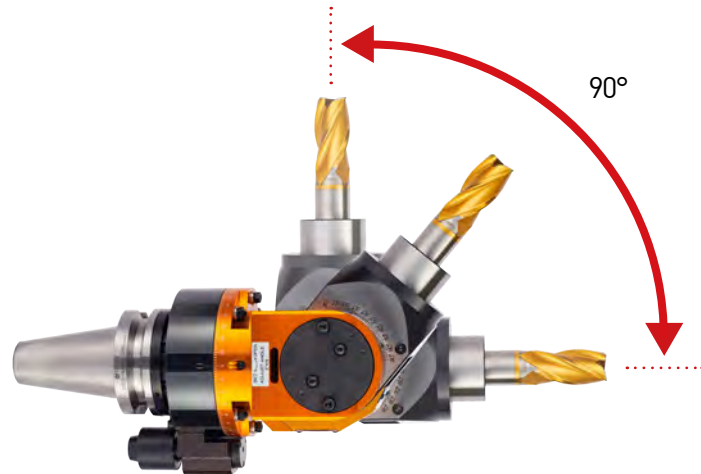

Features of MAH (For mold machining) and its comparison with KHU

MAH

KHU

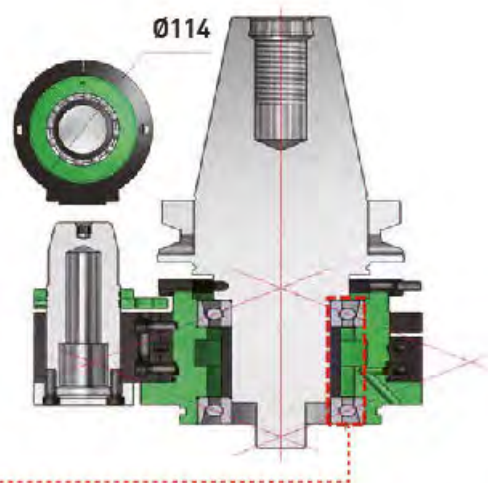
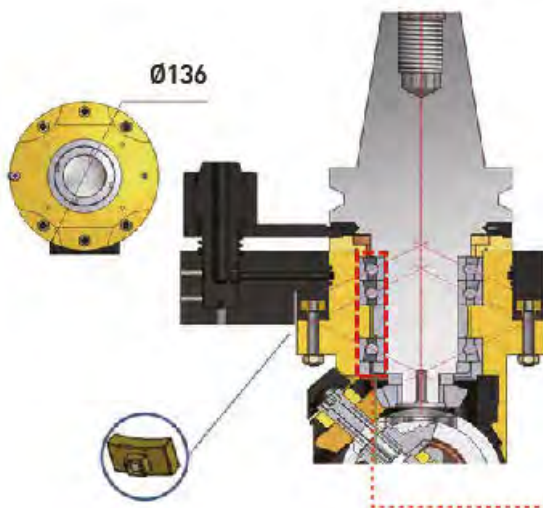

Type	KHU	MAH	MAH Advantages
Joint Type	Bolt	T-nut	Torsional strain improvement
Bearing	2pcs	3pcs	



BT-MAH

Rigidity-reinforced side lock type MAH (Reinforced series) / Angle adjustment

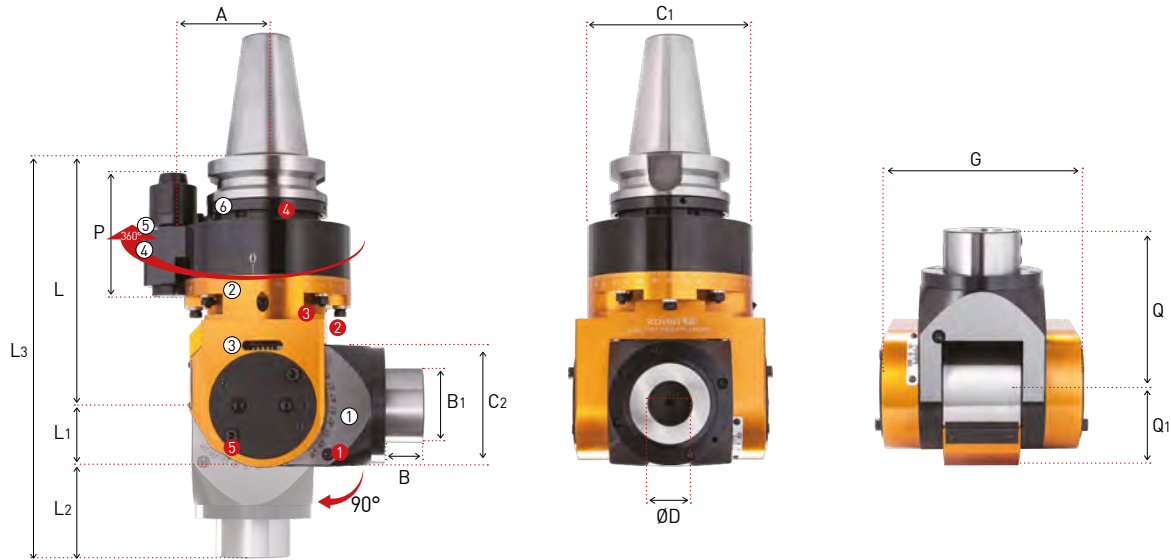

Positioning pin

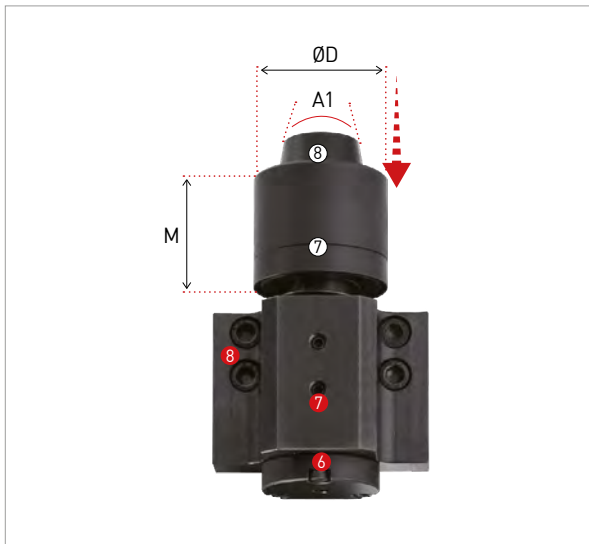

Shank size	M	A1	ØD
BT50	56.5	20°	Ø40

NO	Name
①	Slope angle split gradation (Angles vertically splittable between 0 and 90°)
②	Rotation angle split-gradation (360° freely selectable)
③	Head
④	Positioning pin parts
⑤	Jaw key
⑥	Positioning ring
⑦	Positioning cover
⑧	Positioning pin

NO	Name	Model No.
①	Slope angle split gradation screw	BT1216
②	Head fixing bolt	BT0645
③	Rotation angle split gradation screw	BT0640
④	Positioning ring set screw	MSST5-12
⑤	Tilt Axes fixing bolt	BH0616
⑥	Positioning pin height adjustment screw	BT0516
⑦	Positioning pin set screw	BT0512
⑧	Body position block set block	BX0516

● : Stock

C This product does not support the internal coolant system

• For more information on positioning block, see **241p**

Model No.	ØD	L	L1	L2	L3	C	C1	G	C2	Q	Q1	B	B1	P	A	MAX RPM	Tool mounting	Kg	Package weight (Kg)	Stock
BT50 BT50-MAH32-200	32	200	47	78	325	136	95	54	95	125	63	31	60	95	80	3,000	SIDE LOCK	19.6	32.0	●

(Unit : mm)



BT-KAG

Attachment type KAG / Attachment-type angular head



Features of KAG

- Horizontal machining angle range from 0° to 360°
- Compatible with various tools such as BT40 and BT30
- HSK and SK types are customizable
- Coolant types are to be ordered separately



How to tighten the tool

1. Insert the tool ① into the angular head spindle.
2. Tightly secure the tool ① using the fixing bolt ②. (BT type)
3. Tighten the tool ① by putting the ring on the bolt. (NT type)

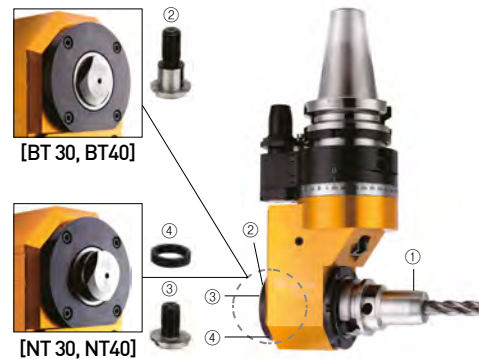

Machining Example

Model : BT50-KAG40-230

Cutting Tool	Workpiece	Cutting depth	RPM	Feed (mm/min)	Feed (mm/rev)
BT40-SDC20-60 Ø12-2 Flute Endmill (HSS)	S45C	3	400	72	0.09
	S45C	3	200	36	0.09
NT40-SDC20-60 Ø20-2 Flute Endmill (HSS)	S45C	4	500	50	0.05
	AL	10	1,000	100	0.05
BT40-NPM20-85 Ø20-2 Flute Endmill (HSS) over hang 40mm	S45C	3	400	72	0.09
	S45C	3	400	36	0.09
	AL	5	400	72	0.09
	AL	5	480	86	0.09
	AL	10	400	72	0.09
	AL	10	320	58	0.09
BT40-FMA25.4-45 Ø80 Shoulder mill (5 Flute-50L)	S45C	2	400	120	
	S45C	1	200	60	
	AL	2	600	150	
	AL	1	600	150	

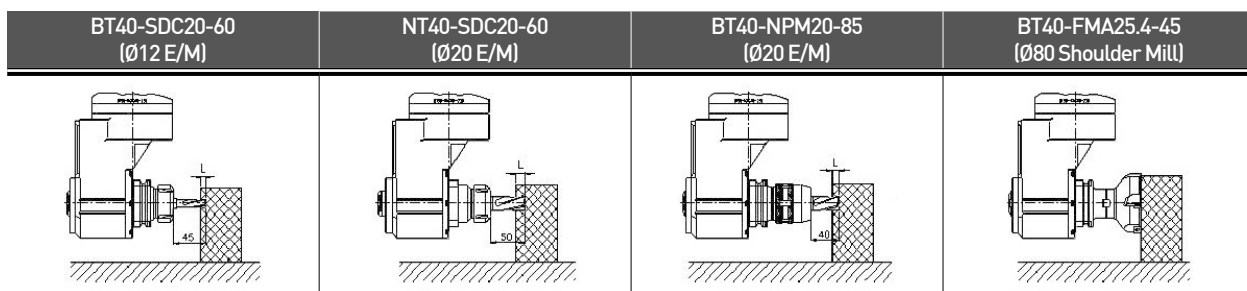



BT-KAG

Attachment type KAG / Attachment-type angular head

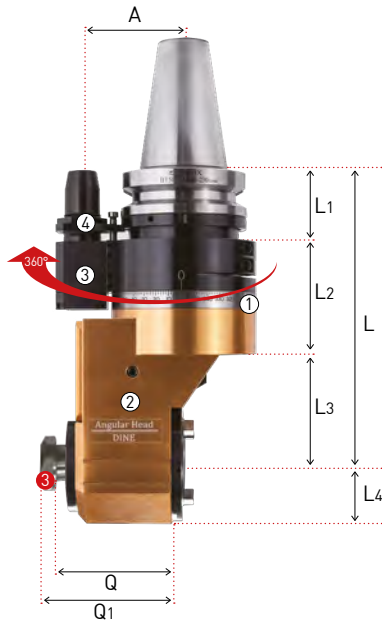

Position pin

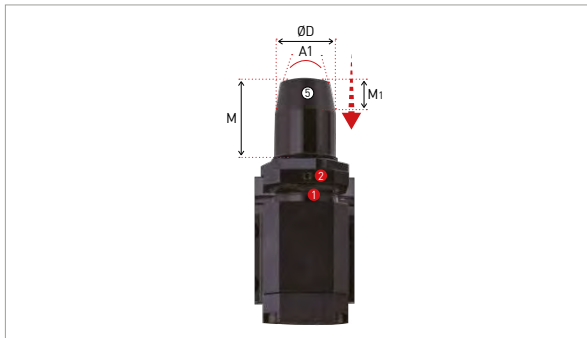

Taper No.	M	M1	A1	ØD
BT40	Max : 32 / Min : 26	10	20°	Ø19.6
BT50	Max : 35 / Min : 29	15	20°	Ø28

NO	Name
①	Rotation angle split-gradation (360°)
②	Head
③	Position fix pin block
④	Jaw key
⑤	Height adjusting wrench hole

NO	Name	Model No.
①	Set screw	BT0404
②	Position pin height fix bolt	BX50630
③	BT / NT bolt	

● : Stock

C This product does not support the internal coolant system

• For more information on positioning block, see **241p**

	Designation	L	L1	L2	L3	L4	Q	Q1	A	C	G	Gear ratio	Rotation direction versus spindle	MAX RPM	Holder shank mounted	Kg	Package weight (Kg)	Stock
BT40	BT40-KAG30-195	195	44	86	65	37.5	66	70	65	96	75	1:1	Normal rotation	4,000	BT/NT30	7.2	14.0	●
BT50	BT50-KAG40-230	230	57	88	85	46.5	89	94	80	114	93	1:1	Normal rotation	3,000	BT/NT40	15.7	28.1	●

(Unit : mm)

Chuck

Arbor/Modular

Boring tool

Angular head

CBN/PCD

TAUMAX

Other

1:1 CHAT



BT-HRAG

Attachment type HRAG (Reinforced type) / Attachment-type angular head



Features of HRAG

HRAG that improves the rigidity of the attachment-type bracket by 200%

- Provides stable operation of the face mill cutter
- Enhances compatibility with the machining device due to easy bracket disassembly/assembly even on the BT50 shank
- Improves product life cycle



HRAG (rigidity-reinforced type) features and comparison with KAG

HRAG

KAG

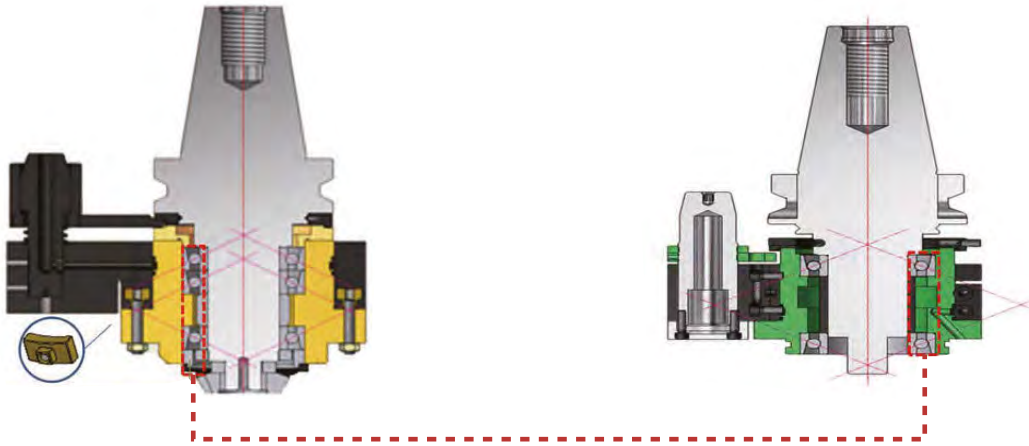

	KHU	HRAG	HRAG Advantages
Joint Type	Bolt	T-nut	Torsional strain improvement
Bearing	2pcs	3pcs	



BT-HRAG

Attachment type HRAG (Reinforced type) / Attachment-type angular head

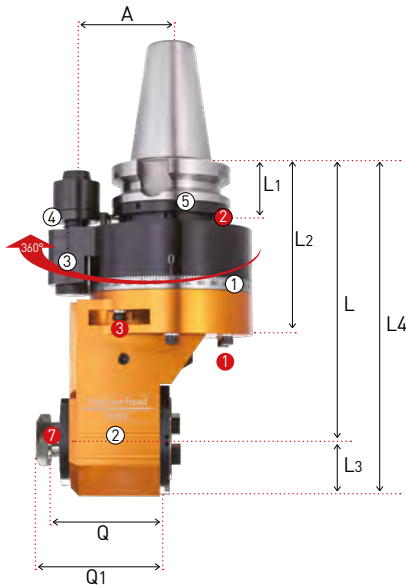

Position pin

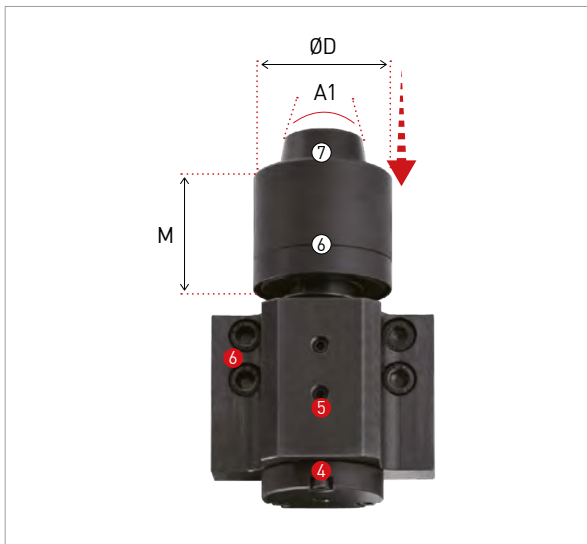

Shank size	M	A1	ØD
BT50	56.5	20°	Ø40

NO	Name
①	Rotation angle split-gradation (360°)
②	Head
③	Position pin block
④	Jaw key
⑤	Position fix ring
⑥	Position pin cover
⑦	Position pin

NO	Parts name	Designation
①	Head angle fix bolt	BX0660
②	Jaw fix screw	MSST5-12
③	Rotation angle split gradation screw	BT0648
④	Position pin height adjustment screw	BT0516
⑤	Position pin height fix screw	BT0512
⑥	Body position block fix screw	BX0516
⑦	BT / NT bolt	

● : Stock

C This product does not support the internal coolant system

• For more information on positioning block, see **241p**

Designation	L	L1	L2	L3	L4	Q	Q1	A	G	G1	MAX RPM	Mounting tool shank	Kg	Stock
BT50 BT50-HRAG40-230	230	56.5	145	47	277	89	101	80	93	136	3,000	BT/NT 40	18.2	●

(Unit : mm)

Chuck

Arbor/Modular

Boring tool

Angular head

CBN/PCD

TAUMAX

Other

1:1 CHAT



BT-KAH

Modular type KAH (90° type) / Fixed angle-type angular head



Features of KAH

Adjustable angle-type angular head that enables flexible machining

- Adjusting angle up to 360°
- To use Tap-exclusive Collet, please contact us in advance
- HSK and SK types are customizable

BT-30 KAH Features

- A small angular head for small equipment (BT30)
- Light weight of 2.6 KG for easy installation
- Available multi-surface processing
- Its processing angle can be freely adjusted by 360° on both sides
- ER11 size collet applied



Structure (Rotation)

- Uses spiral bevel gear (with axial angle of 90°)
- Reduced vibration and noise
- Small backlash
- Thanks to the use of a 1:1 gear ratio, can use without complex calculations
- Reverse-rotation direction compared to spindle (CW:CCW)

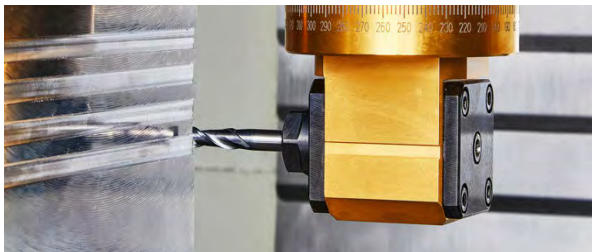

Coolant

- ATC (automatic tool change) available
- The tool turns in the opposite direction of the spindle
- Do not inject cutting oil direct to the angular head body

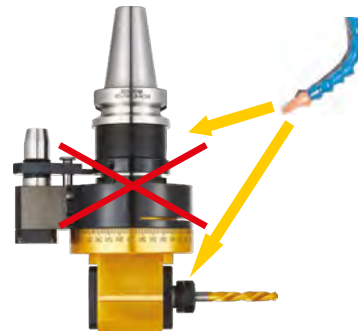

Machining Example

Model : BT50-KAH20-200

Cutting tool	Workpiece	Machining depth	RPM	Feed (mm/min)	Feed (mm/rev)	BT50-KAH20-200
Ø16-2 Flut Endmill(HSS), Over length-40mm	S45C	3	700	98	0.07	
	S45C	4	500	60	0.06	
	AL	7	900	72	0.04	
	AL	4	1800	144	0.04	

SPARE PART	Angular head	Main Components		For separate purchase	Positioning Block
		Nut	Spanner	GERC Collet	Positioning block
	KAH7	R11-AH	S-17	GERC11-ØD	
	KHU10	R16-AH(M20)	S-25	GERC16-ØD	
	KAH13	RU20-AH	35-38	GERC20-ØD	
	KHU20	RU32-AH	48-52	GERC32-ØD	



BT-KAH

Modular type KAH (90° type) / Fixed angle-type angular head



Position pin

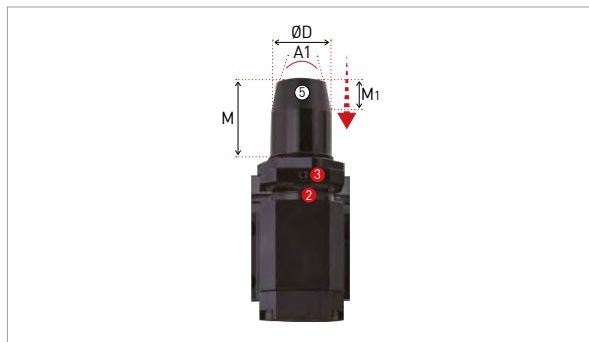

Shank Model No.	M	M1	A1	ØD
BT30	Max : 23 / Min : 17	8	20°	Ø15
BT40	Max : 32 / Min : 26	10	20°	Ø19.6
BT50	Max : 35 / Min : 29	15	20°	Ø28

NO	Name
①	Head
②	Rotation angle split-gradation (360°)
③	Position fix pin block
④	Jaw key
⑤	Height adjusting wrench hole

NO	Parts name	Designation	
①	Head angle fix bolt	BX0618	BT40,BT50
②	Set screw	BTF0404	BT30,BT40,BT50
③	Position pin height fix bolt	SBX0630	BT40,BT50

● : Stock

C This product does not support the internal coolant system

- For more information on the applicable collet, see **96p**.
- For more information on positioning block, see **240p**.

	Designation	ØD	L	L1	L2	L3	L4	L5	L6	B	A	P	Q	G	G1	Gear ratio	MAX RPM	Collet	Kg	Stock
BT30	BT30-KAH7-120	1.0~7.0	120	20	56	39	25	20	140	19	55	37	24.5	40	72	1:1	5,000	GERC11	2.6	●
BT40	BT40-KAH7-170	1.0~7.0	170	20	44	71	55	20	190	19	65	37	24.5	40	96	1:1	5,000	GERC11	5.8	●
	BT40-KAH10-195	1.0~10.0	195	25	44	71	80	25	220	28	65	46	32	58	96	1:1	5,000	GERC16	6.2	●
	BT40-KAH13-165	1.0~13.0	165	28	44	71	50	28	193	35	65	53	35	60	96	1:1	5,000	GERC20	6.0	●
	BT40-KAH20-180	2.0~20.0	180	38	44	71	65	38	218	50	65	71	49	76	96	1:1	3,500	GERC32	7.5	●
BT50	BT50-KAH07-220	1.0~7.0	220	20	57	54	109	20	240	19	80	37	24.5	40	96	1:1	3,500	GERC11	10.7	●
	BT50-KAH10-215	1.0~10.0	215	25	57	54	104	25	240	28	80	46	32	58	96	1:1	3,500	GERC16	11.0	●
	BT50-KAH10-260	1.0~10.0	260	25	57	54	149	25	285	28	80	46	32	58	96	1:1	3,500	GERC16	11.4	●
	BT50-KAH13-260	1.0~13.0	260	28	57	54	149	28	288	35	80	53	35	60	96	1:1	3,500	GERC20	12.0	●
	BT50-KAH20-200	2.0~20.0	200	38	57	54	89	38	238	50	80	71	49	76	96	1:1	3,500	GERC32	11.6	●
	BT50-KAH20-240	2.0~20.0	240	38	57	54	129	38	278	20	80	71	49	76	96	1:1	3,500	GERC32	13.5	●

(Unit : mm)

Chuck

Arbor/Modular

Boring tool

Angular head

cBN/PCD

TAUMAX

Other

1:1 CHAT



BT-KAC

Modular type KAC (45° type) / Fixed angle-type angular head



Features of KAC

Fixed angle type angular head that enables flexible machining

- Adjusting angle up to 360°
- To use Tap-exclusive Collet, please contact us in advance
- 45-degree fixed type angular head
- For BT40 types, please contact us separately



Precautions

Do not inject cutting oil direct to the angular head body.

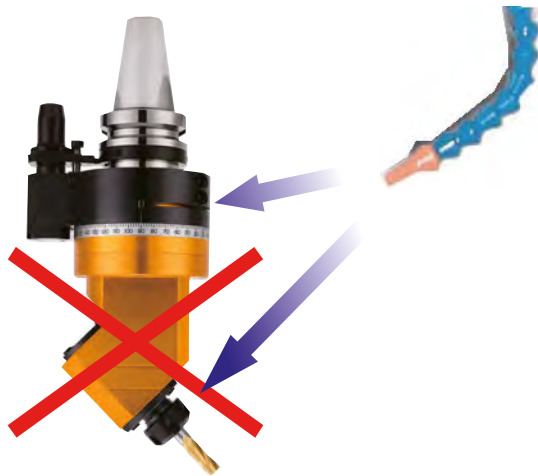

Be sure to give a slope to the cutting edge of a ball end mill when machining it as the ball end mill edge is worn out and the surface roughness of the workpiece becomes defective.

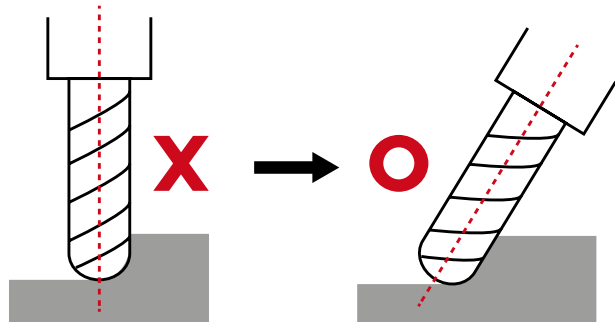

※ To order nuts, please contact us in advance.

SPARE PART	Chuck	Main Components		Components Not Included
		Nut	Spanner	GERC Collet
	KAC10	R16-AH (M20)	S-25	GERC16-ØD
	KAC10	RU20-AH	35-38	GERC20-ØD
	KAC20	RU32-AH	48-52	GERC32-ØD



BT-KAC

Modular type KAC (45° type) / Fixed angle-type angular head

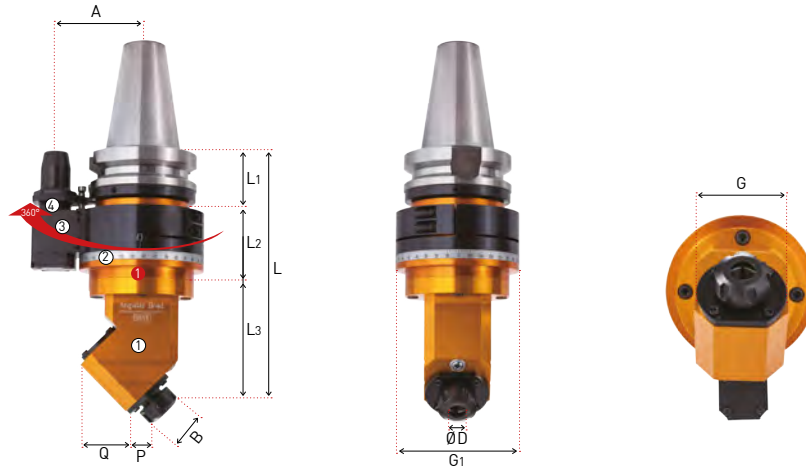

Positioning pin

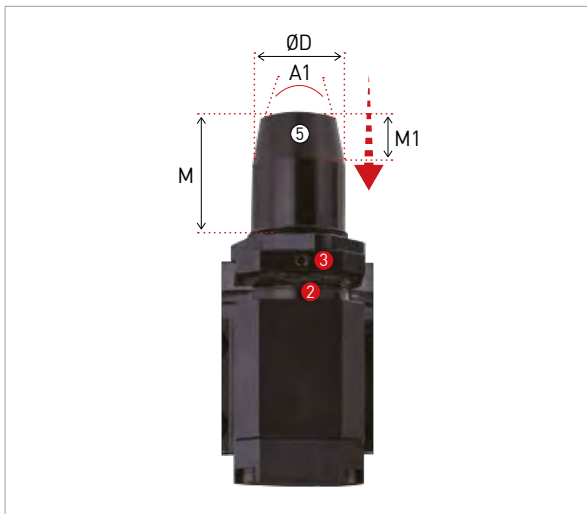

Shank Model No.	M	M1	A1	ØD
BT40	Max : 32 / Min : 26	10	20°	Ø19.6
BT50	Max : 35 / Min : 29	15	20°	Ø28

NO	Name
①	Head
②	Rotation angle split-gradation (360° freely selectable)
③	Positioning pin parts
④	Jaw key
⑤	Height adjusting wrench hole

NO	Parts name	Model No.
①	Head angle fix bolt	BX0618
②	Set screw	BT0404
③	Position pin height fix bolt	BX0630

● : Stock

C This product does not support the internal coolant system

- For more information on the applicable collet, see **96p**.
- For more information on positioning block, see **241p**.

Designation	ØD	L	L1	L2	L3	B	G	G1	P	Q	A	MAX RPM	Applicable collet	Kg	Stock
BT50 BT50-KAC10-240	1.0~10.0	240	57	54	129	28	60	96	25	54	80	5,000	GERC16	9.7	●
BT50-KAC13-240	1.0~13.0	240	57	54	129	28	60	96	25	54	80	5,000	GERC20	10.7	●
BT50-KAC20-250	2.0~20.0	240	57	54	139	50	72	96	30	60	80	3,500	GERC32	11.7	●

(Unit : mm)

Chuck

Arbor/Modular

Boring tool

Angular head

CBN/PCD

TAUMAX

Other



POSITIONING BLOCK

Positioning block (For BT40)

How to install the positioning block on the machine

For BT40

Customer standard type-A group(60°) Standard type-A(60°)

- In case Min. PCD=110mm
- Spindle diameter less than $\varnothing 94$ available
- Keep the minimum distance 55mm between bolts
- In case Max. PCD=135mm
- Spindle diameter less than $\varnothing 112$ available
- Keep the minimum distance 67.5mm between bolts

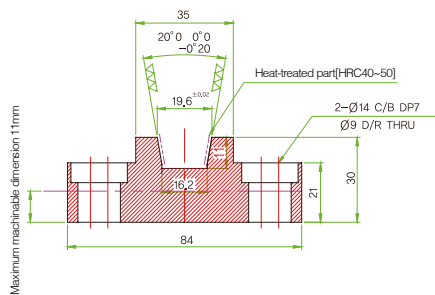
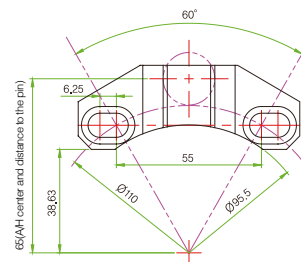
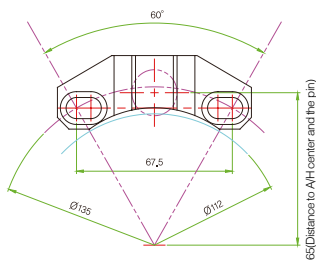

Semi-finishing : Requires block height machining

- The customer must machine the bottom of the block in person to use for use after determining the block height

※ Minimum block height : 19mm (based on the upper side)

- Only the taper part to be heat-treated
- Based on M8 in the case of less than M6, washer supplied

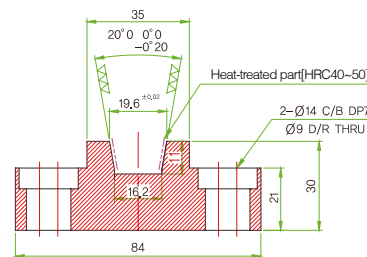
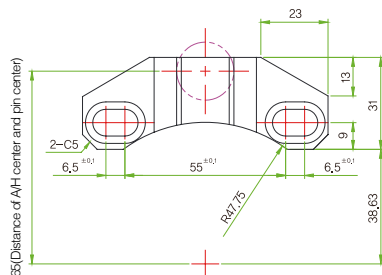

※ DINE Inc, provide the positioning block type by default. (Customer standard type)



POSITIONING BLOCK

Positioning block (For BT50)

How to install the positioning block on the machine

For BT50

Customer standard type-A group(60°) Standard type-A(60°)

- In case Min. PCD = 155
- Spindle diameter less than $\varnothing 130$ available
- Keep the minimum distance 77.5mm between bolts

- In case Max. PCD = 235
- Spindle diameter less than $\varnothing 148$ available
- Keep the minimum distance 117.5mm between bolts

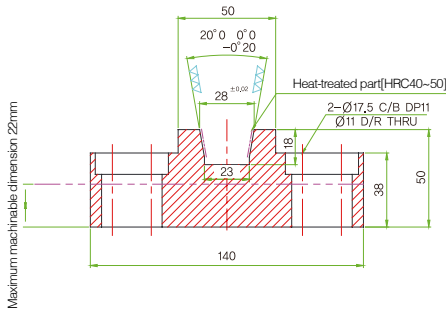
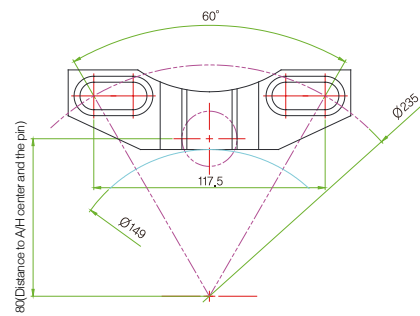
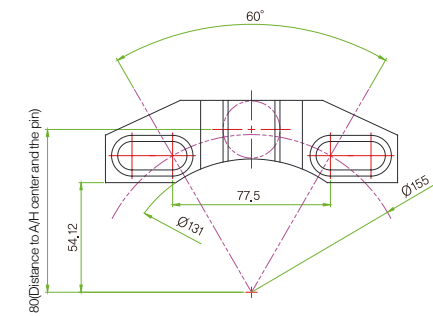

Semi-finishing : Requires block height machining

- The customer should machine the bottom of the block him/herself for use after determining the block height to

※ Minimum block height : 28mm (based on the upper side)

- Only the taper part to be heat-treated
- Based on M10; in the case of less than M8, washer supplied

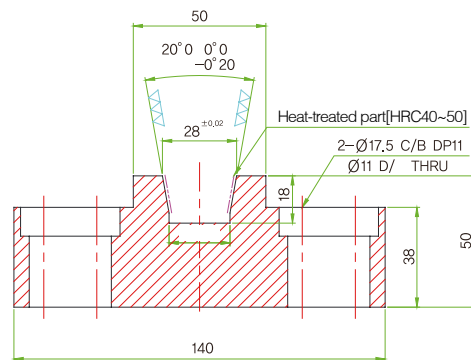
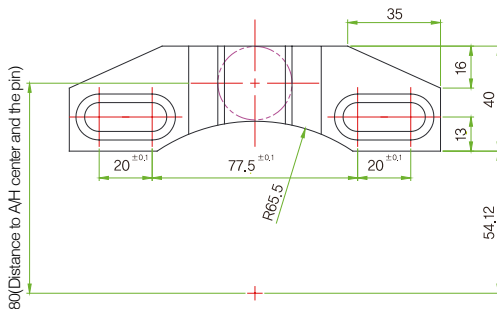

※ DINE Inc, provide the positioning block type by default. (Customer standard type)

Chuck

Arbor/Modular

Boring tool

Angular head

CBN/PCD

TAUMAX

Other

1:1 CHAT



ATM

Air Turbine Machine



Features

- Used for low-slotting high-transfer processing of small tools, and is able to reduce the processing time by around 30% compared to normal processing
- Since it generates almost no heat, long-term processing is possible without rest time
- Even if a processing load occurs and the spindle stops, no problem occurs in ATM
- Super-precision compressed air driving spindle technology is applied

NAMING

BT50	ATM	6	228	[ATC]
Spindle	Air Turbine Machine	Tool dia.	Length	ATC : Auto Tool Change Type NON : General



What is ATM?

The air spindle is able to rotate at a high speed (50,000 RPM) using compressed air, and realize performance the same as that of a high-speed processor even in a standard (conventional) machining center.

Thermal Deformation Protection

- It prevents an increase in temperature of the spindle using an air blade rotation method
- Prevents the deformation of the Z-axis by thermal deformation of the spindle

Z-axis change with rotation time

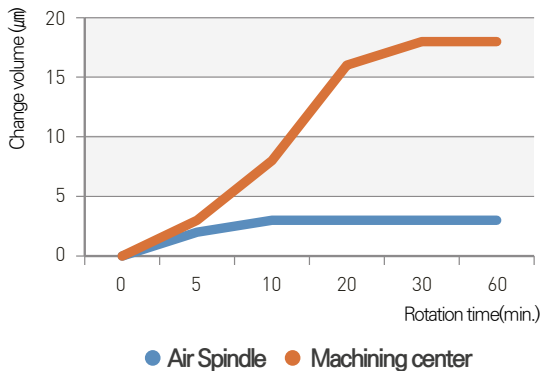

Structure

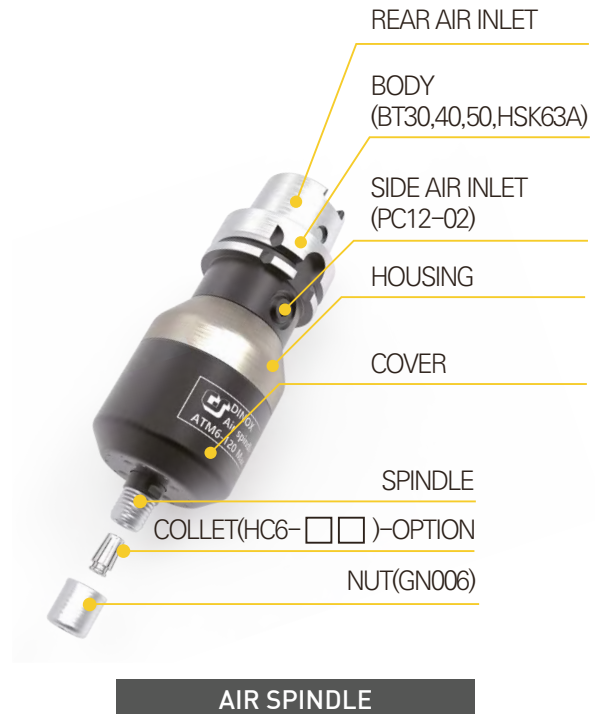



ATM

Air Turbine Machine



Chuck

Arbor/Modular

Boring tool

Angular head

CBN/PCD

TAUMAX

Other

General Type



How to use

- Use in an equipment able to spray air on the main axis
- Able to perform ATC as there is no external air hose to be connected

Precautions

- When spraying the air on the main axis, be careful about introduction of foreign



How to use

- Connect an external air hose
- Connect it directly to the regulator and minimize the introduction of foreign substances

Precautions

- Must separate the hose from the product in case of ATC
- Be careful when the main axis rotates

Auto Tool Change Type

How to use

- It is able to perform ATC and equipment rotation even on equipment with no air main
- The air is supplied on the Positioning Block, so ATC and equipment spindle rotation is possible
- The main axis can rotate at a low-speed, and the tool length can be corrected



Processing Test

Air spindle has a shank and a body in a prefabricated shape, so the shank (BT30, 40, 50, HSK63A) can be easily

Equipment	Air Spindle [HSK63A-ATM6-170]	Machining Center [Hydraulic Chuck]
Processing materials	SCM440 (Hrc 40)	SCM440 (Hrc 40)
Rotation speed	50,000 RPM	20,000 RPM
Processing time	146 min.	276 min.
Axial-directional displacement	5 μ m	21 μ m
Processed surface		
Note	Improved processing speed and surface roughness	Lowered surface roughness and tool life



BT-ATM

Air Turbine Machine

50,000

5 μ m

C

3mm
~6mmGeneral - 2Bar
ATC-2.5Bar

0.47

HC

Max RPM

Run-out
(based on spindle)

Coolant System

Collet size

Air Pressure

Power(HP)

HC collet

Air Spindle General Type

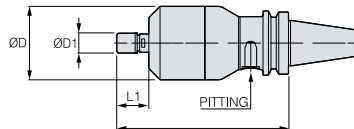

- For more information on the product features, see [242p](#).
- For more information on the related parts, see [246p](#).
- For more information on the applicable collet, see [118p](#).

C This product does not support the internal coolant system

	Designation	ØD	ØD1	L	L1	RPM (based on 2 bar of regulator)	Pitting	Stock
BT30	BT30-ATM6-176	72	19.5	176	31.5	MAX.50,000	PC12-02	
BT40	BT40-ATM6-171	72	19.5	171	31.5	MAX.50,000	PC12-02	
BT50	BT50-ATM6-182	72	19.5	182	31.5	MAX.50,000	PC12-02	

(Unit : mm)

Air Spindle ATC Type

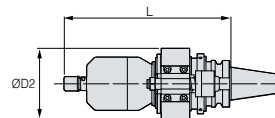
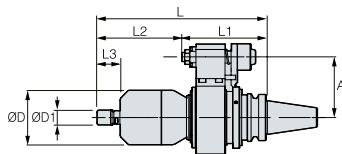

- For more information on the product features, see [242p](#).
- For more information on the related parts, see [246p](#).
- For more information on the applicable collet, see [118p](#).

C This product does not support the internal coolant system

	Designation	ØD	ØD1	ØD2	L	L1	L2	L3	A	RPM (based on 2 bar of regulator)	Stock
BT40	BT40-ATM6-227(ATC)	72	19.5	96	227	114	113	32	80	MAX.50,000	
BT50	BT50-ATM6-228(ATC)	72	19.5	96	228	115	113	32	80	MAX.50,000	

(Unit : mm)



HSK-ATM

Air Turbine Machine

50,000	5 μ m	C	1mm ~6mm	General - 2Bar ATC-2.5Bar	0.47	HC
Max RPM	Run-out (based on spindle)	Coolant System	Collet size	Air Pressure	Power(HP)	HC collet

Air Spindle General Type

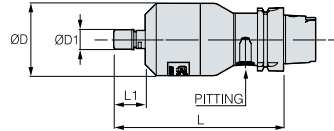

- For more information on the product features, see [242p](#).
- For more information on the related parts, see [246p](#).
- For more information on the applicable collet, see [118p](#).

C This product does not support the internal coolant system

Designation	ØD	ØD1	L	L1	RPM (based on 2 bar of regulator)	Pitting	Stock
HSK63A HSK63A-ATM6-170	72	19.5	170	31.5	MAX.50,000	PC12-02	

(Unit : mm)

Air Spindle ATC Type

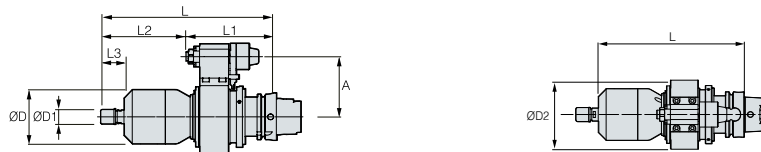

- For more information on the product features, see [242p](#).
- For more information on the related parts, see [246p](#).
- For more information on the applicable collet, see [118p](#).

C This product does not support the internal coolant system

Designation	ØD	ØD1	ØD2	L	L1	L2	L3	A	RPM (based on 2 bar of regulator)	Stock
HSK63A HSK63A-ATM6-235(ATC)	72	19.5	96	235	122	113	32	80	MAX.50,000	

(Unit : mm)



ATM SPARE PART





Air Turbine Machine related parts

SPARE PART



SPARE PART



Main components

Images					
Components	AIR SPINDLE	AIR REGULATOR	BX0310	SPANNER	NUT
Quantity	1	1	2	1	1

Type	AIR SPINDLE				
Spec	ATM6 (BT50,40,30,HSK63A)				
ATM components.	No	Classification	Name	Designation	Quantity(EA)
	1	BASIC	ATM6	□□□-ATM6-□□□	1
	2	BASIC	NUT	GN-06	1
	3	BASIC	REGULATOR	TPC PP3-03BG	1
	4	BASIC	PITTING	PC12-02	1
	5	BASIC		PC12-03	2
	6	BASIC	SPANNER	GSK6-SPANNER	1
	7	BASIC		S16 SPANNER	1

For separate purchase

SPARE PART

Designation	Images	ØD1	L	MAX. ØD	Distance	Positioning Block
HC6ØD(P)		10.5	25.0	6.0	1.0	



cBN/PCD

DINOX NC TOTAL TOOLING SYSTEM

How to indicate the model no. of insert (ISO)	248
cBN Spec	250
PCD Spec	254
cBN Features	256
cBN Heat-treat steel	260
cBN Cast iron	266
cBN Sinter Alloy	268
DNC100	270
DNC250	271
DNC300	272
DNC350	273
DB1000	274
DB2000	275
DB7000	276
DB7500	277
RA,GA Chip Breaker	278
cBN Technical data	279
cBN Edge treatment	283
cBN Re-grinding	287
PCD Chip Breaker(UC)	288
PCD Technical data	289



How to indicate the model no. of insert (ISO)

C

N

G

M

1

2

3

4

Insert shape

Major clearance angle

Tolerance

Cross-sectional shape

1 Insert shape

C N G M 12 04 08 - VM

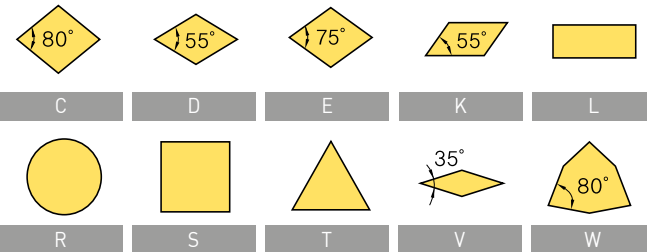

2 Major clearance angle

C **N** G M 12 04 08 - VM

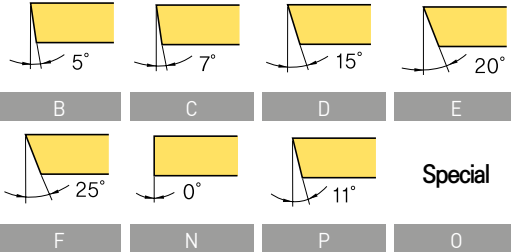

3 Tolerance

C N **G** M 12 04 08 - VM

d : Diameter of inscribed circle
t : Insert thickness
m : Refer to the figure

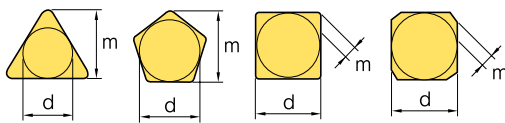

Class	d	m	t
A	±0.025	±0.005	±0.025
C	±0.025	±0.013	±0.025
H	±0.013	±0.013	±0.025
E	±0.025	±0.025	±0.025
G	±0.025	±0.025	±0.13
J*	±0.05 ~ ±0.15	±0.005	±0.025
K*	±0.05 ~ ±0.15	±0.013	±0.025
L*	±0.05 ~ ±0.15	±0.025	±0.025
M*	±0.05 ~ ±0.15	±0.08 ~ ±0.20	±0.13
N*	±0.05 ~ ±0.15	±0.08 ~ ±0.18	±0.025
U*	±0.08 ~ ±0.25	±0.13 ~ ±0.38	±0.13

* Side is the one of the sintered parts

Tolerance definition of C, H, R, T, and W types of inscribed circle (Exceptions)

d	Tolerance of d		Tolerance of m	
	J, K, L, M, N	U	M, N	U
6.35	±0.05	±0.08	±0.08	±0.13
9.525	±0.05	±0.08	±0.08	±0.13
12.7	±0.08	±0.13	±0.13	±0.20
15.875	±0.10	±0.18	±0.15	±0.27
19.05	±0.10	±0.18	±0.15	±0.27
25.4	±0.13	±0.25	±0.18	±0.38

Tolerance definition of D-type inscribed circle (Exceptions)

d	Tolerance of d	Tolerance of m
6.35	±0.05	±0.11
9.525	±0.05	±0.11
12.7	±0.08	±0.15
15.875	±0.10	±0.18
19.05	±0.10	±0.18

4 Cross-sectional shape

C N G **M** 12 04 08 - VM

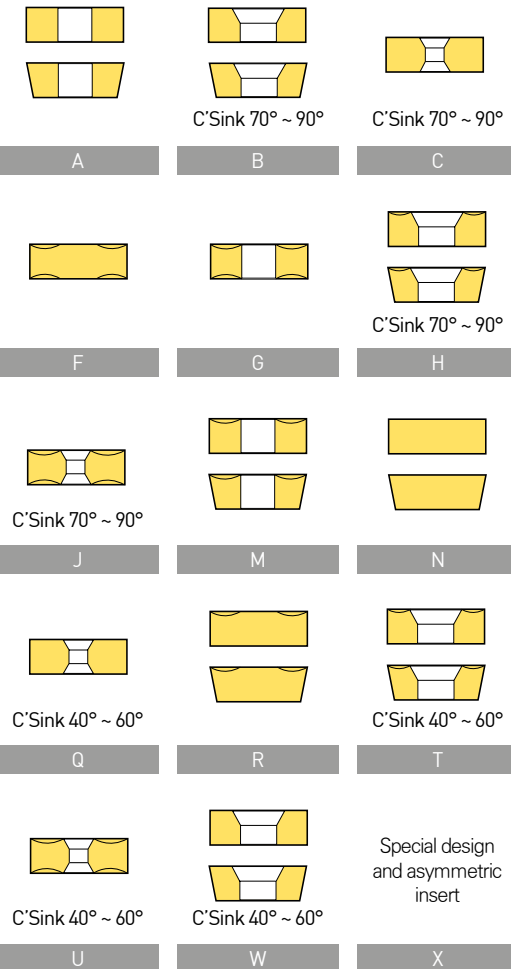



How to indicate the model no. of insert (ISO)

12

04

08

GA

5

6

7

8

Cutting edge length,
Inscribed circle diameter

Cutting edge height

Nose "r" size

Chip breaker

5

Cutting edge length, Inscribed circle diameter

C N G M 12 04 08 - GA

() small symbols

Symbols							Inch	IC
								d(mm)
03	04	03	06	03	-	02	1.2(5)	3.97
04	05	04	08	04	08	S3	1.5(6)	4.76
05	06	05	09	05	09	03	1.8(7)	5.56
-	-	-	-	06	-	-	-	6.00
06	07	06	11	06	11	04	2	6.35
08	09	07	13	07	13	05	2.5	7.94
-	-	-	-	08	-	-	-	8.00
09	11	09	16	09	16	06	3	9.525
-	-	-	-	10	-	-	-	10.00
11	13	11	19	11	19	07	3.5	11.11
-	-	-	-	12	-	-	-	12.00
12	15	12	22	12	22	08	4	12.70
14	17	14	24	14	24	09	4.5	14.29
16	19	15	27	15	27	10	5	15.875
-	-	-	-	16	-	-	-	16.00
17	21	17	30	17	30	11	5.5	17.46
19	23	19	33	19	33	13	6	19.05
-	-	-	-	20	-	-	-	20.00
22	27	22	38	22	38	15	7	22.225
-	-	-	-	25	-	-	-	25.00
25	31	25	44	25	44	17	8	25.40
32	38	31	54	31	54	21	10	31.75
-	-	-	-	32	-	-	-	32.00

6

Cutting edge height

C N G M 12 04 08 - GA

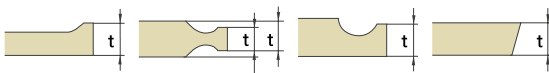

Metric	Symbol		Nose "r"	
	Inch	M, N	Inch	
01	1(2)	1.59	1/16	
T0	1.125	1.79	9/128	
T1	1.2	1.98	5/64	
02	1.5(3)	2.38	3/32	
T2	1.75	2.78	7/64	
03	2	3.18	1/8	
T3	2.5	3.97	5/32	
04	3	4.76	3/16	
05	3.5	5.56	7/32	
06	4	6.35	1/4	
07	5	7.94	5/16	
09	6	9.52	3/8	
11	7	11.11	7/16	
12	8	12.70	1/2	

() small symbols

7

Nose "r" size

C N G M 12 04 08 - GA



Symbol		Nose "r"	
Metric	Inch	M, N	Inch
01	0	0.1	0.004
02	0.5	0.2	0.008
04	1	0.4	1/64
08	2	0.8	1/32
12	3	1.2	3/64
16	4	1.6	1/16
20	5	2.0	5/64
24	6	2.4	3/32
28	7	2.8	7/64
32	8	3.2	1/8
00	-	Circular insert (Inch type)	
M0	-	Circular insert (Metric type)	

8

Chip breaker

C N G M 12 04 08 - GA

cBN Rough-boring 	Fine-boring 	PCD General-purpose
RA	GA	UC



cBN Spec

cBN Multi-corner type (Negative/positive)

※ T-2NU-□□□□△△△△△△△△△△ model no. package unit is 10 EA.

● : Stock

Drawing	Designation	Grade										W (Weight)	mm					
		DNC100	DNC250	DNC300	DNC350	DNC400	DB1000	DB2000	DBN250	DBN350	DBN700A		DBNX20	S (cutting edge length)	IC (inscribed circle)	T (Thickness)	R (Nose R)	ØD (hole diameter)
	2NU-CNGA120404	●	●	●	●	-	●	-	-	-	●	-	9.9	2.7	12.7	4.76	0.4	5.16
	2NU-CNGA120404F	-	●	-	●	-	-	-	-	-	-	-	9.9	2.7	12.7	4.76	0.4	5.16
	2NU-CNGA120404T	-	●	-	●	-	●	-	-	-	-	-	9.9	2.7	12.7	4.76	0.4	5.16
	2NU-CNGA120404W	-	●	-	-	-	-	-	-	-	-	-	9.9	2.7	12.7	4.76	0.4	5.16
	2NU-CNGA120404WF	-	●	-	-	-	-	-	-	-	-	-	9.9	2.7	12.7	4.76	0.4	5.16
	2NU-CNGA120408	●	●	●	●	-	●	●	-	-	●	-	9.9	2.6	12.7	4.76	0.8	5.16
	2NU-CNGA120408F	-	●	-	●	-	-	-	-	-	-	-	9.9	2.6	12.7	4.76	0.8	5.16
	2NU-CNGA120408T	-	●	-	●	-	●	-	-	-	-	-	9.9	2.6	12.7	4.76	0.8	5.16
	2NU-CNGA120408W	-	●	-	●	-	●	-	-	-	●	-	9.9	2.6	12.7	4.76	0.8	5.16
	2NU-CNGA120408WF	-	-	-	-	-	-	●	-	-	-	-	9.9	2.6	12.7	4.76	0.8	5.16
	2NU-CNGA120412	●	●	●	●	-	-	-	-	-	-	-	9.9	2.6	12.7	4.76	1.2	5.16
	2NU-CNGA120412F	-	●	-	●	-	-	-	-	-	-	-	9.9	2.6	12.7	4.76	1.2	5.16
	2NU-CNGA120412T	-	●	-	●	-	-	-	-	-	-	-	9.9	2.6	12.7	4.76	1.2	5.16
	2NU-CNGA120412W	-	●	-	-	-	-	-	-	-	●	-	9.9	2.6	12.7	4.76	1.2	5.16
	2NU-CNGA120412WT	-	-	-	-	-	●	-	-	-	-	-	9.9	2.6	12.7	4.76	1.2	5.16
	T-2NU-CNGA120404	-	●	-	-	-	-	-	-	-	-	-	9.9	2.7	12.7	4.76	0.4	5.16
T-2NU-CNGA120408	-	●	-	●	-	-	-	-	-	-	-	9.9	2.6	12.7	4.76	0.8	5.16	
	4NU-CNGA120404	-	●	-	-	-	-	-	-	-	-	9.9	2.7	12.7	4.76	0.4	5.16	
	4NU-CNGA120408	-	●	-	●	-	-	-	-	-	-	9.9	2.6	12.7	4.76	0.8	5.16	
	4NU-CNGA120412	-	●	-	-	-	-	-	-	-	-	9.9	2.6	12.7	4.76	1.2	5.16	
	2NU-DNGA150404	-	●	●	●	-	-	●	●	-	-	12.3	2.6	12.7	4.76	0.4	5.16	
	2NU-DNGA150404F	-	●	-	●	-	-	-	-	-	-	12.3	2.6	12.7	4.76	0.4	5.16	
	2NU-DNGA150404T	-	●	-	●	-	-	-	-	-	-	12.3	2.6	12.7	4.76	0.4	5.16	
	2NU-DNGA150408	-	●	●	●	-	●	●	●	-	-	12.3	2.2	12.7	4.76	0.8	5.16	
	2NU-DNGA150408F	-	●	-	●	-	-	-	-	-	-	12.3	2.2	12.7	4.76	0.8	5.16	
	2NU-DNGA150408T	-	●	-	●	-	-	-	-	-	-	12.3	2.2	12.7	4.76	0.8	5.16	
	2NU-DNGA150412	-	●	-	●	-	●	●	-	-	-	12.3	2.5	12.7	4.76	1.2	5.16	
	2NU-DNGA150412F	-	●	-	●	-	-	-	-	-	-	12.3	2.5	12.7	4.76	1.2	5.16	
	2NU-DNGA150412T	-	●	-	●	-	-	-	-	-	-	12.3	2.5	12.7	4.76	1.2	5.16	
	2NU-DNGA150604	●	●	-	●	-	-	-	-	-	-	15.4	2.5	12.7	6.35	0.4	5.16	
2NU-DNGA150608	●	●	-	●	-	-	-	-	-	-	15.4	2.5	12.7	6.35	0.8	5.16		
	4NU-DNGA150404	-	●	-	●	-	-	-	-	-	-	12.3	1.8	12.7	4.76	0.4	5.16	
	4NU-DNGA150408	-	●	-	●	-	-	-	-	-	-	12.3	2.9	12.7	4.76	0.8	5.16	
	4NU-DNGA150412	-	●	-	●	-	-	-	-	-	-	12.3	3	12.7	4.76	1.2	5.16	
	4NU-DNGA150608	-	●	-	-	-	-	-	-	-	-	15.4	2.9	12.7	6.35	0.8	5.16	
	4NU-SNGA120404	-	●	-	-	-	-	-	-	●	-	9.9	3.1	12.7	4.76	0.4	5.16	
	4NU-SNGA120408	-	●	-	-	-	-	-	-	●	-	9.9	3.1	12.7	4.76	0.8	5.16	
	3NU-TNGA160404	-	●	-	●	-	●	●	-	●	-	7.2	2.5	9.53	4.76	0.4	3.81	
	3NU-TNGA160404T	-	●	-	-	-	-	-	-	-	-	7.2	2.5	9.53	4.76	0.4	3.81	
	3NU-TNGA160408	-	●	-	●	-	-	-	-	●	-	7.2	2.3	9.53	4.76	0.8	3.81	
	3NU-TNGA160408F	-	●	-	-	-	-	-	-	-	-	7.2	2.3	9.53	4.76	0.8	3.81	
	3NU-TNGA160408T	-	●	-	-	-	-	-	-	-	-	7.2	2.3	9.53	4.76	0.8	3.81	
	3NU-TNGA160412	-	-	-	●	-	-	-	-	-	-	7.2	2.0	9.53	4.76	1.2	3.81	



cBN Spec

cBN Multi-corner type (Negative/positive)

※ T-2NU-□□□□△△△△△△△△ model no. package unit is 10 EA.

● : Stock ○ : Will be discontinued

Drawing	Designation	Grade											W (Weight)	mm				
		DNC100	DNC250	DNC300	DNC350	DNC400	DB1000	DB2000	DBN250	DBN350	DBN700A	DBNX20		S (cutting edge length)	IC (inscribed circle)	T (Thickness)	R (Nose R)	∅D (hole diameter)
	3NU-TPGB110304	-	○	-	-	-	-	-	○	-	-	-	2.0	2.5	6.35	3.18	0.4	3.4
	3NU-TPGB110304T	-	○	-	-	-	-	-	-	-	-	-	2.0	2.5	6.35	3.18	0.4	3.4
	3NU-TPGB110308	-	○	-	-	-	-	-	-	-	-	-	2.0	2.3	6.35	3.18	0.8	3.4
	3NU-TPGB110308F	-	○	-	-	-	-	-	-	-	-	-	2.0	2.3	6.35	3.18	0.8	3.4
	3NU-TPGB110308T	-	○	-	-	-	-	-	-	-	-	-	2.0	2.3	6.35	3.18	0.8	3.4
	2NU-VBGW160402	-	●	-	-	-	-	-	-	-	-	8.6	3.5	9.53	4.76	0.2	4.4	
	2NU-VBGW160404	●	●	-	●	-	●	-	●	-	●	8.6	3.5	9.53	4.76	0.4	4.4	
	2NU-VBGW160404F	-	●	-	-	-	-	-	-	-	-	8.6	3.5	9.53	4.76	0.4	4.4	
	2NU-VBGW160404T	-	●	-	-	-	-	-	-	-	-	8.6	3.5	9.53	4.76	0.4	4.4	
	2NU-VBGW160408	●	●	-	●	-	-	●	●	-	-	8.6	2.6	9.53	4.76	0.8	4.4	
	2NU-VBGW160408F	-	●	-	-	-	-	-	-	-	-	8.6	2.6	9.53	4.76	0.8	4.4	
	2NU-VBGW160408T	-	●	-	-	-	-	-	-	-	-	8.6	2.6	9.53	4.76	0.8	4.4	
T-2NU-VBGW160408	-	-	-	●	-	-	-	-	-	-	-	8.6	2.6	9.53	4.76	0.8	4.4	
	2NU-VCGW160404	-	●	-	●	-	-	-	-	-	-	8.6	3.5	9.53	4.76	0.4	4.4	
	2NU-VCGW160404F	-	●	-	-	-	-	-	-	-	-	8.6	3.5	9.53	4.76	0.4	4.4	
	2NU-VCGW160404T	-	●	-	-	-	-	-	-	-	-	8.6	3.5	9.53	4.76	0.4	4.4	
	2NU-VCGW160408	-	●	-	-	-	-	-	-	-	-	8.6	2.6	9.53	4.76	0.8	4.4	
	2NU-VCGW160408F	-	●	-	-	-	-	-	-	-	-	8.6	2.6	9.53	4.76	0.8	4.4	
	2NU-VCGW160408T	-	●	-	-	-	●	●	-	-	-	8.6	2.6	9.53	4.76	0.8	4.4	
	T-2NU-VCGW160404	-	●	-	-	-	-	-	-	-	-	8.6	3.5	9.53	4.76	0.4	4.4	
T-2NU-VCGW160408	-	●	-	-	-	-	-	-	-	-	8.6	2.6	9.53	4.76	0.8	4.4		
	CNMA120404	-	-	-	-	-	-	●	-	-	-	9.89	4.5	12.7	4.76	0.4	5.16	
	CNMA120408	-	-	-	-	-	-	●	-	●	-	9.89	4.5	12.7	4.76	0.8	5.16	
	T-CNMA120408	-	-	-	-	-	-	●	-	-	-	9.89	4.5	12.7	4.76	0.8	5.16	
	DNMA150404	-	-	-	-	-	-	●	-	-	-	12.2	3.7	12.7	4.76	0.4	5.16	
	DNMA150408	-	-	-	-	-	-	●	●	-	-	12.2	3.4	12.7	4.76	0.8	5.16	
	TNMA160404	-	-	-	-	-	-	●	-	-	-	7.2	3.7	9.53	4.76	0.4	3.81	
	TNMA160408	-	-	-	-	-	-	●	-	-	-	7.2	3.5	9.53	4.76	0.8	3.81	
	T-VNMA160404	-	-	-	-	-	-	●	-	-	-	10.2	4.9	9.53	4.76	0.4	3.81	
	VNMA160404	-	-	-	-	-	-	●	-	-	-	10.2	5.8	9.53	4.76	0.4	3.81	
	VNMA160408	-	-	-	-	-	-	●	-	-	-	10.2	5.8	9.53	4.76	0.8	3.81	
	CCMW09T304	-	-	-	-	-	-	●	-	-	-	4.5	4.3	9.53	3.97	0.4	4.4	



PCD Spec

PCD Insert (Negative/positive)

※ T-2NU-□□□□△△△△△△△△ model no. package unit is 10 EA.

● : Stock

Drawing	Designation	Grade	W (Weight)	mm					
		DP150		S (cutting edge length)	IC (inscribed circle)	T (Thickness)	R (Nose R)	∅D (hole diameter)	
	CNMM120404	●	9.9	4.3	12.7	4.76	0.4	5.16	
	CNMM120408	●	9.9	4.2	12.7	4.76	0.8	5.16	
	CCMW120404	●	9.8	4.3	12.7	4.76	0.4	5.16	
	DNMM150404	●	12.2	3.5	12.7	4.76	0.4	5.16	
	DNMM150408	●	12.2	3.2	12.7	4.76	0.8	5.16	
	CCMT060202	●	0.9	2.8	6.35	2.38	0.2	2.8	
	CCMT060204	●	0.9	2.7	6.35	2.38	0.4	2.8	
	CCMT09T304	●	3.4	4.3	9.53	3.97	0.4	4.4	
	CCMT09T308	●	3.4	4.2	9.53	3.97	0.8	4.4	
	DCMT070202	●	1.2	3.7	6.35	2.38	0.2	2.8	
	DCMT070204	●	1.2	3.5	6.35	2.38	0.4	2.8	
	DCMT11T302	●	4.5	3.5	9.53	3.97	0.2	4.4	
	DCMT11T304	●	4.5	3.5	9.53	3.97	0.4	4.4	
	DCMT11T308	●	4.5	3.2	9.53	3.97	0.8	4.4	
	DCGT11T304	●	4.5	3.5	9.53	3.97	0.4	4.4	



cBN Features

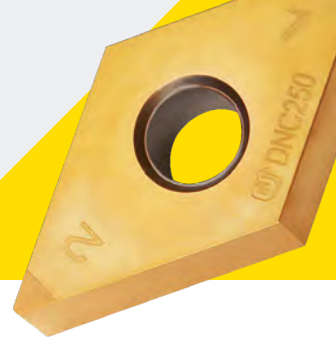

Features

DINOX cBN features very excellent hardness and thermal resistance by adding special ceramic bonding material to cBN, its main ingredient, and sintering them at an ultrahigh-pressure high temperature. It also provides optimal conditions for productivity improvement through high-speed processing of cast iron and heattreated steel due to its excellent strength and wear resistance.

High accuracy

Wear resistance

Productivity improvement



cBN Type

Re-polishing type	One-use type	Multi-corner type	Multi-corner type (coating)	NS Type	NT Type

Re-grinding type

- Stable and long tool life
- Excellent wear resistance, high hardness
- 3-4 time re-polishing is possible, which reduces tool expenses

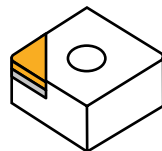

e.g.) CNGA120408

Multi-corner type (coated/non-coated)

- Simple corner management
- Strong welding surface
- Possible to create an effect of several cBNs with one insert



Coated
cBN

Non-coated
cBN

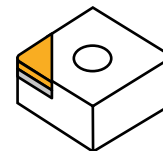

e.g.) 2NU-CNGA120408

NS, NT Type

NS Type

- Specialized high cutting depth
- Excellent machining performance in spite of variable cutting depth

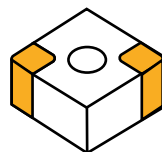
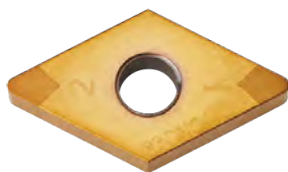

e.g.) 4NS-CNGA120408

NT Type

- High cutting depth versus general brazing type
- Economical cBN

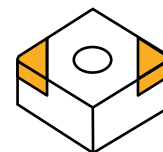
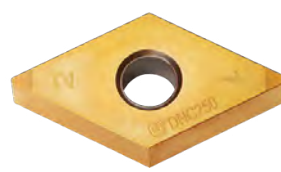

e.g.) 2NT-CNGA120408

※ High cutting depth and high feed available; excellent machining performance in spite of variable cutting depth

※ Universal machining available; stable and efficient machining versus general brazing inserts



cBN Features



Applications by grade and textural characteristics

Textural characteristics	Texture	cBN content	Grade name	Workpiece, Applications	Features
Mostly cBN particles combine by themselves		High ↑	DB7000 DB7500	Cemented carbide alloy, chilled cast iron, Ni-hard cast iron, Iron metal sintered alloy, heat-resistant alloy, cast iron	<ul style="list-style-type: none"> High cBN content and texture where cBN particles strongly combine by themselves Suitable for cutting machining of high-hardness materials such as cast iron, heat-resistant alloy, Cemented carbide alloy, etc.
Mostly cBN particles combine by means of bonding material		Low ↓	DB1000, DB2000, DBN250, DBN350, DBN500, DBNX20, DBNX25, DNC100, DNC250, DNC300, DNC350, DNC400	Alloy steel, titanium steel, carbon tool steel, bearing steel, dice steel, ductile cast iron	<ul style="list-style-type: none"> cBN particles strongly combine by special ceramic bonding material Features excellent wear resistance and tenacity in cutting heat-treated steel due to its high cBN retention capacity

Grade map

Workpiece	Type	High-speed continuous	Continuous	Low/medium interrupted	High interrupted
H Heat-treat steel	Usage classification	H01	H10	H20	H30
	Coated cBN	DNC100		DNC250	DNC300 NEW
	Non-coated cBN	DB1000	DB2000	DBNX20	DBNX25
Sinter Alloy	Usage classification	1	10	20	30
	Non-coated cBN	DB7500	DB7000		
K Cast iron	Usage classification	K01	K10	K20	K30
	Non-coated cBN	DBN500		DB7000	DBNS800
	Non-coated cBN	DB7000		DBNS800	
S Difficult-to-cut materials	Usage classification	S01	S10	S20	S30
	Non-coated cBN	DB7000		DBNS800	

Chuck

Arbor/Modular

Boring tool

Angular head

cBN/PCD

TAUMAX





Other

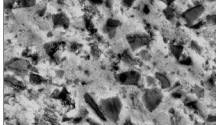
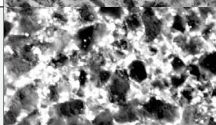

cBN Features

Coating information

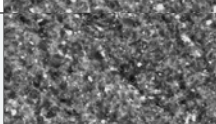
Characteristics

Classification	Grade	Texture	Binder	cBN content (%)	Grain size (μm)	Hardness HV (Gpa)
	DNC100		TiN	50 - 55	2	31 - 34
	DNC250		TiC	65 - 70	6	32 - 34
	^{NEW} DNC300		TiN	65 - 70	4	29 - 31
	DNC350		TiN	60 - 65	1	33 - 35
	DNC400		TiN	65	3	-

Coated thin-film characteristics

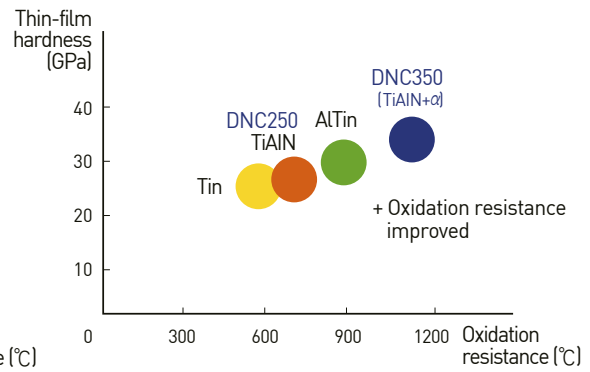
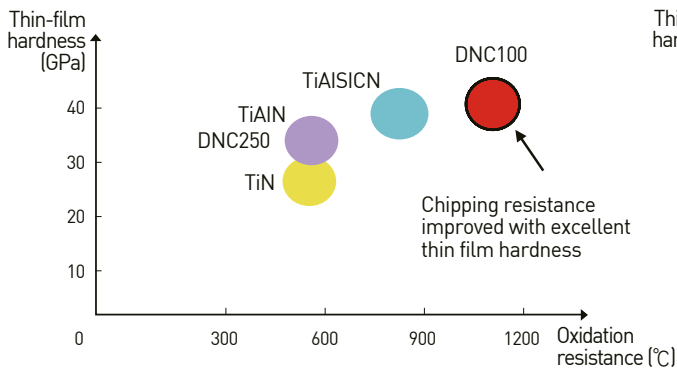







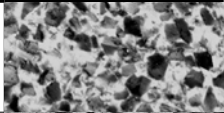
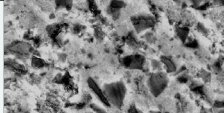
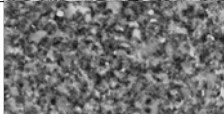
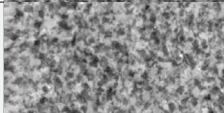
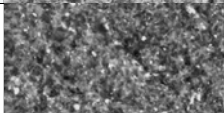
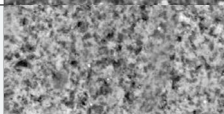

cBN Features

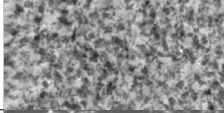
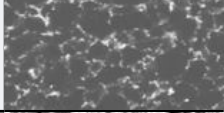
Non-coating information

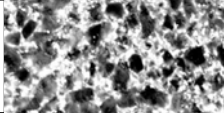
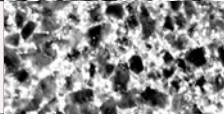
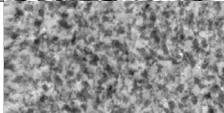
Characteristics

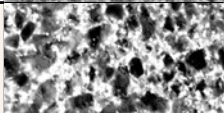
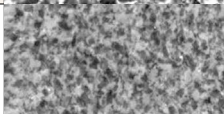
Classification	Grade	Texture	Binder	cBN content (%)	Grain size (μm)	Hardness HV (Gpa)
	DB1000		TiCN	40 - 45	1	27 - 31
	DB2000		TiN	50 - 55	2	31 - 34
	DBNX20		TiN	55 - 60	3	31 - 33
	DBNX25		TiN	65 - 70	4	29 - 31
	DBN250		TiN	50 - 55	2	31 - 34
	DBN350		TiN	60 - 65	1	33 - 35
	DB7000		CO compound	90 - 95	2	41 - 44
	DB7500		CO compound	90 - 95	1	41 - 44
	DBN500		TiC	65 - 70	6	32 - 34
	DBNS800		Al compound	85 - 90	8	39 - 42
	DB7000		CO compound	90 - 95	2	41 - 44
	DBNS800		Al compound	85 - 90	8	39 - 42
	DB7000		CO compound	90 - 95	2	41 - 44

Chuck

Arbor/Modular

Boring tool

Angular head

cBN/PCD

TAUMAX

Other



Features and cutting conditions of cBN grade

Classification	Grade		Insert color	Applications	Cutting conditions								
	Coated or noncoated	Name			Cutting speed Vc(m/min)			Feed f(mm/rev)	Cutting depth ap(mm)				
					0	50	100	150	200	250	300		
	Coated	DNC100	Dark brown	For high-speed, continuous cutting	180			300			0.03 -0.30	0.03 -0.30	
		DNC250	Gold color	For continuous, low interrupted cutting	120			220			0.05 -0.30	0.05 -0.30	
		^{NEW} DNC300	Dark brown	For low/medium interrupted cutting	90			250			0.05 -0.20	0.05 -0.25	
		DNC350	Dark brown	For medium/high interrupted cutting	90			150			0.05 -0.30	0.05 -0.50	
		DNC400	Gold color	For low/medium interrupted cutting	80			200			0.05 -0.30	0.05 -0.50	
	Non-coated	DBNX20			For high efficiency cutting	120			150			0.03 -0.30	0.03 -0.50
		DBNX25			For high-speed interrupted cutting	150			200			0.03 -0.30	0.03 -0.50
		DBN250			For low/medium interrupted cutting	80			120			0.03 -0.20	0.03 -0.30
		DBN350			For high interrupted cutting	80			110			0.03 -0.20	0.03 -0.30
		DB1000			For high-speed, continuous cutting	130			250			0.03 -0.15	0.03 -0.20
		DB2000			For low/medium interrupted cutting	80			200			0.03 -0.20	0.03 -0.30

Comparison of coated and non-coated cBNs

Machining information

Vc(m/min)	f(mm/rev)	ap(mm)	No. of machining ops.	Cutting distance	Workpiece	Heat treated	Hardness	Size
200	0.1	0.1	20 times	6km	SCM415 round rod	Carburizing heat treatment	58-62	Ø105*150

Wear loss (coating superior)

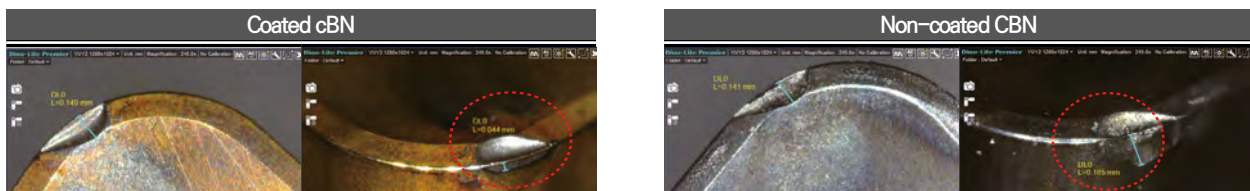

Surface roughness (non-coating superior)

Grade	Surface roughness		
	8 times	12 times	20 times
Non-coated cBN	Ra 0.431	Ra 0.477	Ra 0.492
Coated cBN	Ra 0.579	Ra 0.631	Ra 0.792

※ The details may vary according to machining environments.



cBN Heat-treat steel



Applicable area

- **Coated cBN** : Suitable for all heat-treated steel machining as it is excellent in high-speed high-efficiency machining
- **Non-coated cBN** : Suitable for machining of high-hardness heat-treated steel or parts to which cutting speed is limited

Series	Usable area
Coated cBN	<ul style="list-style-type: none"> • Ideal for heat-treated steel machining • Machining requiring high speed and high precision • Machining requiring high efficiency such as carburized layer removal
Uncoated cBN	<ul style="list-style-type: none"> • Small parts not requiring high cutting speed • Machining materials including much hard particles such as mold parts • Applicable even in case of an unstable machine setup

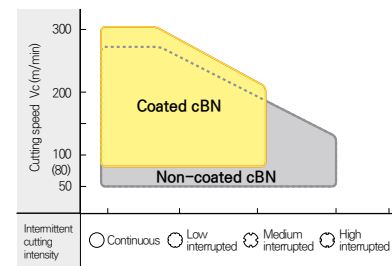

Coated cBN

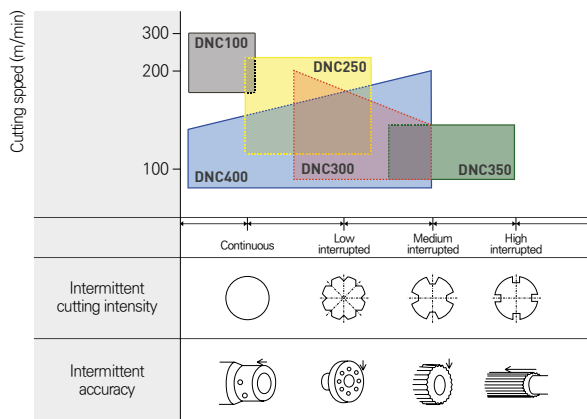

Non-coated cBN

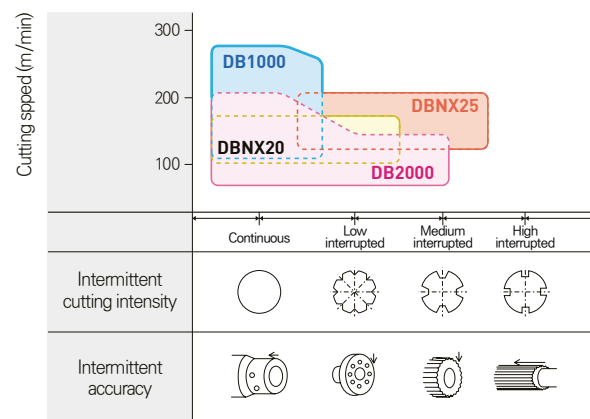

Recommended Machining Works

Outer diameter boring

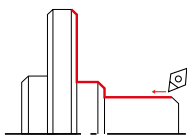

Inner diameter (curved surface) boring

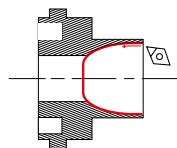

Width decision groove machining

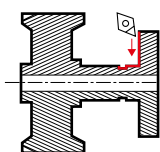

Cross-sectional machining

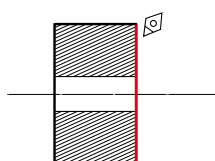

Dice steel

Non-coated cBN

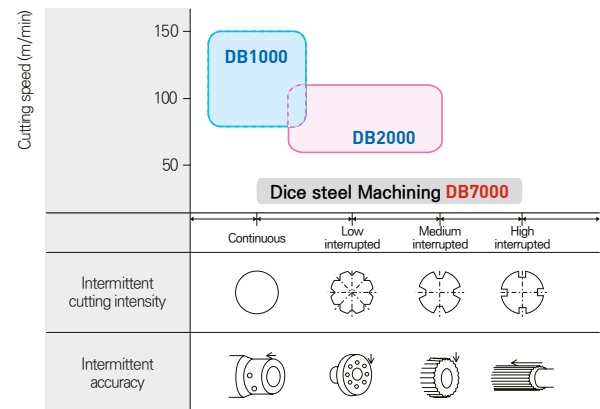



Machining example

DNC250 TEST RESULT

Grade	DNC250	Third-party cBN
INSERTS	2NU-DNGA150408	
Parts name (workpiece)	H6 Swash plate (FCD55 Plate)	
Vc(m/min)		
f(mm/rev)	0.06	
ap(mm)	0.05 - 0.10	
Dry/wet cutting	Wet cutting	

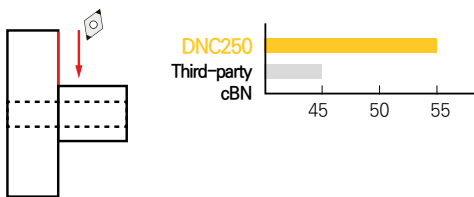

DNC250 TEST RESULT

Grade	DNC250	Third-party cBN
INSERTS	3NU-TNGA160408	
Parts name (workpiece)	Shaft UD Brake(SCR420HB)	
Vc(m/min)	160	
f(mm/rev)	0.08	
ap(mm)	0.425	
Dry/wet cutting	Wet cutting	

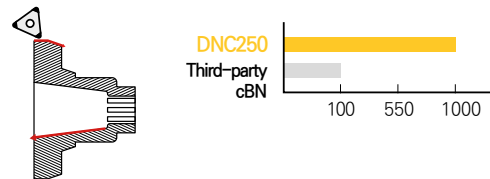

DNC250 TEST RESULT

Grade	DNC250	Third-party cBN
INSERTS	2NU-VCGW160408	
Parts name (workpiece)	Trans driver gear (SCM422)	
Vc(m/min)	90	
f(mm/rev)	0.15	
ap(mm)	0.15	
Dry/wet cutting	Wet cutting	

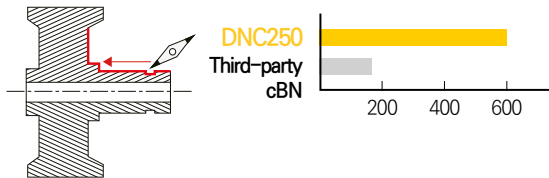

DNC250 TEST RESULT

Grade	DNC250	Third-party cBN
INSERTS	2NU-VNGA160408	
Parts name (workpiece)	CLUTCH BODY(SCR420 8903)	
Vc(m/min)	140	
f(mm/rev)	0.12	
ap(mm)	0.025/0.075	
Dry/wet cutting	Wet cutting	

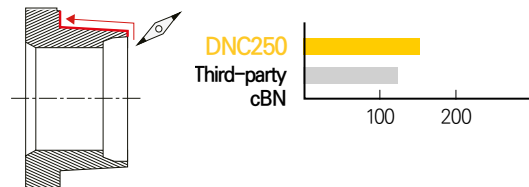

DNC350 TEST RESULT

Grade	DNC350	Third-party cBN
INSERTS	2NU-CNGA120408	
Parts name (workpiece)	Anulus Gear(SCR420)	
Vc(m/min)	200	
f(mm/rev)	0.05 - 0.08	
ap(mm)	0.4	
Dry/wet cutting	Wet cutting	

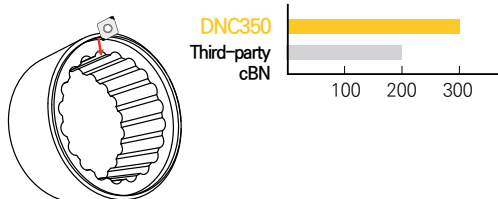

DNC350 TEST RESULT

Grade	DNC350	Third-party cBN
INSERTS	2NU-CNGA120404	
Parts name (workpiece)	Retainer(SAPH440-P)	
Vc(m/min)	150	
f(mm/rev)	0.2	
ap(mm)	0.10-0.20	
Dry/wet cutting	Wet cutting	

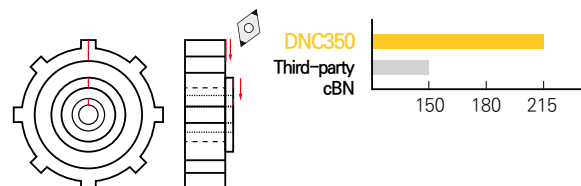

※ The details may vary according to machining environments.



cBN Heat-treat steel



Example of uncoated grades machining

Machining example

DB1000 TEST RESULT

Grade	DB1000	Third-party cBN
INSERTS	NU-TPGW110304	
Parts name (workpiece)	Inner diameter boring machining (SUJ2)	
Vc(m/min)	120	
f(mm/rev)	0.06	
ap(mm)	0.2	
Dry/wet cutting	Wet cutting	

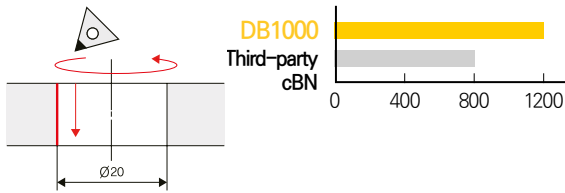

DB1000 TEST RESULT

Grade	DB1000	Third-party cBN
INSERTS	2NU-CNGA120408	
Parts name (workpiece)		
Vc(m/min)	282	
f(mm/rev)	0.1	
ap(mm)	0.1	
Dry/wet cutting	Wet cutting	

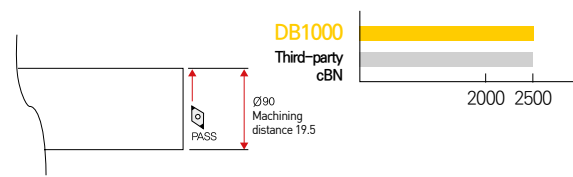

DB1000 TEST RESULT

Grade	DB1000	Third-party cBN
INSERTS	2NU-CNGA120412-W	
Parts name (workpiece)	Reactor	
Vc(m/min)	210	
f(mm/rev)	0.15	
ap(mm)	0.23	
Dry/wet cutting	Wet cutting	

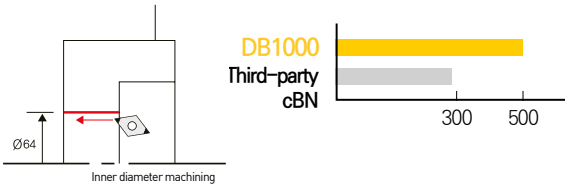

DB2000 TEST RESULT

Grade	DB2000	Third-party cBN
INSERTS	2NU-DNGA150408	
Parts name (workpiece)	Poly slide (SCM415H CVT)	
Vc(m/min)	150	
f(mm/rev)	0.1	
ap(mm)	0.2	
Dry/wet cutting	Wet cutting	

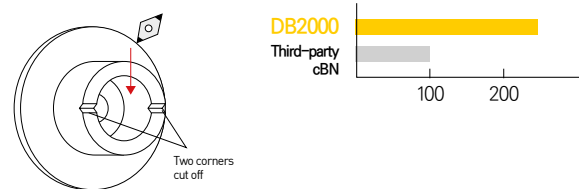

DB2000 TEST RESULT

Grade	DB2000	Third-party cBN
INSERTS	2NU-DNGA150408	
Parts name (workpiece)	Plunger (SKD11)	
Vc(m/min)	100	
f(mm/rev)	0.03 - 0.25	
ap(mm)	0.04	
Dry/wet cutting	Wet cutting	

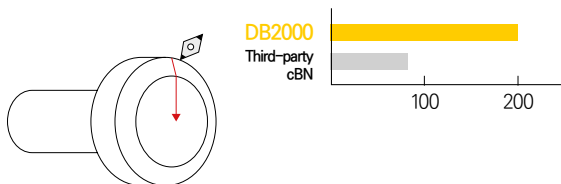

DB2000 TEST RESULT

Grade	DB2000	Third-party cBN
INSERTS	NU-TPGW110308	
Parts name (workpiece)	Clutch parts (SCM415H)	
Vc(m/min)	135	
f(mm/rev)	0.08	
ap(mm)	0.15	
Dry/wet cutting	Wet cutting	

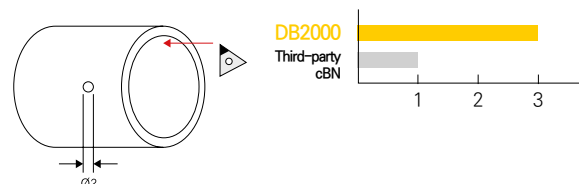

※ The details may vary according to machining environments.

Chuck

Arbor/Modular

Boring tool

Angular head

cBN/PCD

TAUMAX

Other



Machining example

DBNX20 TEST RESULT

Grade	DBNX20	Third-party cBN
INSERTS	VBMW160412	
Parts name (workpiece)	BH-RR Outer wheel	
Vc(m/min)	130	
f(mm/rev)	0.1	
ap(mm)	0.2	
Dry/wet cutting	Wet cutting	

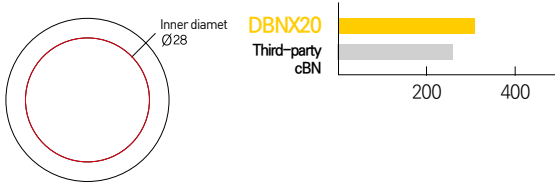

DBNX20 TEST RESULT

Grade	DBNX20	Third-party cBN
INSERTS	2NU-CNGA120408	
Parts name (workpiece)	Reactor	
Vc(m/min)	221~248	
f(mm/rev)	0.1	
ap(mm)	0.2	
Dry/wet cutting	Wet cutting	

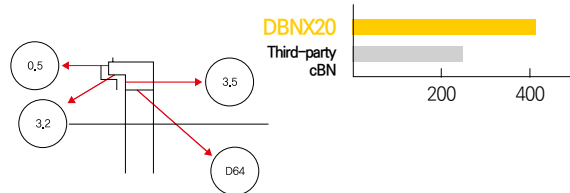

DBNX20 TEST RESULT

Grade	DBNX20	Third-party cBN
INSERTS	2NU-DNGA150612	
Parts name (workpiece)	Transmission(STB2)	
Vc(m/min)	137	
f(mm/rev)	0.18-0.20	
ap(mm)	0.08-0.10	
Dry/wet cutting	Wet cutting	

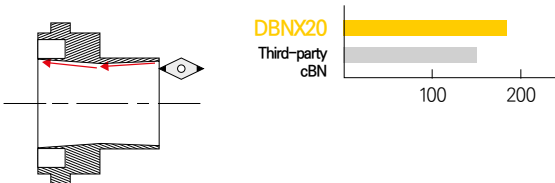

DBNX20 TEST RESULT

Grade	DBNX20	Third-party cBN
INSERTS	NU-TNMA160408	
Parts name (workpiece)	Flange(HrC62 SCM415)	
Vc(m/min)	150	
f(mm/rev)	0.1	
ap(mm)	0.12	
Dry/wet cutting	Wet cutting	

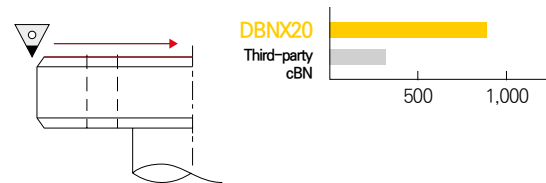

DBNX20 TEST RESULT

Grade	DBNX20	Third-party cBN
INSERTS	CNMA120408	
Parts name (workpiece)	Chain Sprocket(sintered alloy)	
Vc(m/min)	200	
f(mm/rev)	0.1	
ap(mm)	0.1	
Dry/wet cutting		



DBNX20 TEST RESULT

Grade	DBNX20	Third-party cBN
INSERTS	2NU-DNGA150412	
Parts name (workpiece)	Beerling outer wheel(S55 CR)	
Vc(m/min)	190	
f(mm/rev)	0.15	
ap(mm)	0.2	
Dry/wet cutting		



※ The details may vary according to machining environments.



cBN Heat-treat steel



Example of uncoated grades machining

Machining example

DBNX25 TEST RESULT

Grade	DBNX25	Third-party cBN
INSERTS	2NU-CNGA120412-W	
Parts name (workpiece)	Reactor	
Vc(m/min)	200~220	
f(mm/rev)	0.12~0.16	
ap(mm)	0.12~0.16	
Dry/wet cutting	Wet cutting	

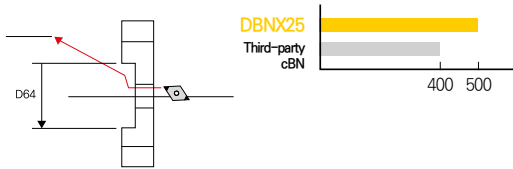

DBNX25 TEST RESULT

Grade	DBNX25	Third-party cBN
INSERTS	NU-TNMA160408	
Parts name (workpiece)	Gear (HrC60 SCM420)	
Vc(m/min)	150	
f(mm/rev)	0.12	
ap(mm)	0.2	
Dry/wet cutting	Wet cutting	

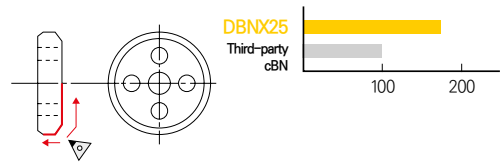

DBN250 TEST RESULT

Grade	DBN250	Third-party cBN
INSERTS	3NU-TPGB110308	
Parts name (workpiece)	Sprocket Crank Shaft(SCM415)	
Vc(m/min)	120-180	
f(mm/rev)	0.18	
ap(mm)	0.12	
Dry/wet cutting	Wet cutting	

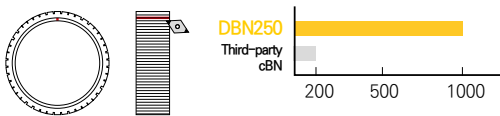

DBN350 TEST RESULT

Grade	DBN350	Third-party cBN
INSERTS	NU-CNMA120412	
Parts name (workpiece)	Gear shaft (SCR420H)	
Vc(m/min)	125	
f(mm/rev)	0.15	
ap(mm)	0.3	
Dry/wet cutting	Wet cutting	

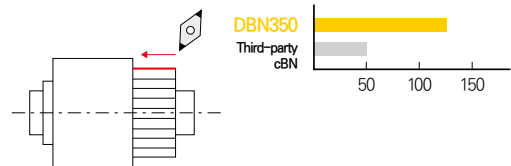

※ The details may vary according to machining environments.

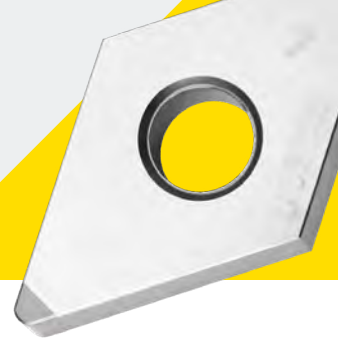

Features and cutting conditions of cBN grade

Applications	Workpiece	Grade	Cutting conditions				Feed f(mm/rev)	Cutting depth ap(mm)		
			Cutting speed Vc(m/min)							
			100	500	1000	1500	2000			
Turning	Gray cast iron	DBNS800	200	[Bar chart: 200 to 2000]			2000	0.1 ~ 1.0	≤4.0	
		DBN500	200	[Bar chart: 200 to 700]			700	0.1 ~ 0.5	≤1.0	
		DB7000	500	[Bar chart: 500 to 2000]			2000	0.1 ~ 0.5	≤1.0	
	Alloy cast iron	DBNS800	200	[Bar chart: 200 to 1000]			1000	0.1 ~ 0.8	≤2.0	
		Ductile cast iron	DBN500	100	[Bar chart: 100 to 350]			350	0.1 ~ 0.4	≤0.5
			DB1000	250	[Bar chart: 250 to 500]			500	0.1 ~ 0.2	≤0.2
Milling	Gray cast iron	DBN700	800	[Bar chart: 800 to 2000]			2000	0.1 ~ 0.5	≤0.5	
		DBNS800	800	[Bar chart: 800 to 2000]			2000	0.1 ~ 1.0	≤4.0	
		DB7000	80	[Bar chart: 80 to 200]			200	0.1 ~ 0.4	≤0.5	

Applicable area

Gray cast iron

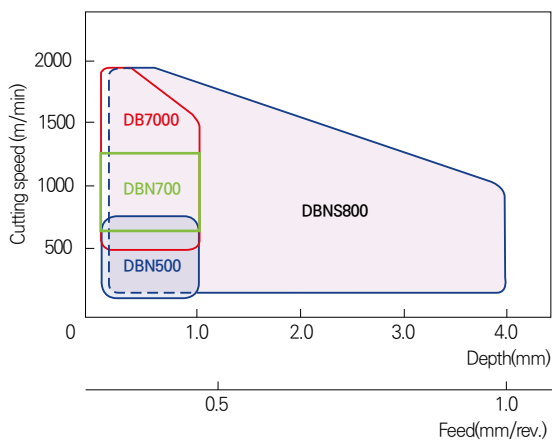

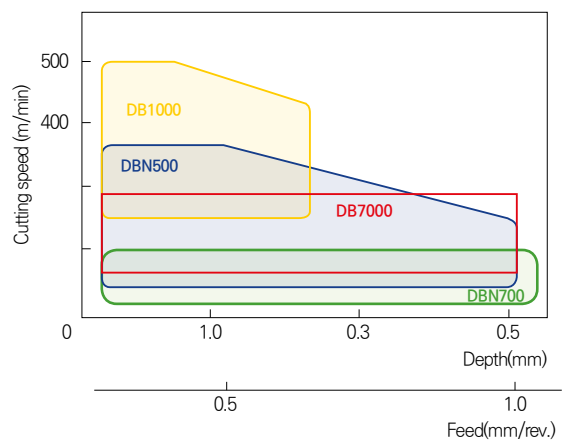

Ductile cast iron

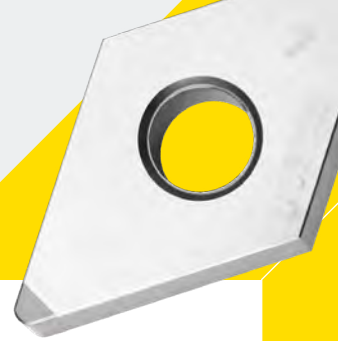



cBN grade features

Classification	Grade		Insert color	Applications	Features
	Coated or Name uncoated	Name			
	Uncoated	DBN700		High-speed cutting of FC / cutting of milling of FC, cutting of iron metal heat-treated parts cutting of high-hardness roll / cutting of heat-resistant alloy	Grades whose material strength and thermal conductivity are improved by greatly increasing cBN content and optimizing sintered tissues
		DBN500		FC, FCD cutting, high-hardness VSR cutting, high-hardness roll grinding cutting	For cast iron cutting, cBN sintered body formation is optimized and wear resistance and damage resistance are excellent
		DB7000		Foundry machining	For cast-iron difficult-to-cut materials machining, wear resistance and damage resistance are excellent
		DBNS800		Large cutting depth machining, high-precision grinding machining	The solid structure capable to be used cutting knife of entire insert, which responds brazing type machining and high-speed grinding unlike conventional brazing type

Machining example

DBN500 TEST RESULT

Grade	DBN500	Third-party cBN
INSERTS	SPGN090308	
Parts name (workpiece)	Crank bore(FC250 = FCD450 Inner boring)	
Vc(m/min)	150	
f(mm/rev)	0.15	
ap(mm)	0.5	
Dry/wet cutting	Wet cutting	



DBN500 TEST RESULT

Grade	DBN500	Third-party cBN
INSERTS	CNMA120412	
Parts name (workpiece)	Compressor Comp(FC250 facing, Interrupted)	
Vc(m/min)	400	
f(mm/rev)	0.07	
ap(mm)	0.15	
Dry/wet cutting	Wet cutting	

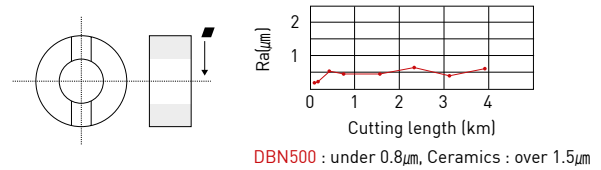

DBN700 TEST RESULT

Grade	DBN700	Third-party cBN
INSERTS	Special Bite	
Parts name (workpiece)	VSR intake(Hv250-330 Plunge Cutting)	
Vc(m/min)	95	
f(mm/rev)	0.08	
ap(mm)	0.2	
Dry/wet cutting	Dry cutting	

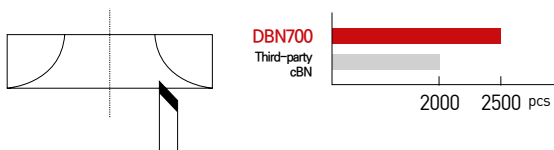

DBN700 TEST RESULT

Grade	DBN700	Third-party cBN
INSERTS	SPGN090308 / TNGA150408	
Parts name (workpiece)	Fly wheel(FC300 facing)	
Vc(m/min)	600	
f(mm/rev)	0.15	
ap(mm)	0.2	
Dry/wet cutting	Wet cutting	



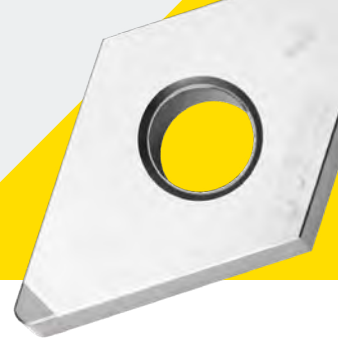

Features and cutting conditions of cBN grade

* First recommended

Classification	Grade		Insert color	Applications	Features
	Coated or Name uncoated	Name			
Sinter Alloy	Uncoated	DB7000		High density heat treated parts	Features excellent wear resistance and damage resistance in sintered alloy machining to stably implement a long service life
		DB7500*		High density heat treated parts	Suitable for sintered alloy grinding machining by maintaining the best cutting taste

Workpiece	Grade	Cutting conditions				Feed f(mm/rev)	Cutting depth ap(mm)	
		Cutting speed Vc(m/min)						
		100	150	200	250	300		
General sintered alloy	DB7000	80	[Bar chart showing Vc range from 80 to 300]			300	0.1 ~ 0.3	≤0.25
	DB7500*	80	[Bar chart showing Vc range from 80 to 300]			300	0.1 ~ 0.15	≤0.25

Workpiece	Grade	Cutting conditions				Feed f(mm/rev)	Cutting depth ap(mm)	
		Cutting speed Vc(m/min)						
		100	150	200	250	300		
High-density heat-treated sintered alloy	DB7000	80	[Bar chart showing Vc range from 80 to 200]			200	0.1 ~ 0.3	≤0.2
	DB7500*	80	[Bar chart showing Vc range from 80 to 200]			200	0.1 ~ 0.15	≤0.2

Applicable area

General sintered alloy

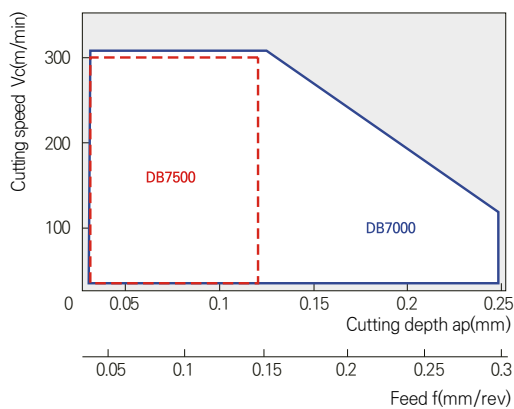

High-density heat-treated sintered alloy

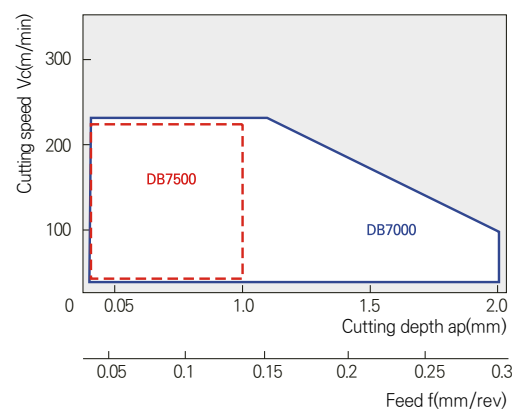

※ The details may vary according to machining environments.



cBN Sinter Alloy

Sinter Alloy

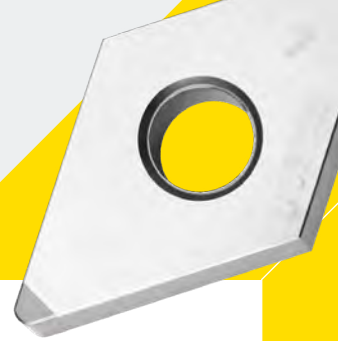

cBN cutting performance

Comparison of cutting performance by tool materials

Workpiece	Equivalent to SMF4040
Details of machining	High interrupted cross-sectional machining with a groove, hole $\varnothing 80$ - $\varnothing 100$ [after 40 pass machining]
Tool model no.	TNGA160404 / DB7000
Cutting conditions	f=0.1mm/rev, ap=0.1mm, wet cutting

General sintered alloy up to $V_c=100\text{m/min}$ can be machined even in the case of cemented carbide alloy or cermet. But after about $V_c=120\text{m/min}$ it is rapidly worn so surface roughness is weakened and burr is expanded. On the contrary, cBN ensures reliable machining as it is excellent in surface roughness in high-speed areas, wear resistance, and burr inhibition.

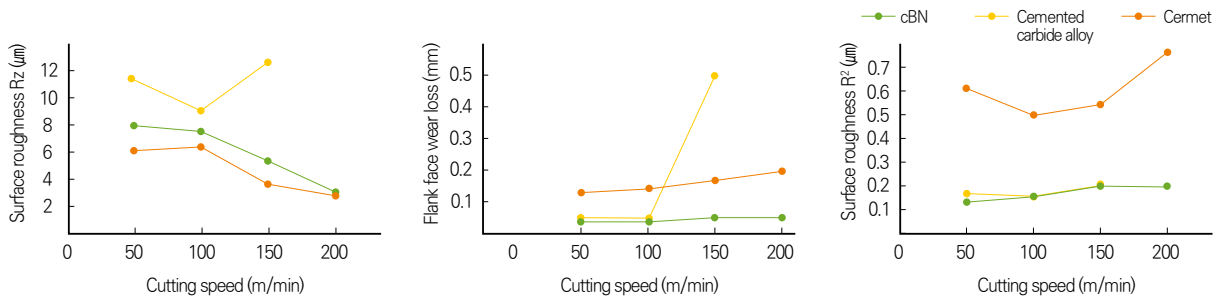

Valve seat ring (VSR)

VSR is divided into VSR for Intake (IN) and VSR for Exhaust (EX). Generally, VSR for EX is of high hardness.

Recommended grade

	Gasoline engine VSR material	Diesel engine VSR material
Flange cutting	DB7000 DBN350	DB7000 DBN350
Traverse cutting	DB7000 DBN500	DB7000 DBN500
Workpiece hardness (HV)	Low ◀ HV300 ▶ High	Low ◀ HV300 ▶ High

Recommendation conditions

Cutting speed V_c (m/min)	Feed f (mm/rev)	Cutting depth a_p (mm)
50~100	0.03~0.2	0.05~0.5

Cutting example

The tool service life was increased more than two fold versus conventional one when machining with DB7000 whose damage resistance is excellent.

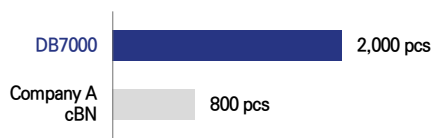

※ Cylinder head shape

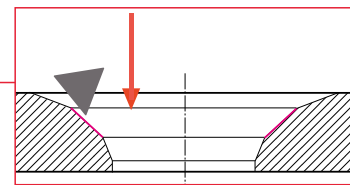

Recommendation conditions

Workpiece	Sintered alloy (150-250HV)
Details of machining	VSR(IN) 45-face grinding machining
Tool model no.	TBGN060104(DB7000)
Cutting conditions	$V_c=100\text{m/min}$, $f=0.08\text{mm/rev}$, wet cutting

※ The details may vary according to machining environments.

1:1 CHAT



DNC100

Coated cBN

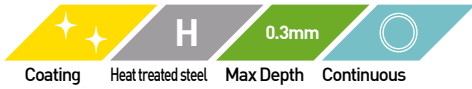

Features

- Grade first recommended of high-speed continuous machining
- High heat resistance with high oxidation temperature
- Thin film applied with high hardness and high resistance to oxidation and chipping

Grade	Texture	Binder	cBN content (%)	Grain size (μm)	Hardness HV (Gpa)
DNC100		TiN	50 - 55	2	31 - 34

Performance comparison test

Wear resistance comparison test in high-speed machining

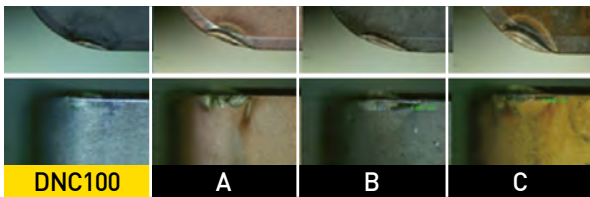

Cutting conditions

Insert model no.	2NU-CNGA120408
Test holder	DCLNL2525-M12
Workpiece	SCM415 (58~62HrC)
Machining speed	300m/min
Feed	0.1mm/rev
Depth of cutting	0.1mm
Dry/wet cutting	Dry cutting

Applicable area

Cutting speed (m/min)	DNC100			
	Continuous	Low interrupted	Medium interrupted	Heavy interrupted
300				
180				
Intermittent cutting intensity				
Intermittent accuracy				

Wear loss

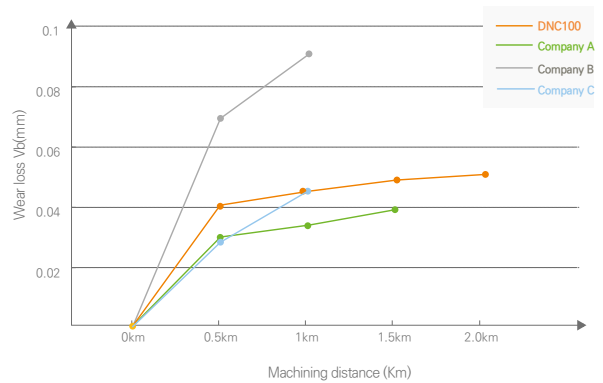

Recommended Cutting Conditions

- Improved wear resistance and oxidation resistance with high-hardness thin film adopted
- Significantly improved resistance to chipping, fracture, and wear

Cutting Speed VC (m/min)	180	300
Feed f (mm/rev)	0.03	0.3
Single cutting depth D.O.C ap (mm)	0.03	0.3

※ The details may vary according to machining environments.



DNC250

Coated cBN

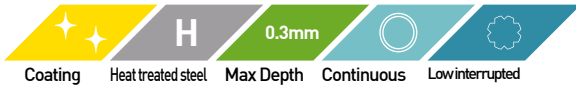
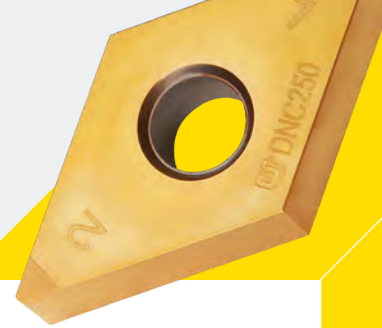

Features

- Grade first recommended for continuous machining
- General-purpose cBN that enables machining ranging from Continuous cutting to Low interrupted cutting by PVD coating application
- Wear resistance improved

Grade	Texture	Binder	cBN content (%)	Grain size (μm)	Hardness HV (Gpa)
DNC250		TiC	65 - 70	4	32 - 34



Machining example

Grade	DNC250	Third-party cBN
INSERTS	3NU-TNGA160408	
Parts name (workpiece)	Shaft UD Brake(SCR420HB)	
Vc(m/min)	160	
f(mm/rev)	0.08	
ap(mm)	0.425	
Dry/wet cutting	Wet cutting	

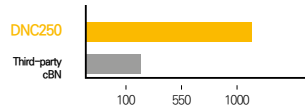
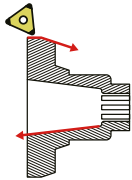

Grade	DNC250	Third-party cBN
INSERTS	2NU-CNGA120408	
Parts name (workpiece)	Hardness : Hrc40~50(SCM92 0HVS II)	
Vc(m/min)	280	
f(mm/rev)	0.08-0.15	
ap(mm)	0.2	
Dry/wet cutting	Wet cutting	

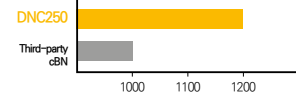
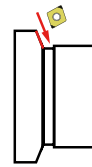

Applicable area

Cutting speed (m/min)	DNC250			
	Continuous	Low interrupted	Medium interrupted	Heavy interrupted
220	DNC250			
120				
Intermittent cutting intensity				
Intermittent accuracy				

Recommended Cutting Conditions

Cutting Speed VC (m/min)	120	220
Feed f(mm/rev)	0.05	0.3
Single cutting depth D.O.C ap (mm)	0.05	0.3

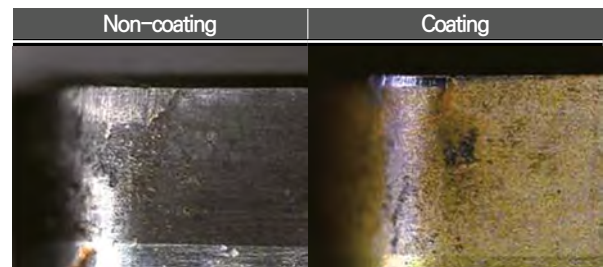

※ The details may vary according to machining environments.

Chuck

Arbor/Modular

Boring tool

Angular head

cBN/PCD

TAUMAX

Other

1:1 CHAT



DNC300

Coated cBN

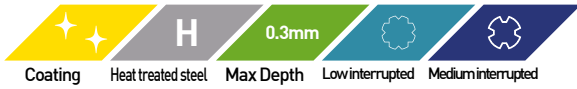

Features

- Grade first recommended for machining ranging from Low interrupted to Medium interrupted
- Improved resistance to chipping and wear versus rival products
- Minimized coating peeling due to its stable coating

Grade	Texture	Binder	cBN content (%)	Grain size (μm)	Hardness HV (Gpa)
DNC300		TiN	65 - 70	4	29 - 31



Performance comparison

[Interrupted] V90 F0.1 D0.1 / SCR420H(HrC58-62) / DRy (4PATH =0.21KM)

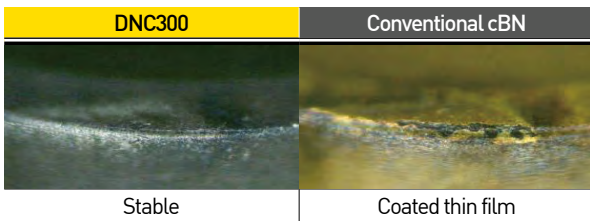
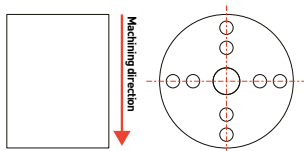

[Outer dia. interrupted] V120 F0.1 D0.1 / 9PATH

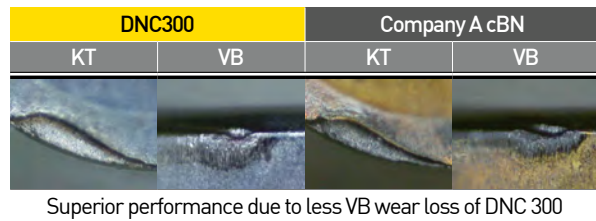
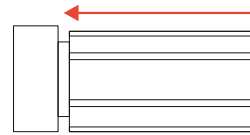

Machining example

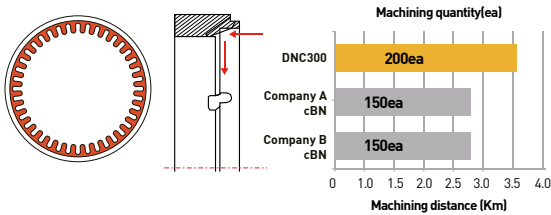

Grade	DNC300	Company A cBN	Company B cBN
INSERTS	CNGA120408		
Parts name (workpiece)	Heat-treated steel (HrC57.8)		
Vc(m/min)	160		
f(mm/rev)	0.08		
ap(mm)	0.2-0.3		
Dry/wet cutting	Wet cutting		

Applicable area

Cutting speed (m/min)	DNC300			
	Continuous	Low interrupted	Medium interrupted	Heavy interrupted
200				
90				
Intermittent cutting intensity				
Intermittent accuracy				

Recommended Cutting Conditions

- Wear resistance and oxidation resistance are improved with high-hardness thin film adopted
- Significantly improved resistance to chipping, fracture, and wear

Cutting Speed VC (m/min)	90	200
Feed f(mm/rev)	0.05	0.3
Single cutting depth D.O.C ap (mm)	0.05	0.25

※ The details may vary according to machining environments.



DNC350

Coated cBN

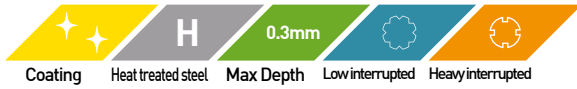

Features

- Grade first recommended for interrupted cutting
- Maintains functionality and precision for a long time due to its advanced coating technology
- Economical due to its longer service life

Grade	Texture	Binder	cBN content (%)	Grain size (μm)	Hardness HV (Gpa)
DNC350		TiN	60 - 65	1	33 - 35

Machining example

Grade	DNC350	Third-party cBN
INSERTS	2NU-CNGA120408	
Parts name (workpiece)	SCM415(HrC58-60)	
Vc(m/min)	120	
f(mm/rev)	0.1	
ap(mm)	0.1	
Dry/wet cutting	Dry cutting	

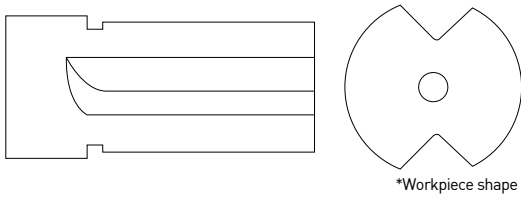

Applicable area

Cutting speed (m/min)	DNC350			
	Continuous	Low interrupted	Medium interrupted	Heavy interrupted
Intermittent cutting intensity				
Intermittent accuracy				

Wear loss

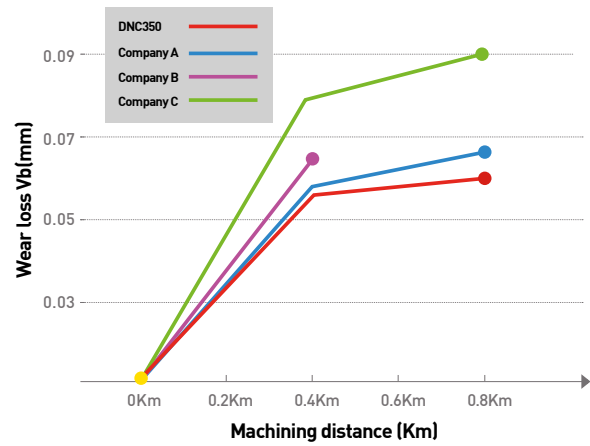

Recommended Cutting Conditions

Cutting Speed VC (m/min)	90	150
Feed f(mm/rev)	0.05	0.3
Single cutting depth D.O.C ap (mm)	0.05	0.25

※ The details may vary according to machining environments.

1:1 CHAT



DB1000

Uncoated cBN

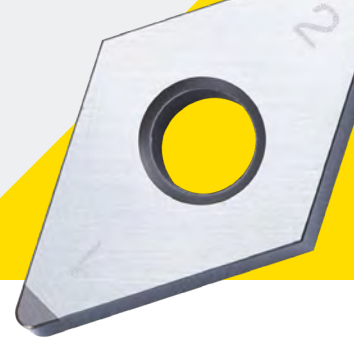

Non	H	0.3mm	
Non-Coating	Heat treated steel	Max Depth	Continuous

Features

- Grade for high-speed machining with the best wear resistance among non-coated cBNs
- Features an excellent tool service life in the continuous cutting ~ Low interrupted cutting
- Focuses on wear resistance and improves fracture resistance
- Improves heat resistance and strength by high-purity TiCN ceramic bonding materials

Grade	Texture	Binder	cBN content (%)	Grain size (μm)	Hardness HV (Gpa)
DB1000		TiCN	40 - 45	1	27 - 31



Newly developed high-purity ceramic bonding material

Conventional grade

Impurities included in conventional grade ceramic bonding materials decreased the strength and heat resistance of sintered parts, becoming the cause of crack (fracture) and wear.

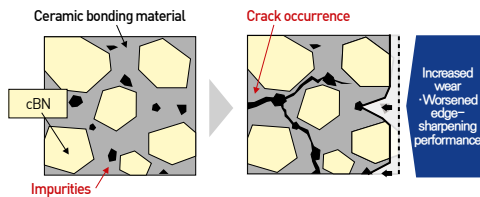

DB1000

DB1000 enhanced heat resistance and strong tenacity by reducing impurities to the very limit using the newly developed "high-purity ceramic bonding material"!

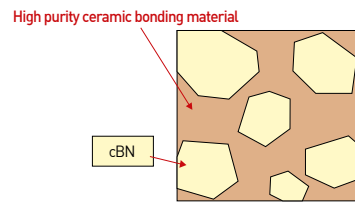

Cutting performance

Dimension accuracy comparison (continuous cutting)

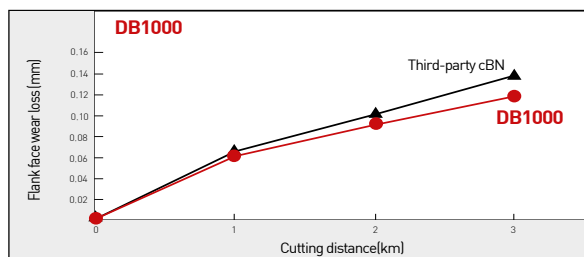

Workpiece : SUJ2 Round bar [58-62HRC]
Cutting conditions : Vc=150m/min, f=0.1mm/rev, ap=0.2mm, Dry cutting

Machining precision

Wear resistance (continuous cutting)

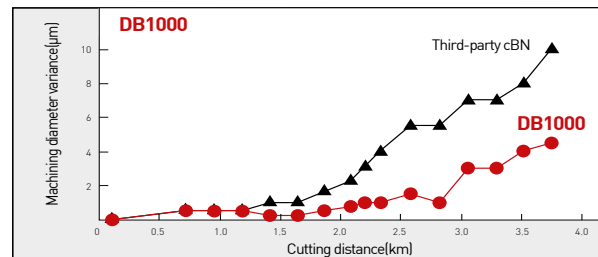

Workpiece : SCM415H ø130 Outer diameter [58-62HRC]
Tool model no. : 2NU-CNGA120408
Cutting conditions : Vc=200m/min, f=0.1mm/rev, ap=0.1mm, Wet cutting

Applicable area

Cutting speed (m/min)	Grade Selection			
	DB1000	DBN20	DBN25	DBN350
300	Yes	Yes	Yes	Yes
200	Yes	Yes	Yes	Yes
100	Yes	Yes	Yes	Yes
DB2000	Yes	Yes	Yes	Yes
Intermittent cutting intensity	Continuous	Low interrupted	Medium interrupted	Heavy interrupted
Intermittent accuracy				

Recommended Cutting Conditions

Cutting Speed Vc (m/min)	130	250
Feed f (mm/rev)	0.03	0.15
Single cutting depth D.O.C ap (mm)	0.03	0.2

※ Cutting oil : Continuous cutting dry/wet, Interrupted cutting dry

※ The details may vary according to machining environments.



DB2000

Uncoated cBN



Non	H	0.3mm		
Non-Coating	Heat treated steel	Max Depth	Continuous	Medium interrupted

Features

- General-purpose grade that responds to overall heat-treated steel – Realizes a stable tool service life ranging from continuous cutting to Low / Medium interrupted cutting
- Highly compatible with fracture resistance and wear resistance – Both properties greatly improved by the use of the high-purity ceramic bonding material
- Achieves a stable surface roughness based on edge-sharpening performance

Grade	Texture	Binder	cBN content (%)	Grain size (μm)	Hardness HV (Gpa)
DB2000		TiN	50 - 55	2	31 - 34

Newly developed high-purity ceramic bonding material

Conventional grade

Impurities included in conventional grade ceramic bonding materials decreased the strength and heat resistance of sintered parts, becoming the cause of cracks (fracture) and wear.

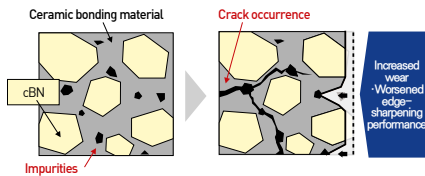

DB2000

DB2000 realizes enhanced heat resistance and strong tenacity by reducing impurities to the very limit using the newly developed 「high-purity ceramic bonding material」!

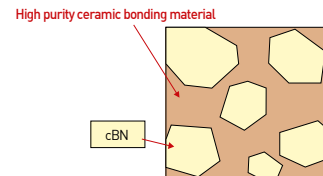

Machining precision

Surface roughness comparison (continuous cutting)

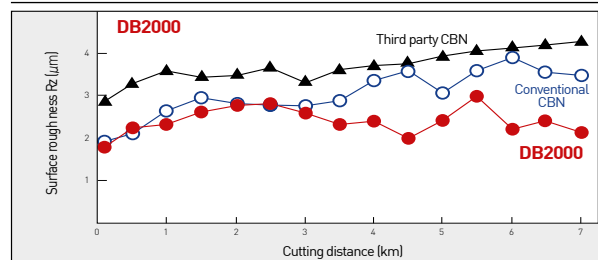

Workpiece : SCM415H Round bar (58-62HRC)
Tool model no. : 2NU-CNGA120408
Cutting conditions : Vc=100m/min, f=0.08mm/rev, ap=0.2mm, Dry cutting

Cutting performance

Wear resistance (continuous cutting)

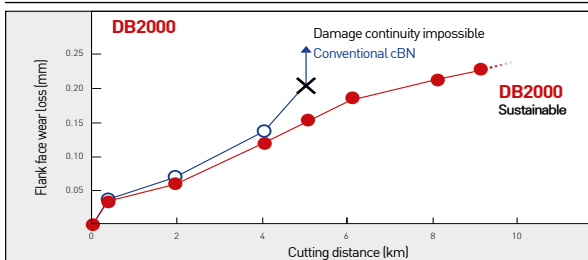

Workpiece : SCM415H Round bar (58-62HRC)
Cutting conditions : Vc=100m/min, f=0.1mm/rev, ap=0.2mm, Dry cutting

Applicable area

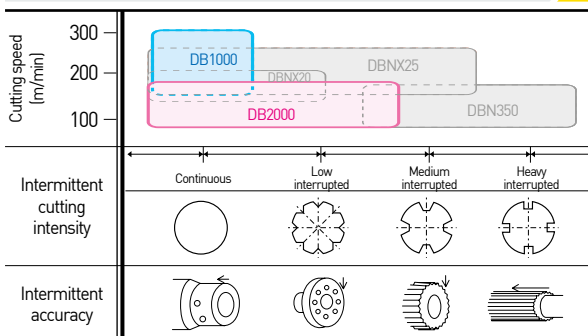

Recommended Cutting Conditions

Cutting Speed VC (m/min)	80	200
Feed f (mm/rev)	0.03	0.2
Single cutting depth D.O.C ap (mm)	0.03	0.3

※ Cutting oil : Continuous cutting dry/wet, Interrupted cutting dry

※ The details may vary according to machining environments.

Chuck

Arbor/Modular

Boring tool

Angular head

cBN/PCD

TAUMAX

Other

1:1 CHAT



DB7000

Uncoated cBN

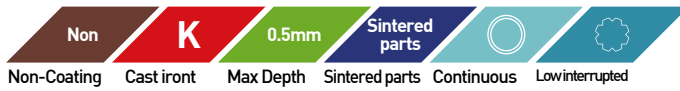

Features

- Ideal for high-speed grinding machining of cast iron
- Suppresses heat crack and realizes excellent damage resistance by highspeed machining of gray cast iron
- Realizes highly efficient sintered alloy machining
- Provides a stably longer service life in case of machining of sintered alloys with diverse shape hardness by meeting the requirements for cutting edge treated products of high standard+2 types
- Responds to various difficult-to-cut materials
- Features high performance for difficult-to-cut materials such as rolls, highspeed tools, and heat resistant alloys, etc.

Grade	Texture	Binder	cBN content (%)	Grain size (μm)	Hardness HV (Gpa)
DB7000		CO Compound	90 - 95	2	41 - 44



Tissue that acidized cBN sintered parts

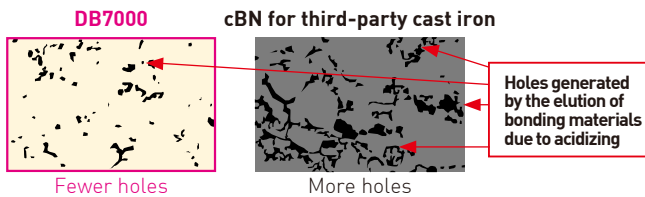

Provides an excellent damage resistance and an enhanced inter-cBN particle coherence by sintering intermediate particle cBNs in high density to realize the best content. Ensures a long service life and stable machining in highspeed grinding of hard-to-cut materials of cast iron sintered alloys.

Cutting performance

Cast iron milling machining

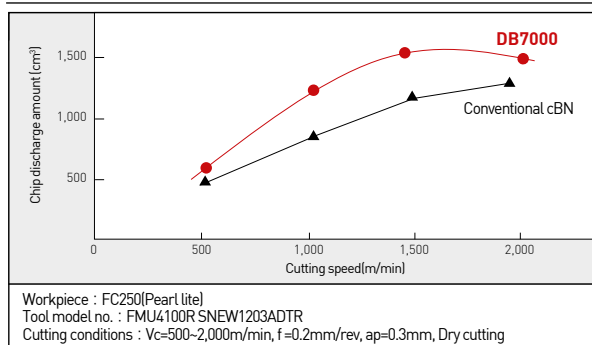

Cast iron turning machining

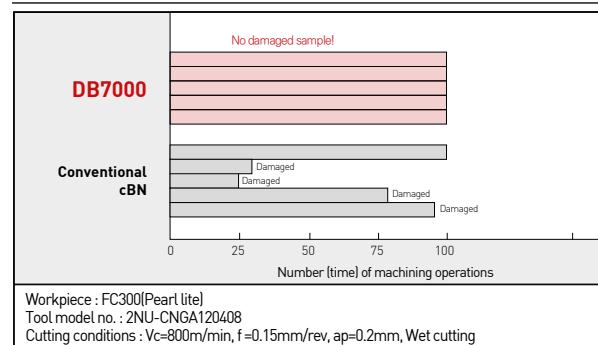

Cast iron turning machining

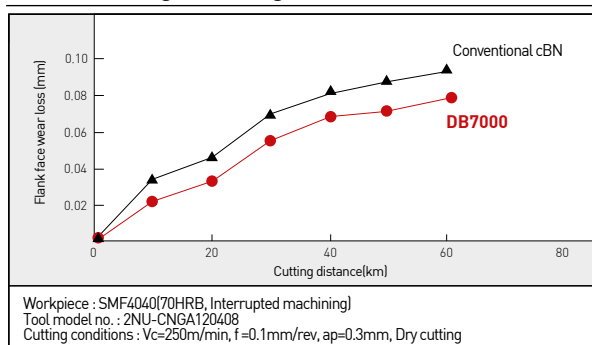

Recommended cutting edge treatment

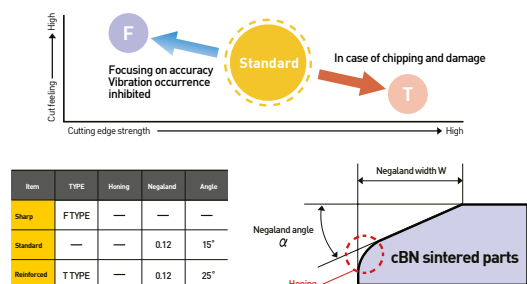

※ The details may vary according to machining environments.



DB7500

Uncoated cBN

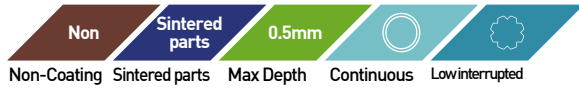

Features

- Ideal for grinding machining of sintered alloys
- Realizes excellent surface roughness and machined surface quality
- Various shapes of sintered parts can cutting by various cutting edge treatment
- Provides burr inhibition and machining precision improvement by F type that focuses on cutting taste designed for sintered alloy machining to meet grade requirements; Features stable resistance to chipping by cutting edge reinforced T type even in case of interrupted grinding machining

Grade	Texture	Binder	cBN content (%)	Grain size (μm)	Hardness HV (Gpa)
DB7500		CO Compound	90 - 95	1	41 - 44

Cutting performance

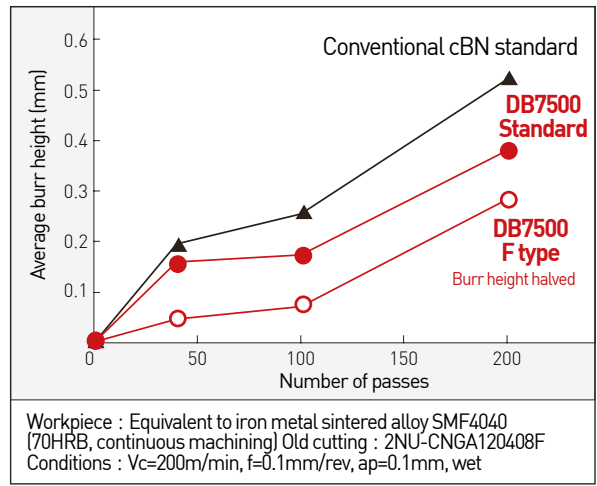
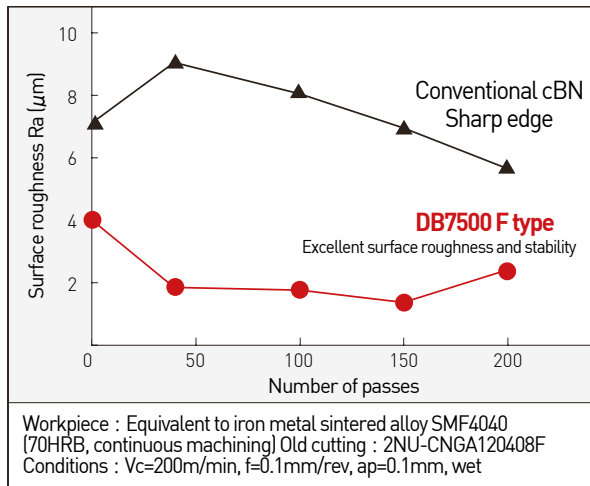

Feed-burr relationship

Workpiece : WT cross section
Tool model no. : 3NU-TNGA160404
Cutting conditions : Vc=200m/min, f=0.1mm/rev, ap=0.1mm, wet cutting

	F type	Standard type	T type
A			
B			

* If Feed is more than 0.1mm/rev, the T type is superior to the standard type in terms of cutting taste and burr can be inhibited.

Recommended cutting edge treatment

Item	TYPE	Honing	Negaland	Angle
Sharp	F TYPE	—	—	—
Standard	—	—	0.12	15°
Reinforced	T TYPE	—	0.12	25°

※ The details may vary according to machining environments.

1:1 CHAT



RA,GA Chip breaker

cBN Chip breaker

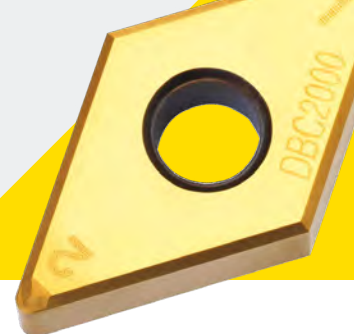

Coating Chip Breaker Max Depth

Features

- Prevents drag of chip into the workpiece during machining
- Ideal for unmanned automatic operations of the cutting process
- The RA chip breaker is for rough boring process
- GA chip breaker is for finishing boring process



Example of use

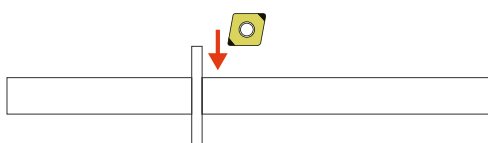

Non-breaker

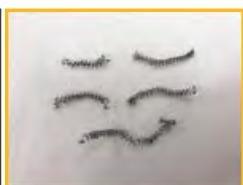

GA Chip breaker

Applicable area

Grade	DNC350(GA)	Third-party cBN
INSERTS	2NU-CNGM120412-GA	
Parts name (workpiece)	Input Shaft(SCM920 HVSI)	
Vc(m/min)	145	
f(mm/rev)	0.1	
ap(mm)	0.4 ~ 0.5	
Dry/wet cutting	Wet cutting (excellent chip breaking versus rival products)	

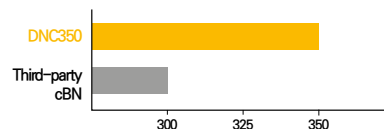

Chip Breaker

GA type

Chip breaker suitable for fine boring

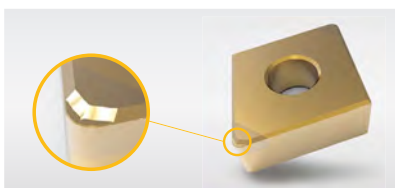

RA type

Chip breaker suitable for rough boring

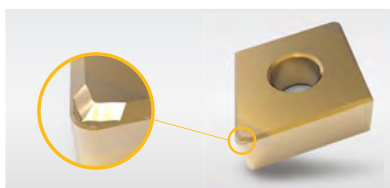

Chip Breaker Features

Superior design fit for chip breaking to induce easy curling

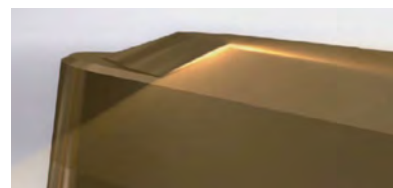

Chip breaker comparison

GA Chip Breaker

V=150m/min
f=0.15 mm/rev
ap=0.15mm

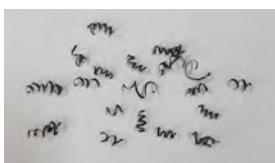

RA Chip Breaker

V=150m/min
f=0.15 mm/rev
ap=0.3mm

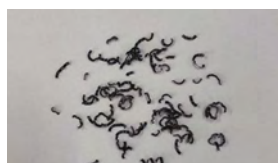

Applicable area

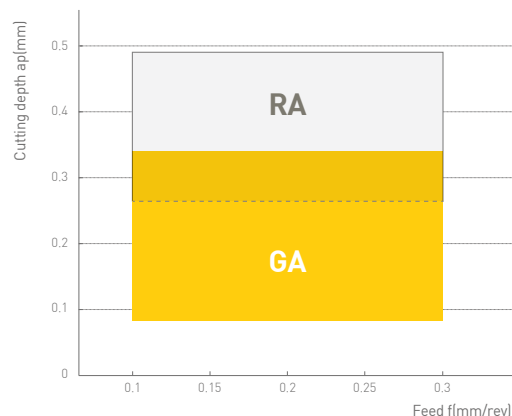

※ The details may vary according to machining environments.



cBN Technical data

Manufacturing process of cBN

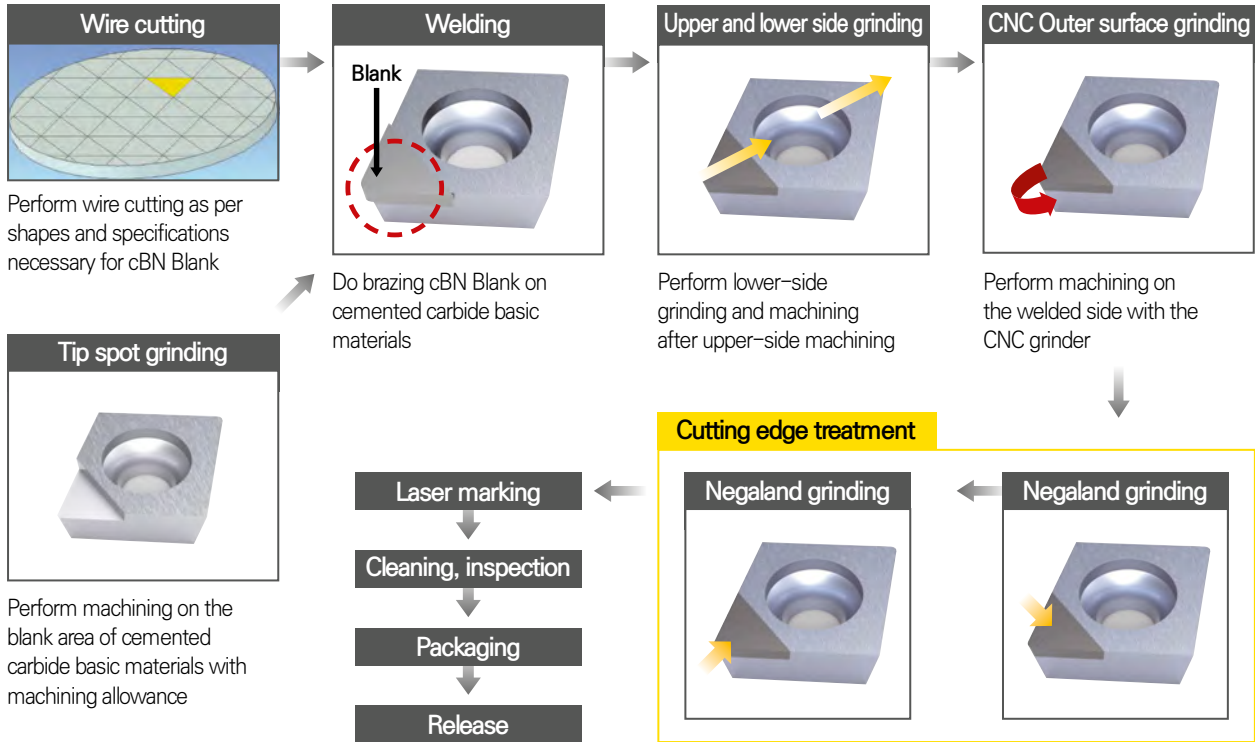

Cutting speed change and tool materials development in history

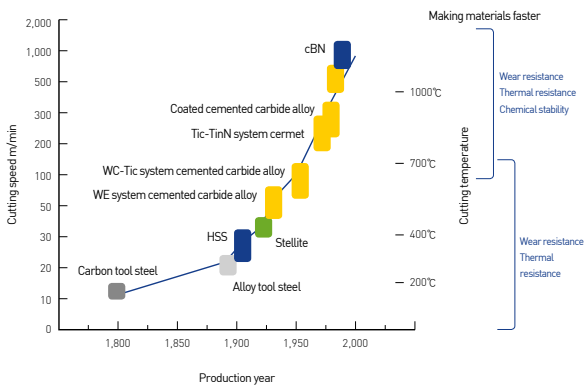

Hardness and intensity of tool materials

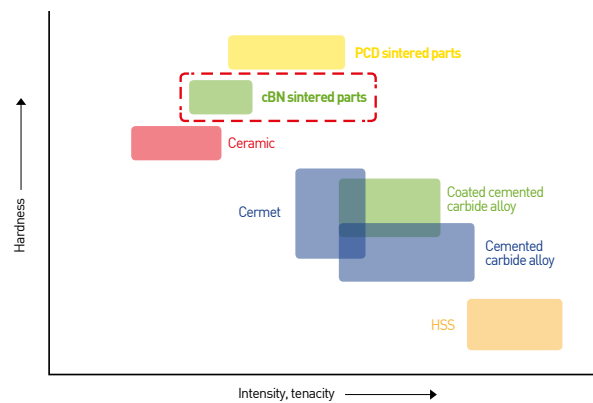



cBN Technical data

Main characteristics of cBN

Main characteristics I of cBN

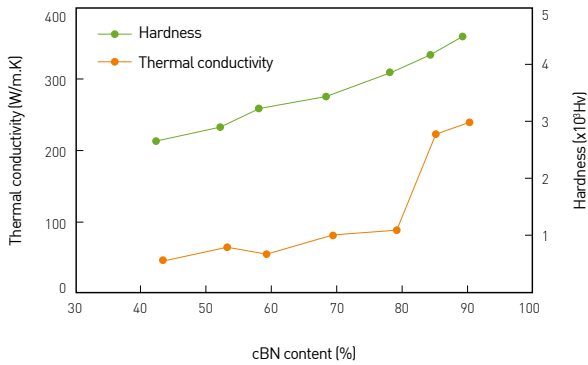

Main characteristics II of cBN

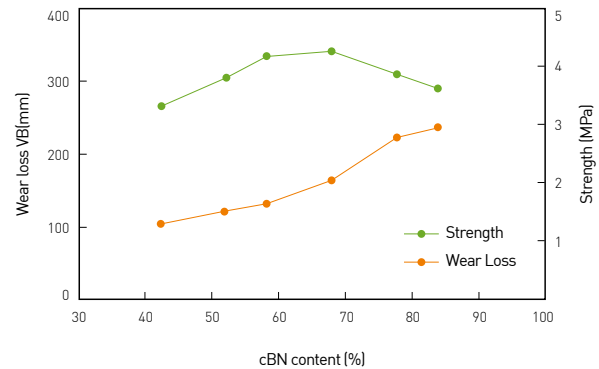







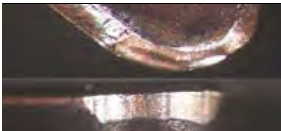

cBN machining workpieces and advantages of cutting machining

Workpiece	Representative parts	Advantages of cutting machining	Corresponding grade
Heat-treated steel	Transmission gear Driving shaft Shafts Valves Hydraulic parts, etc.	<ul style="list-style-type: none"> Improved workpiece phenomenon accuracy Responding to machining of composite parts and micro parts Machining efficiency improved, grinding/polishing minimized Investment equipment cost reduced Environmental measures 	DNC100,DNC250 DNC300,DNC350 DNC400 DB1000, DB2000 DBN250, DBN350 DBNX20, DBNX25
Casting	Engine block Cases Brake disks, etc.	<ul style="list-style-type: none"> Responding to high-speed machining Responding to hard to cut material casting Machining efficiency improved 	DBNS800, DBN500 DB7000
Sintered alloy	WT(VTC) parts Various sprocket rotas oil pump parts valve seats	<ul style="list-style-type: none"> Improved workpiece phenomenon accuracy Responding to heat treatment sintered parts and composite parts Capacity utilization (longer tool service life) High-speed, high-efficiency machining 	DBN500 DB7000, DB7500
Heat resistant alloy	Jet engine parts, etc.	<ul style="list-style-type: none"> Machining efficiency improved Workpiece machining surface roughness improved 	DBNX20



cBN Technical data

Causes of and measures for tool damage

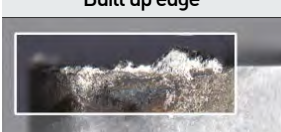
Insert damage type	Causes	Measures
Flank face wear 	<ul style="list-style-type: none"> • Insufficient of wear resistance of tool grade • Too high cutting speed 	<ul style="list-style-type: none"> • Select high wear resistance grade • Decrease cutting speed • Reduce to less than Vc 200m/min. (Measures to increase feed and decrease machining distance are effective.) • Enlarge clearance angle
Crater wear 	<ul style="list-style-type: none"> • Insufficient of crater wear resistance of tool grade • Too high cutting speed 	<ul style="list-style-type: none"> • Change to high-sufficiency machining grade • Decrease cutting speed and increase feed (Low speed, high feed) • Reduce to less than Vc 200m/min. (Measures to increase feed and decrease machining distance are effective.)
Crater damage 		
Flaking damage 	<ul style="list-style-type: none"> • Insufficient tenacity of tool grade • High radial cutting force 	<ul style="list-style-type: none"> • Use high tenacity grade • Increase cutting edge strength (Enlarge Negaland angle and perform honing) • In case of sufficient tenacity of grade, increase cutting taste
Just prior to corner wear 	<ul style="list-style-type: none"> • High stress of boundaries 	<ul style="list-style-type: none"> • Change to grade with strong resistance to corner wear • Increase cutting speed (more than 150m/min) • Change feed to a regular number of machining • Enlarge the Negaland angle and perform honing operation
Previous corner chipping 	<ul style="list-style-type: none"> • Great impact on the front cutting edge and large number of times 	<ul style="list-style-type: none"> • Change to a grade with high resistance to damage • Increase feed (Impact of interruption reduced and chipping inhibited) • Enlarge the Negaland angle and perform honing operation
Horizontal corner chipping 	<ul style="list-style-type: none"> • Great impact on the horizontal cutting edge and large number of times 	<ul style="list-style-type: none"> • Change to a grade with high resistance to damage • Decrease feed • Enlarge horizontal cutting edge angle • Increase R size • Enlarge the Negaland angle and perform honing operation
Crack 	<ul style="list-style-type: none"> • Large heat impact 	<ul style="list-style-type: none"> • In case of wet cutting machining → dry cutting recommended • Change to high thermal conductivity grade • Decrease Vc, f, ap to reduce machining load
Built up edge 	<ul style="list-style-type: none"> • Too low cutting speed • Strong affinity of the workpiece with the tool 	<ul style="list-style-type: none"> • Increase cutting speed • Select a shape whose slope angle is larger than the workpiece • Select a grade whose tenacity is better than the workpiece

Chuck

Arbor/Modular

Boring tool

Angular head

cBN/PCD

TAUMAX

Other



cBN Technical data

Heat-treated steel high-precision machining points

Out of roundness

Perform chucking to apply to the workpiece as equally as possible

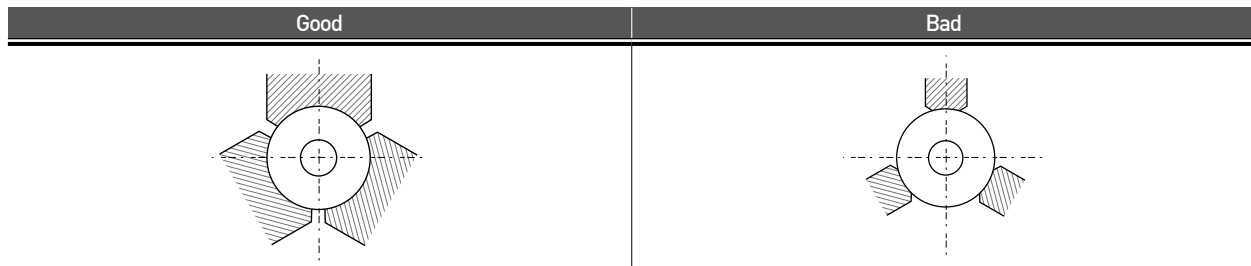

Cylindricity

Perform chucking in the vicinity of machining range

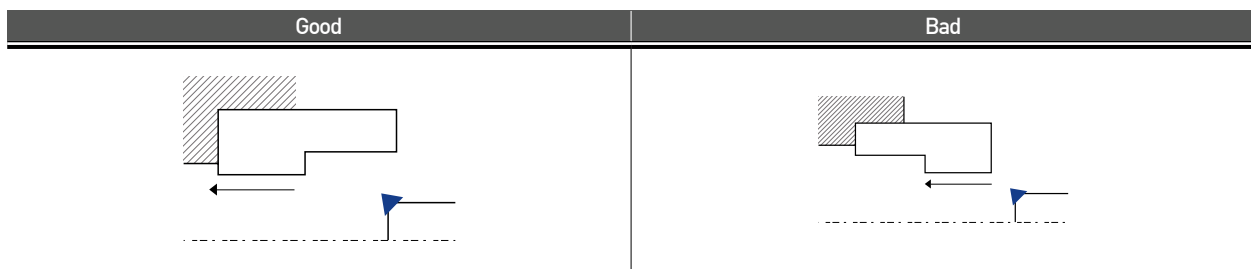

Relationship of chucking pressure and out-of-roundness

Machining conditions

- Machine : General-purpose N/C lathe
- Workpiece : SUJ2 HRC60
- Chuck : 3Jaw
- Tool : DBN250
TPGW160404

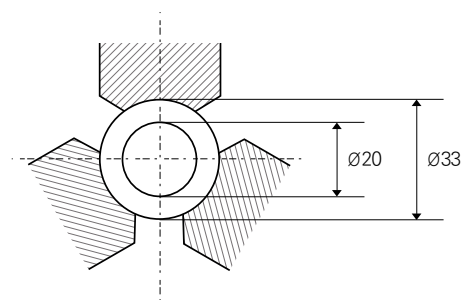

Cutting condition

- $V=150\text{m/min}$
- $f=0.04\text{mm/rev.}$
- $d=0.1\text{mm}$ wet cutting

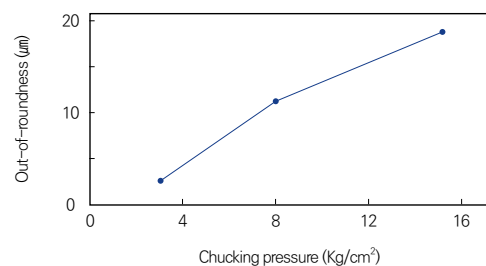

※ An appropriate chuck pressure is necessary for an excellent machining.



cBN Edge treatment

cBN Wiper insert

Shape

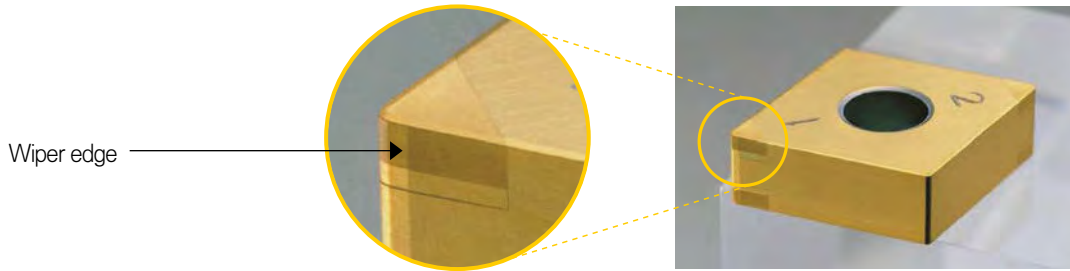

Purpose

CT reduction

Tool service life increased

High surface roughness required

Features and performance of wiper insert

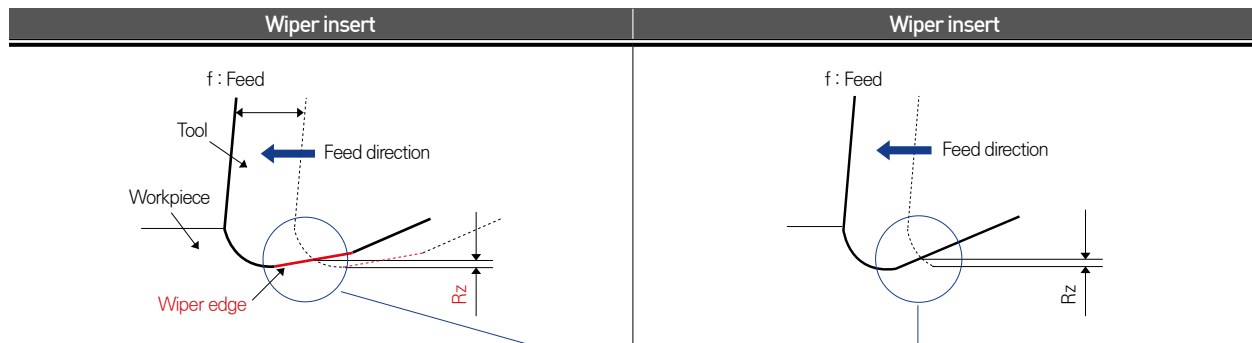

Features

- Surface roughness improved
- High efficiency machining based on high feed (when the surface roughness is the same)

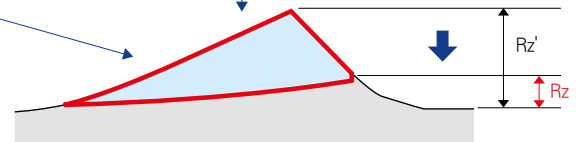

※ According to wiper cutting edge, the surface roughness Rz is getting smaller even in case of cutting with the same feed.

Theoretical surface roughness of wiper insert

Based on the wiper effect, surface roughness was increased 3~5 times on the same conditions!

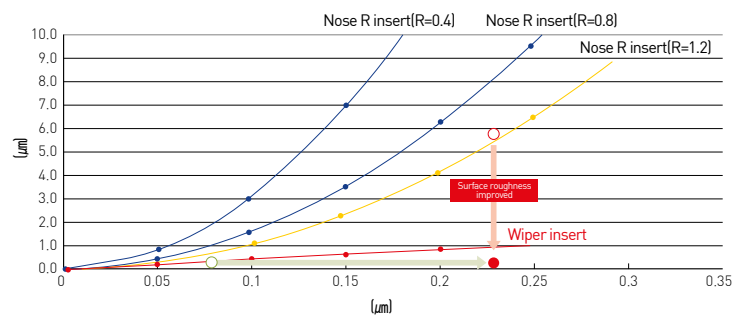

※ The details may vary according to machining environments.



cBN Edge treatment

cBN cutting edge treatment

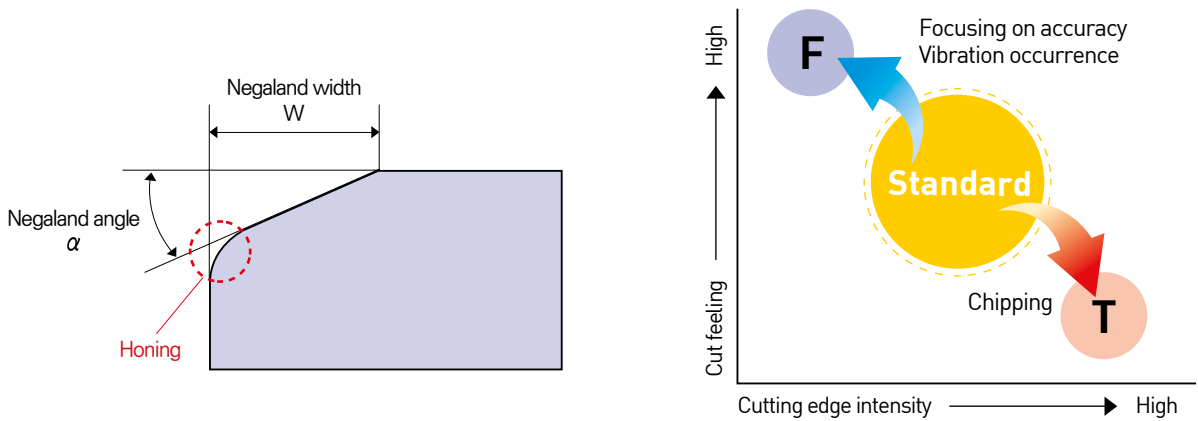

CNGA120408F / CNGA120408 / CNGA120408T

Item	Marking	Heat-treated steel			Cast iron/sintered alloy		
		Honing	Negaland width	Negaland angle	Honing	Negaland width	Negaland angle
Sharp	F	0	0.12	15-degree	-	-	-
Standard*	None	0	0.12	25-degree	N/A	0.12	15-degree
Reinforced	T	0	0.12	35-degree	N/A	0.12	25-degree

- First recommended cutting edge treatment : standard type*
- Apply sharp / reinforcement types according to machining conditions

Adjust Negaland width and angle and honing amount appropriately for machining

Characteristics of cBN honing

- SCM415 $\varnothing 10$ Inner diameter boring 2NU-CNGA120408 DBNX20
- $V=70\text{m/min}$ $f=0.03\text{mm/rev}$ $d=0.05\text{mm}$ DRY
- Giving honing increases cutting resistance to weaken machining accuracy but tends to improve surface roughness.

Comparison of cylindricity as per cutting edge shape

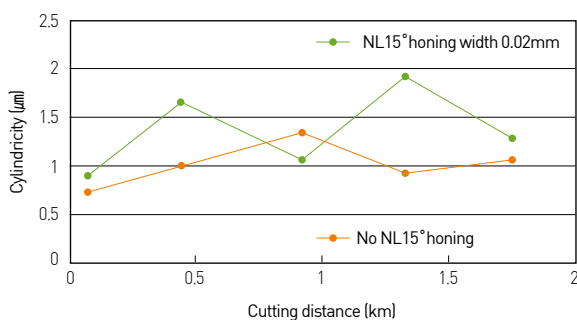

Comparison of surface roughness as per cutting edge shape

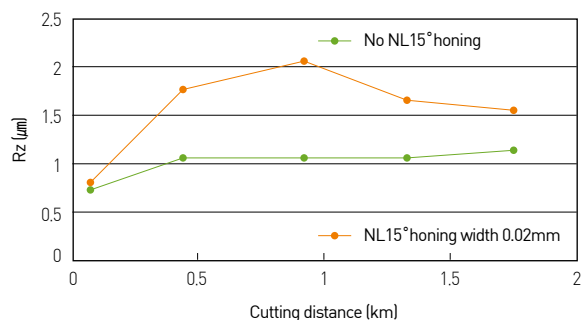

※ The details may vary according to machining environments.



cBN Edge treatment

cBN Test comparison – Negaland

The smaller Negaland angle is, the smaller cutting resistance is.

Comparison of cutting resistance

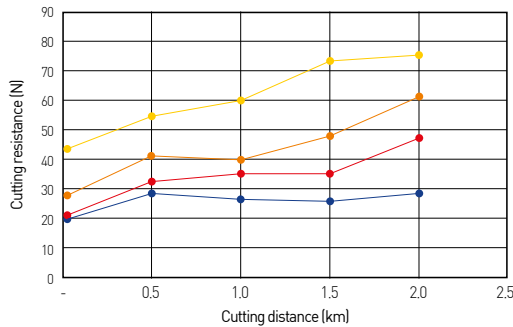

※ TEST information

- Cutting conditions :
 - Vc 90m/min
 - fn 0.06mm/rev
 - ap 0.08mm
- Workpiece : SCM420 (HRC55~57)
- Holder : DCLNR2525
- Insert : CNMA120408 / DBN250
(Standard cutting edge : Negaland angle 25°)

cBN (Effect of Negaland)

Dimensional accuracy

Dimension accuracy increases as the cutting edge angle is getting smaller.

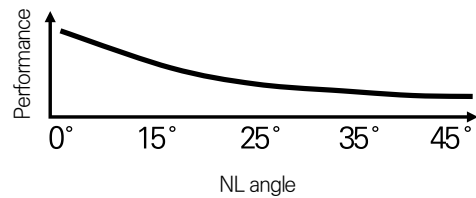

Chipping resistance

Cutting edge strength increases as the cutting edge angle is getting larger.

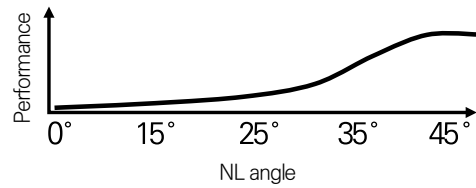

Surface roughness

Surface roughness decreases as the cutting edge angle is getting larger.

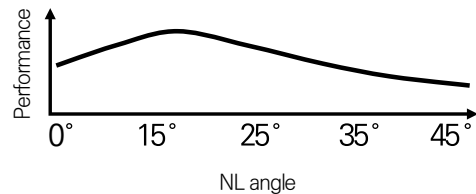



cBN Edge treatment

cBN Test comparison – Cutting edge treatment (standard type/F type/T type)

Workpiece (round bar) information	
Size	∅105X 150
Material	SCM415
Heat treated	Carburization
Hardness	HRC58-62

Insert information 2NU-CNGA120408			
Grade	Cutting edge treatment	Negaland	Honing
DB1000	Standard type	0.12 X 25°	0.010
DB1000	F type	0.12 X 15°	0.010
DB1000	T type	0.12 X 35°	0.010

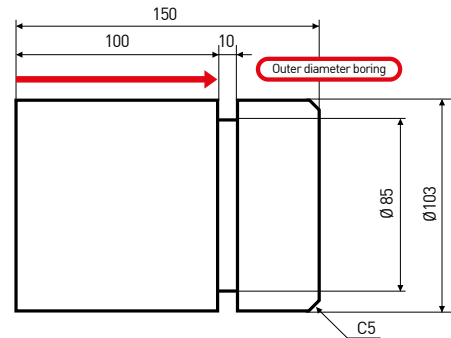

Results analysis

- Wear loss : T type > Standard type > F type
- Surface roughness : Standard type > T type > F type
 - With 20 times of machining, surface roughness is machined at 8/12/20 time.
- Remarks :
 - Theoretically, F type (sharp type) is excellent in surface roughness, but under the machining condition of $V=200/f=0.1/a_p=0.1$, the surface roughness due to initial chipping occurrence of F type is shown inferior.

Comparison of surface roughness			
Grade	8-time machining	12-time machining	20-time machining
DB1000	Ra 0.431	Ra 0.477	Ra 0.492
DB1000F	Ra 0.629	Ra 0.754	Ra 0.821
DB1000T	Ra 0.496	Ra 0.545	Ra 0.584

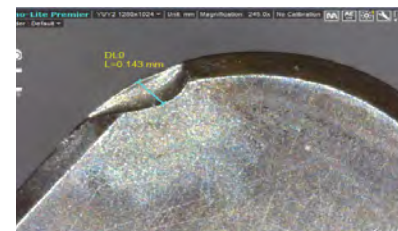
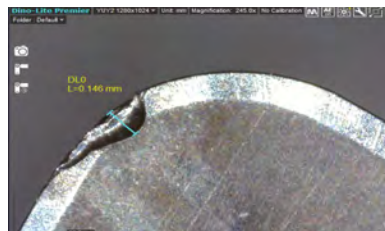
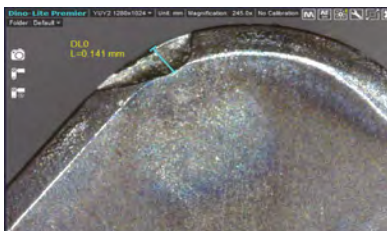
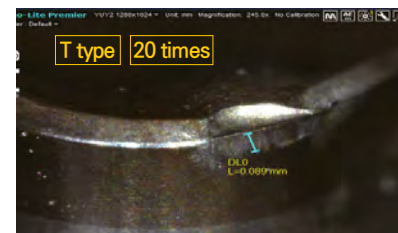
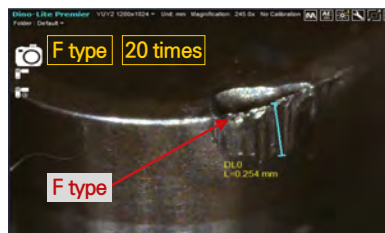
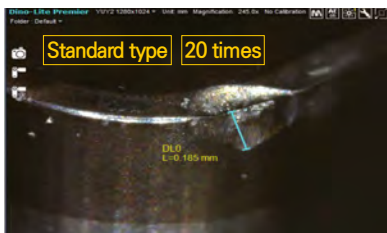



cBN Re-grinding

How to select re-grinding

1. Check for abnormality or brokenness through inspection
2. Classify re-grinding according to the size of an inscribed circle

Model No.	New product (before use)	Class B	Class C	Class D
CNMA1204□□	12.7	12.5	12.3	12.1
DNMA1504□□	12.7	12.5	12.3	12.1
VNMA1504□□	9.525	9.4	9.3	9.2
DCGW11T3□□	9.525	9.3	9.1	X
CCGW09T3□□	9.525	9.3	9.1	X

Machining example

CNMA120408 → 0.2mm machined at one time machining

New product (before use) : Regrinding 0 time, inscribed circle 12.7mm

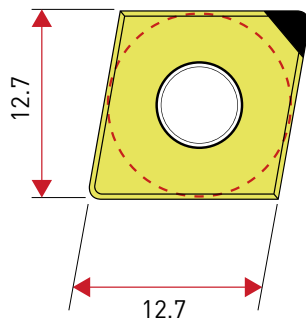

Class B : Regrinding 1 time, inscribed circle 12.5mm

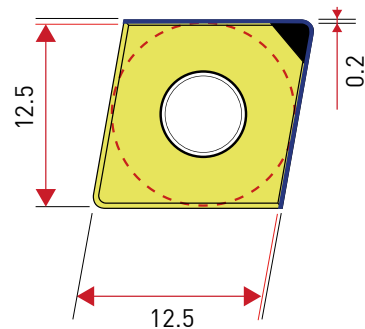

Class C : Regrinding 2 times, inscribed circle 12.3mm

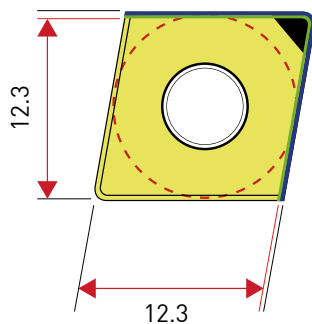

Class D : Regrinding 3 times, inscribed circle 12.1mm

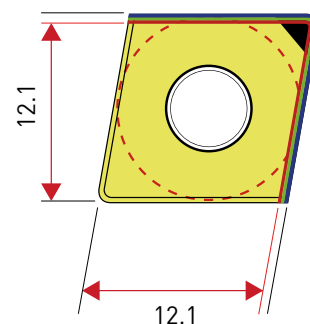



PCD Chip Breaker(UC)

New PCD insert with Chip Breaker

Features

- Productivity improved by resolving chip troubles
- Stable capacity to break chips in the large cutting area
- Excellent in machining aluminium and copper alloys
- Provides very high hardness and excellent wear resistance due to high-density combination of diamond polycrystallines

Performance Comparison Test

- Tool model no. : DCMT11T304-UC
- Workpiece : AL6061 (\varnothing 100*160L outer dia. boring)
- Cutting conditions : $V_c=500\text{m/min}$, $f=0.15\text{mm/rev}$, $a_p=0.2\text{mm}$, dry cutting

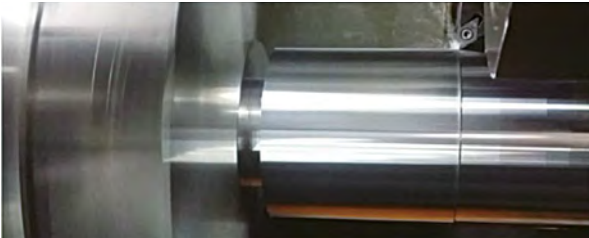

General type PCD



UC Chip breaker

Chip Breaker

UC Chip Breaker

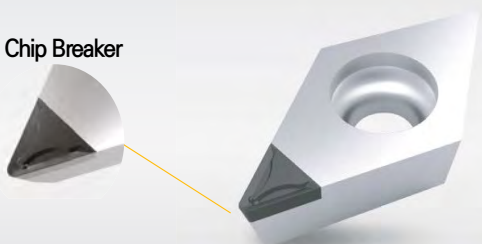

※ Excellent chip breaker design to easily make a curl

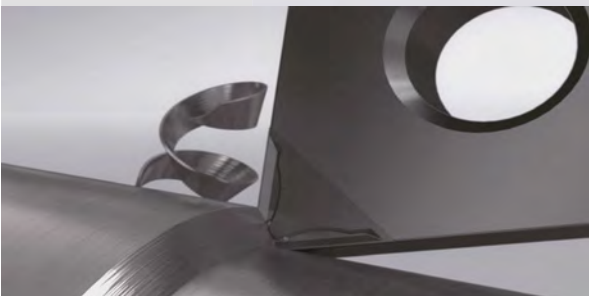

Applicable area

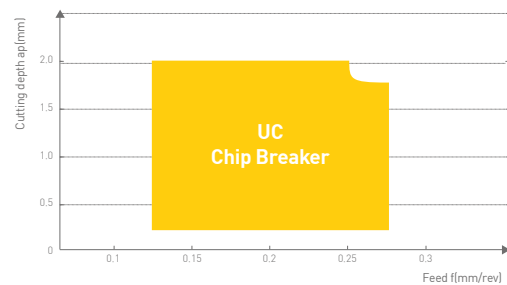

Shape of chip

- Tool model no. : DCMT11T304-UC
- Workpiece : AL6061 (\varnothing 100*160L outer dia. boring)
- Cutting conditions : $V_c=500\text{m/min}$ dry cutting

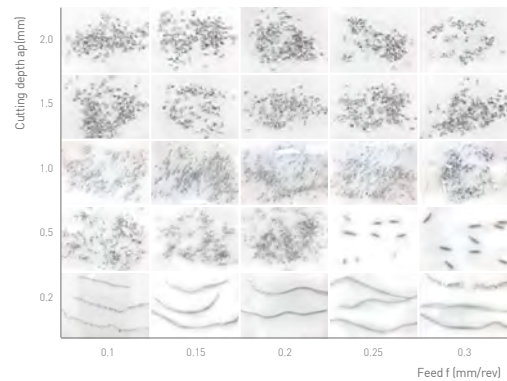

Comparison of chip rear discharge

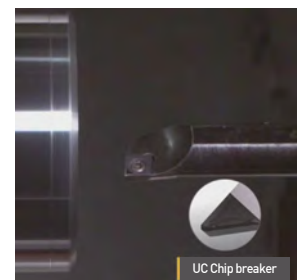
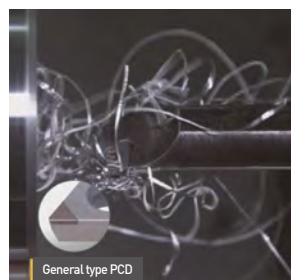



cBN Technical data

PCD Features

DINE PCD products provide very high accuracy and excellent wear resistance as they are manufactured by the ultrahigh temperature and ultrahigh pressure manufacturing process to combine diamond polycrystallines in high density.

Also as the PCD products are based on the diamond crystal particle size control technology by DINE Inc., various workpieces can be machined widely. DINE PCD products provide excellent workpiece surface roughness, high machining accuracy and long tool service life.

- Excellent in machining aluminium alloys and copper alloys
- Excellent in machining ceramic, high Si-aluminium alloy, stone, etc.
- Excellent in machining rubber, carbon, graphite, wood, etc.

PCD Shape



TNMX

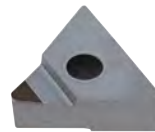

CCMT

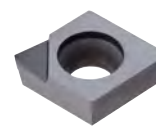

SPGN

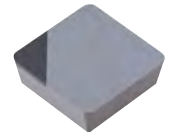

PCD Tool technology guide

1. PCD = polycrystalline diamond = particle sintered diamond
2. Composition : [diamond crystal grain + diamond additives (metal, ceramic)]
sintering by high temperature and pressure (1200°C, 50k atm)
3. Particle size : ultrafine particle (0.5µm) < fine-grained particle (10µm) < rough particle (more than 25µm)

ultrafine particle(0.5µm)



fine-grained particle (10µm)

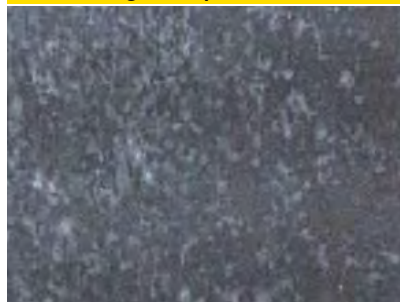

rough particle (more than 25µm)

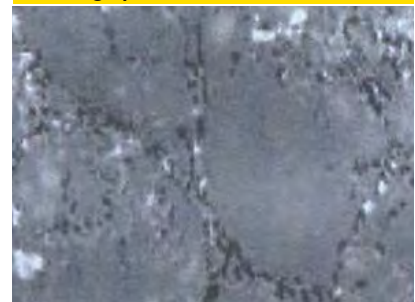

4. Application : nonferrous metals, glass fiber, woodwork, high-hardness plastic
5. Specification
 - 1) rough particle => high density and thermal conductivity – excellent wear resistance but weak surface roughness.
 - 2) Cutting edge oxidation occurs in case of machining high-hardness materials at low oxidation temperature



PCD Technical data

PCD

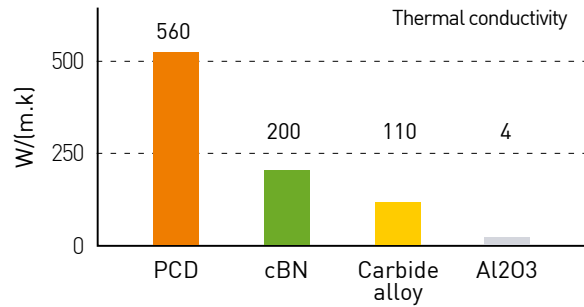
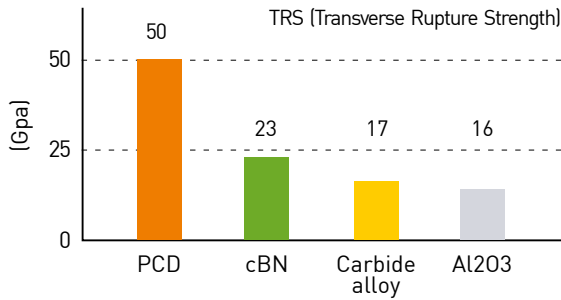

Comparison of cBN and PCD

		cBN	PCD
Thermal stability	In atmosphere	Stable up to ~1300°C	Oxidation occurs at 700°C
	In vacuum	Stable up to ~1500°C	Stable up to ~1400°C
Applications		Heat-treated steel, high-hardness materials	Nonferrous metals, glass fiber, woodwork, high-hardness plastic

PCD Grade

Grade	Features	Applications	Particle size (μm)	Particle	Hardness (Hv)	Deflective strength (kgf/mm ²)
DP90	The largest grade diamond content by sintering rough diamond particles; Excellent wear resistance	High silicon Al alloy machining, Al composite material machining, cemented carbide alloy machining, rough boring of cemented carbide alloy, ceramic semi-sintered parts, and compound products, ceramic sintered parts machining, stone and rock machining	≥25		10,000 ~ 12,000	110
DP150	The same-size grade diamond particle by sintering finegrained diamond particles; good coherent grade with workpiece machinability and wear resistance	General grinding machining of nonferrous metals; grinding surface machining of cemented carbide alloys, ceramic sintered parts, and compound products; crosssectional machining of FRP, hard rubber, graphite, wood, and mineral board, etc.	10		10,000 ~ 12,000	200
DP200	Good sharpness and excellent tenacity of grade cutting edge by sintering ultrafine diamond particles	General grinding machining of nonferrous metals; grinding surface machining of cemented carbide alloys, ceramic sintered parts, and compound products; crosssectional machining of FRP, hard rubber, graphite, wood, and mineral board, etc.	0.5		8,000 ~ 10,000	220



PCD Technical data

Machining example

Workpiece	Cutting speed	Feed	Single cutting depth	Recommended grade	
				1st	2nd
Aluminium alloy (4%~8%Si)	1,000~3,000	0.1~0.6	~3	DP150	DP200
Aluminium alloy (9%~14%Si)	600~2,500	0.1~0.5	~3	DP150	DP200
Aluminium alloy (15%~18%Si)	300~700	0.1~0.4	~3	DP150	DP200
Copper alloy	~1,000	0.05~0.2	~3	DP150	DP200
Reinforced plastic	~1,000	0.1~0.3	~2	DP150	DP200
Wood	~4,000	0.1~0.4	-	DP150	DP200
Cemented carbide	10~30	~0.2	~0.5	DP90	DP150

Continuous cutting test(workpiece:Al-25%Si)

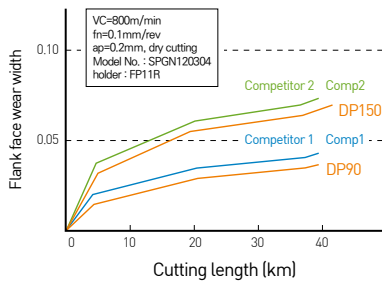

Interrupted cutting test(workpiece:Al-20%Si)

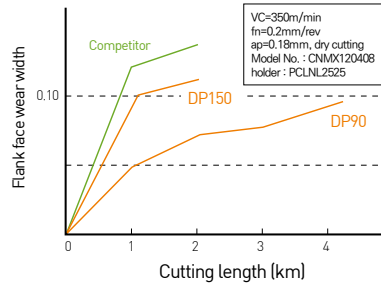

Continuous cutting test(workpiece:Al-25%Si)

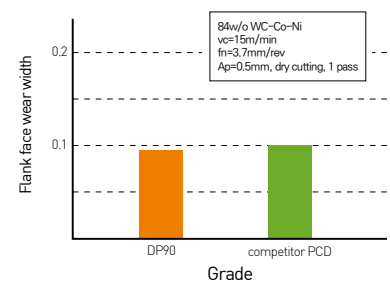

Machining example

DP150 TEST RESULT

Grade	DP150	Company A PCD
INSERTS	DCMT11T304-UC	
Parts name (workpiece)	Compressor piston (AL A4000)	
Vc(m/min)	400-450	
f(mm/rev)	0.12	
ap(mm)	1.0 ~ 1.5	
Dry/wet cutting	Wet cutting	

DP200 TEST RESULT

Grade	DP200	Company A PCD
INSERTS	NF-SEN09T3ADTR	
Parts name (workpiece)	Ring spec. outer diameter (AL6061)	
Vc(m/min)	380	
f(mm/rev)	0.1	
ap(mm)	0.15	
Dry/wet cutting	Dry/wet cutting	

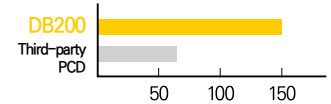
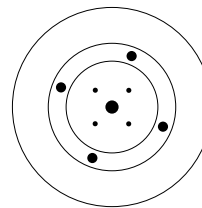
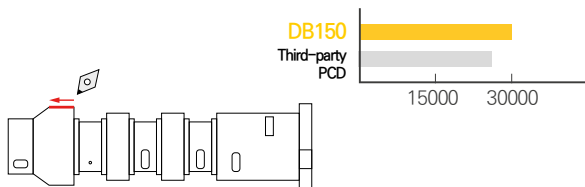



How to indicate the Model No. of Insert

How to indicate cBN cutting edge

Model No. example

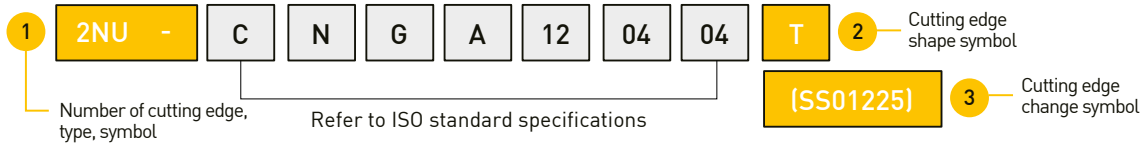

① Number of cutting edge, type symbol

Symbol	Symbol	Symbol description
Number of cutting edge	None	1 corner type
	2, 3, 4 ...	multi-corner type

Symbol	Symbol	Symbol description	Shape
Type Symbol	None	Re-grinding type	
	NU	One use type, corner type	
	NT	NT type	

② Cutting edge shape symbol

Symbol	Symbol meaning	Symbol description		
None	Standard type	ISO standard insert		
F	Low resistance type	Workpiece	Standard	F
		Heat-treated steel grade	25°	15°
		Cast iron grade	15°	0°
		Wiper insert	15°	-
T	Cutting edge reinforced type	Workpiece	Standard	T
		Heat-treated steel grade	25°	35°
		Cast iron grade	15°	25°
		Wiper insert	15°	25°
W	Wiper type	Wiper insert		
-GA -RA	Chip breaker type	-GA : fine-boring chip breaker -RA : rough-boring chip breaker		

③ Cutting edge change symbol

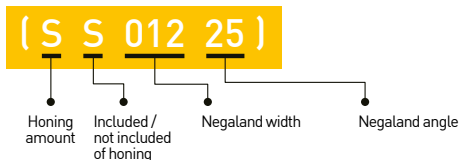

Honing amount		Honing		Negaland width	Negaland angle
S	Small	S	Existence	12	25
M	Medium	T	Non-existence	-	-
L	Large				

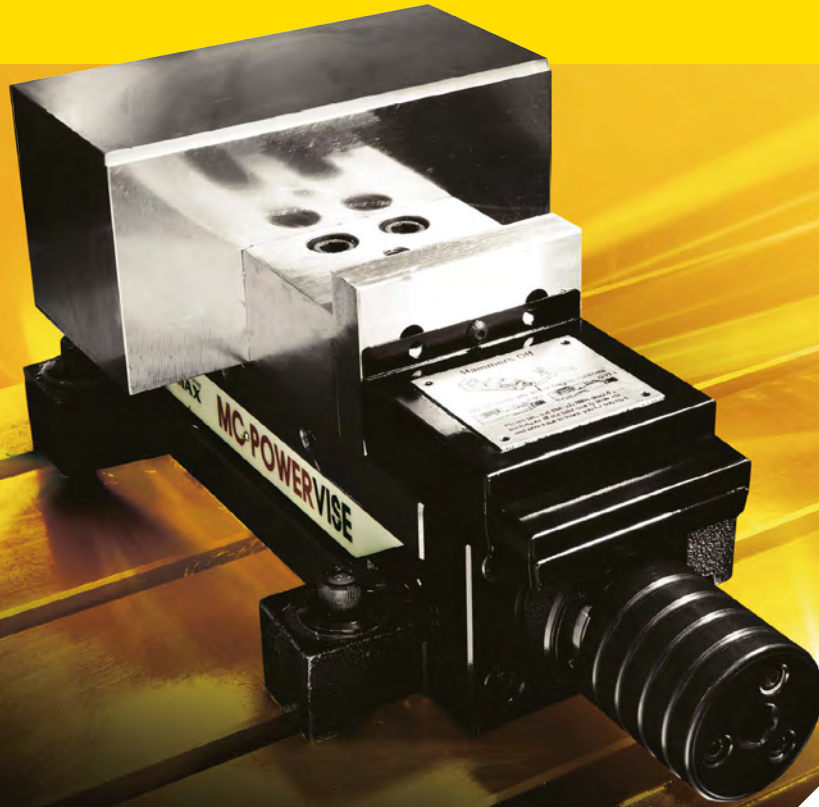

TAUMAX

DINOX NC TOTAL TOOLING SYSTEM

Power vise(PVT)	294
Power vise(PVTM)	295
Doublelock & Anglock vise(DVT)	297
Mc Machine vise(MVT-154)	297
5-Axis Centering vise(FVT)	298
Taper cleaner	300
Shrink fit device	301
Clean-tec-fan	302
Precise boring adjustment cartridge	303
Pull stud bolt wrench	303
Tool clamp	304
Magnetic base	305



Power Vise (PVT)

MC POWER VISE - PVT (standard type)

Features

- Apparatus type power increase device adopted
- Designed to minimize workpiece floating
- Height tolerance : 0.01mm, Can be used in parallel
- Built-in IN (18T) sub-jaw
- Durability enhanced by using high stiffness

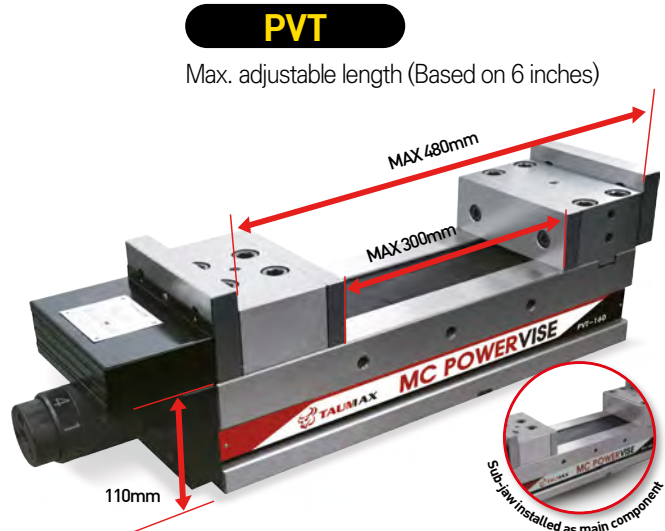

How to use

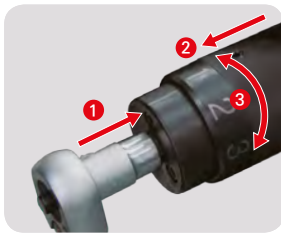

- ① Fix the grip after tightening by the main handle
- ② Pull the clamping force control grip toward the handle
- ③ Rotate the clamping force control grip from side to side to set the clamping force.

Clamping force

Grasp step	Spec	PVT-100	PVT-130	PVT-160	PVT-200
Step 1		1,000	1,500	2,000	2,500
Step 2		2,000	2,500	3,000	3,500
Step 3		3,000	3,500	4,000	4,500
Step 4		3,500	4,500	5,000	5,500

(Unit : kgf)

Main components

Handle	Ratchet handle	Internal sub-jaw	Accessory

※ IN/OUT Sub-jaw is the same, available as PVTM Entry Type.

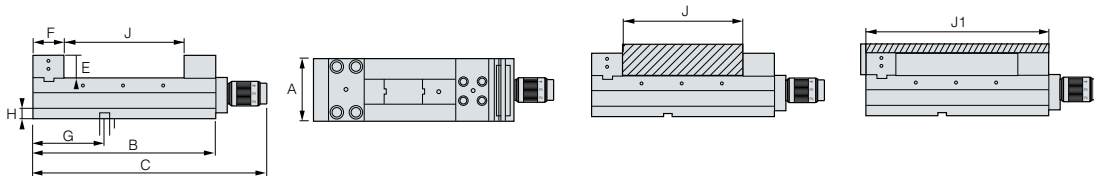

Model No.	A	B	C	D	E	F	G	H	I	J	J1	Clamping force (Kgf)	Kg
PVT-100	100	310	442	85	50	75	110	25	18	150	300	3,500	29
PVT-130	130	410	542	100	55	80	135	25	18	240	400	4,500	46
PVT-160	160	490	622	110	60	85	200	25	18	300	480	5,000	68
PVT-200	200	530	662	110	60	85	220	25	18	350	520	5,000	91



Power Vise (PVTM)

MC POWER VISE - PVTM (entry type)

Features

- Easy-to-use entry type power vise
- Apparatus type power increase device adopted
- Height tolerance : 0.01mm, Can be used in parallel
- Built-in IN (18T) sub-jaw

PVT

Max. adjustable length (Based on 6 inches)

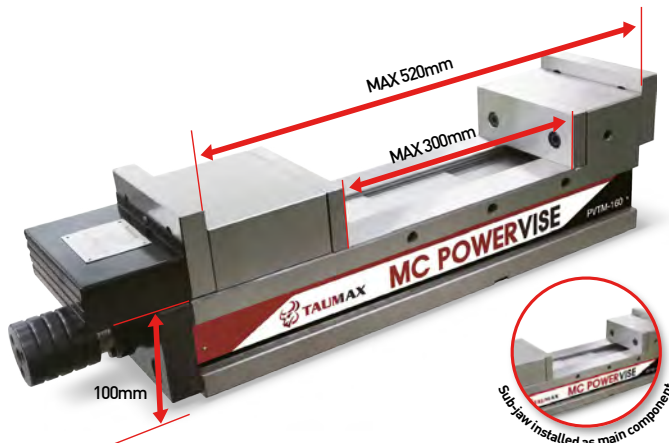

How to use

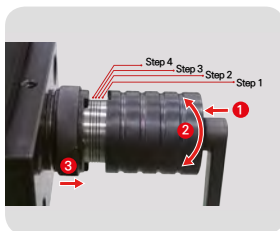

① Push it to the workpiece using the ratchet handle, a main component ② Apply instantaneous torque(rotation) to increase grasping power Pull out the workpiece by turning the ratchet handle in the opposite direction after machining ③ Be sure to use the clutch to clamp any hard workpiece (mild steel, aluminium, copper, acryl, etc). Otherwise, the material of the workpiece may be strained.

Clamping force

Grasp step	Spec	PVTM-100	PVTM-130	PVTM-160	PVTM-200
Step 1		1,500	2,000	2,000	2,000
Step 2		2,500	3,000	3,000	3,000
Step 3		3,000	4,000	4,000	4,000
Step 4		3,500	4,500	5,000	5,000

(Unit : kgf)

Main components

Handle	Ratchet handle	Internal sub-jaw	Accessory

※ IN/OUT Sub-jaw is the same, available as PVTM Entry Type.

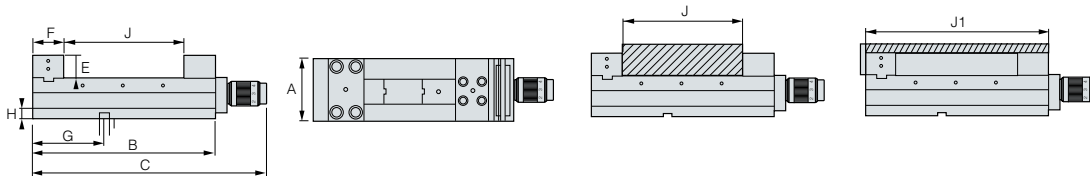

Model No.	A	B	C	D	E	F	G	H	I	J	J1	Clamping force (Kgf)	Kg
PVTM-100	100	310	442	85	50	75	110	25	18	150	300	3,500	29
PVTM-130	130	410	542	100	55	80	135	25	18	240	400	4,500	46
PVTM-160	160	490	622	110	60	85	200	25	18	300	480	5,000	68
PVTM-200	200	530	662	110	60	85	220	25	18	350	520	5,000	91



ACCESSORIES

ACCESSORIES

Guide key

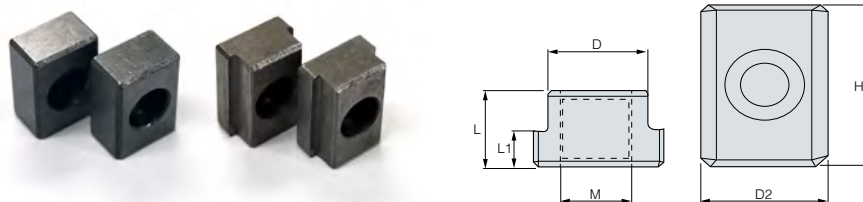

Model No.	D	D1	H	M	L	L1
KEY-14MM+CAP-M6*P1.0*12L	14	18	25	M6	12	6
KEY-18MM+CAP-M6*P1.0*12L	18	-	25	M6	12	6

(Unit : mm)

IN/OUT sub-jaw & Movable jaw/Fixed jaw

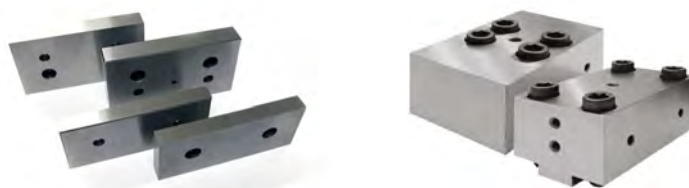

Item	Model No.	Compatibility classification
IN/OUT sub-jaw	PVT-□□□ INSIDE JAWS	PVT/M
	PVT-□□□ OUTSIDE JAWS	PVT/M
Fixed jaw	PVT-□□□ FIXED BLOCK	PVT
Movable jaw	PVT-□□□ SLIDER BLOCK	PVT

※ Sub-jaw specifications are the same as the specifications included in the conventional vise.

※ OUT sub-jaws are for separate purchase.

T-nut & Bolt

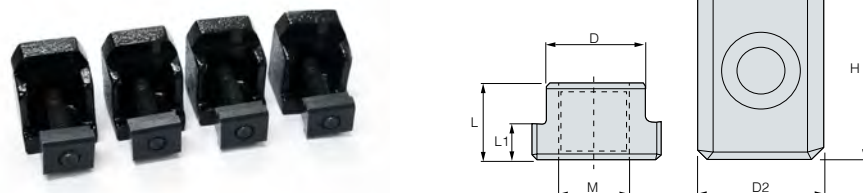

Model No.	D	D2	H	M	L	L1	Compatibility classification	Components
T-nut & Bolt	13.8	22	28	M12*1.75(S)	16	8	PVT/M-100	T-NUT/ 4 pcs. Each washer clamp/ bolt
	15.5	25	28	M12*1.75(M)	16	8	PVT/M-100,130	
	17.5	28	31	M12*1.75(L)	19	11	PVT/M-160,200	

※ For other keys and T nut specifications, please contact us for the quotation separately.

(Unit : mm)



DOUBLE LOCK & ANGLOCK VISE (DVT)

DOUBLE LOCK & ANGLOCK VISE - DVT

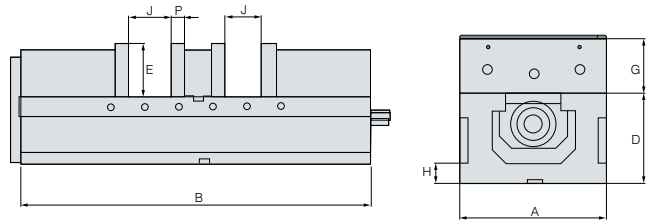

Features

- 5 ways of clamping by changing jaws position
- Max opening 70mm for 2 pieces clamping, 136mm max for single piece clamping
- High hardened / Heat treated steel body with HRC hardness 50, height tolerance 0.01mm
- Anti-lifting structure

(Unit : mm)

Model No.	A	B	D	E	G
DVT-160	160	500	160	63	60
Model No.	H	P	J	Kg	-
DVT-160	23	18	70	64	-

Main Components

Inside jaws	Wrench	T-clamp set x4, Guide key x2	Block, Screws * 6



MC MACHINE VISE-MVT (MVT-154)

MC MACHINE VISE - MVT

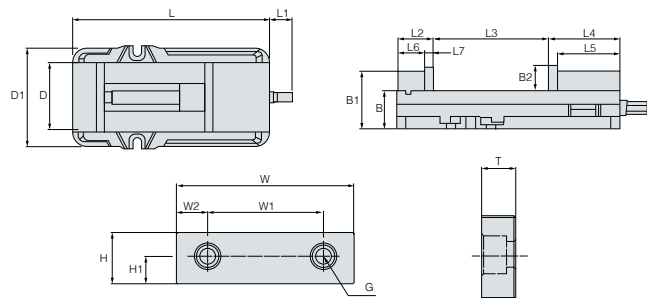

Features

- Handy for use, versatile
- Max opening 8.9"
- Durability improved with hard materials
- Height tolerance considered, Can be used in parallel

(Unit : mm)

Model No.	L	L1	L2	L3	L4	L5	L6	L7
MVT-154	438	56	70	225	141	123	52	18
Model No.	D	D1	B	B1	B2	Width	Max.CF	Kgs
MVT-154	154	230	73	111	44.5	154(6")	1,000kgF	31

Main Components

Wrench	Inside jaws

(Unit : mm)

Model No.	W	W1	W2	H	H1	G	T
MVT-154 Sub jaws	152	98.4	26.7	44.5	23.8	M12x1.75P	18



5-AXIS CENTERING VISE - FVT

5-AXIS CENTERING VISE - FVT

Features

- Best economic clamping solution for 5-Axis machining
- Heat treated / High alloy steel base structure to provide excellent wear-resistance and high anti-tension
- Optimized to be used on high-quality machining process
- Jaws are NOT basically included, jaws can be choosed on demand
- Maximum clamping force 1,200kgF at 75kN
- height tolerance within 0.01mm
- Repeatability within 0.01mm or less for versatile and high level machining
- Easy to assemble and disassemble thanks to its modular structure



Main Components

Self-Centering Vise	Wrench, T-clamp set x4, Guide key x2	User manual

Features

handy replace of parts thanks to modular structure	minimized interference	wide variety of jaws

※ Jaws are not included in Vise, so please choose types of jaws which you are going to use.

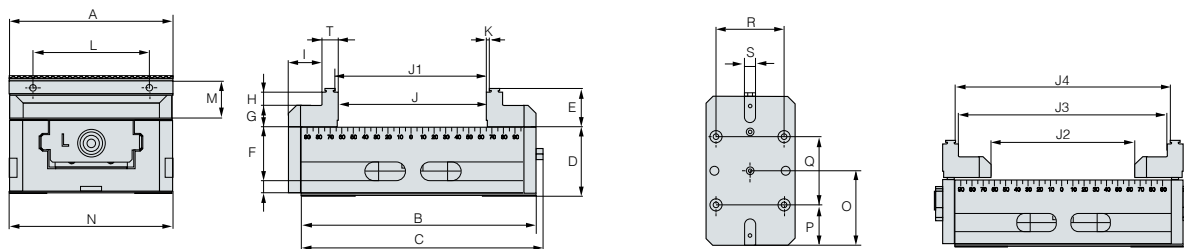

Model No.	A	B	C	D	E	F	G	H	I	T	K	L	M
FVT-77	77	130	135	38	27	10	13	11	23	12	3	135	19
FVT-125	125	210	215	57	32	12	18	11	28	14	3	90	24
Model No.	N	O	P	Q	R	S	J	J1	J2	J3	J4	Max.CF	Kgs
FVT-77	78	65	39	52	52	16	60	66	60	106	112	1,000	4
FVT-125	126	104	57	96	96	16	126	132	126	182	188	1,500	11

(Unit : mm)



ACCESSORIES

Serrated Jaws

Serrated Jaws



Single Serrated Jaws

- Teeth height 3mm
- Material : SCM 440
- Versatile
- Minimize interference and excellent clamping assistance thanks to its serrate

3 Steps Serrated Jaws

- Teeth height 7mm
- Material : SCM440
- Effective on thick and heavy weight material

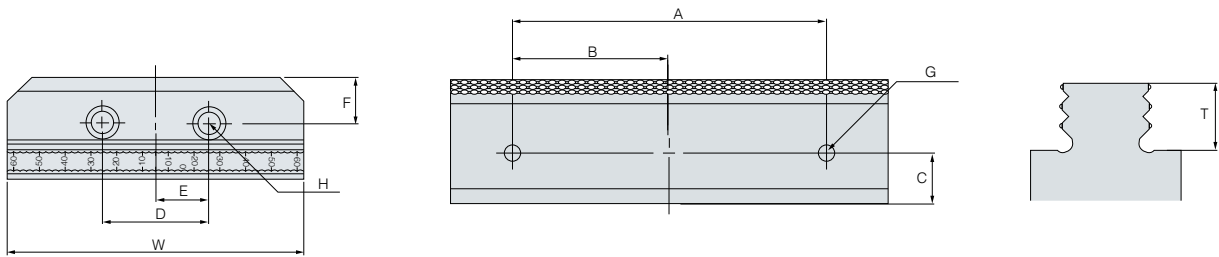

For	Model No.	A	B	C	D	E	F	G	H	T	W	Material
FVT-77	Single Serrated Jaws	60	30	16	24	12	16	M4x0.7	Ø6.5	3	77	SCM440
	3 Steps Serrated Jaws	60	30	16	24	12	16	M4x0.7	Ø6.5	7	77	SCM440
	General Jaws	60	30	16	24	12	34.5	M4x0.7	Ø6.5	27	77	Steel / Al
FVT-125	Single Serrated Jaws	90	45	15	45	22.5	19	M5x0.8	Ø9	3	125	SCM440
	3 Steps Serrated Jaws	90	45	15	45	22.5	19	M5x0.8	Ø9	7	125	SCM440
	General Jaws	90	30	15	45	22.5	35	M5x0.8	Ø9	32	125	Steel / Al

(Unit : mm)

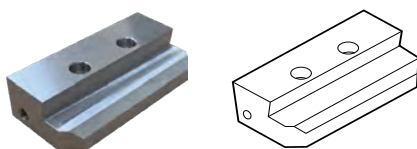

General Jaws (AI-6061)

- Material : AI-6061
- Both sides available for use
- For soft material
- Anti-lifting design
- Customer can customize easily as necessary
- Wide width 60mm for user customizing

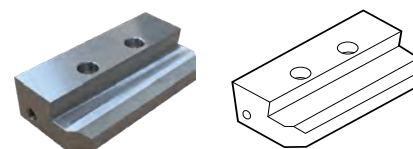

General Jaws (SCM440)

- Material : SCM440
- Both sides available for use
- For general material clamping
- Anti-lifting design
- Customer can customize as necessary
- Wide width 60mm for user customizing

1:1 CHAT



TAPER CLEANING DEVICE

Taper Cleaning Device

Features

- Improves accuracy by cleaning Taper
- Increases the life cycle of tool
- Protects the spindle of equipment
- Maintains accuracy of the contact surface for a long time
- Compact design and Timer function



Item	Model No.	Diameter	Height	Kg	Power supply	Power consumption	Specifications
Lower basis	Taper cleaning drive unit	300	140	11	110-240 VAC	Max. 0.15kW	-
Upper cleaning part	Cleaning attachment ISO 30	230	160-190	10			BT/SK/CAT30
	Cleaning attachment ISO 40	230	160-190	10			BT/SK/CAT40
	Cleaning attachment ISO 50	230	160-190	10			BT/SK/CAT50
	Cleaning attachment HSK-63	230	160-190	10			HSK-63
	Cleaning attachment HSK-100	230	160-190	10			HSK-100

(Unit : mm)

1:1 CHAT



ACCESSORIES

ACCESSORIES

Item	Model No.	Specifications
Spare brush	Spare brush ISO 30	BT/SK/CAT30
	Spare brush ISO 40	BT/SK/CAT40
	Spare brush ISO 50	BT/SK/CAT50
	Spare brush HSK-63	HSK-63
	Spare brush HSK-100	HSK-100





MH-200

Shrink fit device

Features

- 30-time continuous heating available for a maximum of 1 hour (about 2 min. per tool required)
- Enables the common use of steel, SUS material holders
- All standard taper tools can be used simply by replacing the tool mounting adapter
- Enables replacement of heating coils with a diameter of Ø25, Ø30, Ø40 or Ø55
- Prevents chuck overheating and enables manual tool cooling through settings

Easy usage setting



MH-200 Operating keypad	START/STOP	Heating start/stop switch
	SET-TIME	Heating time/cooling time setting
	ADD-TIME	Overtime manual progress
	COOL	Cooling device running
	UP/DOWN	10-second unit time setting



Model No.	WxLxH(mm)	Kg	Power supply	Max. power consumption	Frequency	Head operating range	Basic applicable tool diameter
MH-200	325x340x690	25	single-phase AC 100V~240V(50.6Hz)	2.0Kw (220V basis)	7KHz~45KHz	280	Ø4~Ø16

(Unit : mm)



ACCESSORIES

ACCESSORIES

Item	Model No.	Inner size
Heating coil	HEATING COIL-25MM	25
	HEATING COIL-30MM	30
	HEATING COIL-40MM	40
	HEATING COIL-55MM	55
Tool mounting adapter	ST10,12,16,20,25,32	-

※ Built-in Ø30 heating coil

(Unit : mm)

Heating coil

Ø55 Ø40 Ø30 Ø25



Tool mounting adapter

Basic Accessory



1:1 CHAT



CLEAN-TEC FAN

Cleaning Fan

Features

- Productivity improved as cleaning is possible without opening the CNC machine door
- The operator's safety improved as no compressed air is blown
- Electricity cost reduction due to a reduced use of compressed air
- Can be installed in ATC; production efficiency increased



Model No.	ØD(Unfolded)	Ø Shank	Max.RPM	Kg
Clean-Tec 160	160	20	12,000	0.2
Clean-Tec 260	260	20	8,000	0.2
Clean-Tec 330	330	20	8,000	0.5

(Unit : mm)

1:1 CHAT



ACCESSORIES

ACCESSORIES



Usage related photo



Model No.	Components	Compatible specifications
Spare Part Kit for Clean-Tec 160	4 wings / spring	Clean-Tec 160
Spare Part Kit for Clean-Tec 260	4 wings / spring	Clean-Tec 260
Spare Part Kit for Clean-Tec 330	4 wings / spring	Clean-Tec 330



PRECISION MICRO ADJUSTING CARTRIDGE

Precision micro adjusting cartridge

Features

- Both left-hand and right-hand versions available, internal coolant type
- Available minimum boring diameter: 28.00mm
- 90-degree, 95-degree lead angle versions
- Unit diameter adjustable up to 0.01mm within the radial adjustment 0.3mm (1 gradation adjustment radius: 0.005mm)
- Axial range adjustable : 1.0mm

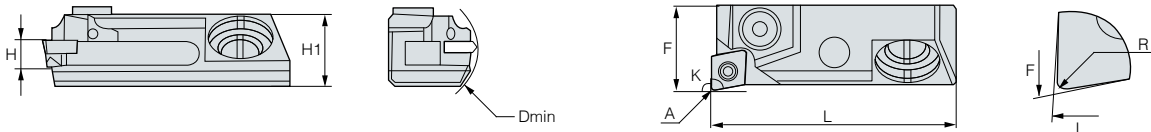

Model No.	K	H	F	L	H1	Dmin	R	Applicable insert
TMCR/L90-F16-CC06	90	8.8	16	45.8	13.5	28	0.4	CC..0602..
TMCR/L95-F16-CC06	95	8.8	16	45.8	13.5	28	0.4	CC..0602..
TMCR/L90-F16-TP09	90	8.8	16	45.8	13.5	28	0.4	TP..0902..
TMCR/L95-F16-TP09	95	8.8	16	45.8	13.5	28	0.4	TP..0902..
TMCR/L90-F20-TC11	90	8.8	20	45.8	13.5	36	0.4	TC..1102..
TMCR/L95-F20-TC11	95	8.8	20	45.8	13.5	36	0.4	TC..1102..
TMCR/L90-F20-TP11	90	8.8	20	45.8	13.5	36	0.4	TP..1103..
TMCR/L95-F20-TP11	95	8.8	20	45.8	13.5	36	0.4	TP..1103..
TMCR90-L22-CC09	90	7.5	22	54.8	17.0	40	0.4	CC..09
TMCR120-L16-DC07	120	5.0	16	48.6	13.5	28	0.4	DC..07

(Unit : mm)



Pullstud Bolt Wrench

Pullstud bolt Wrench

Work fatigue reduced by using the pullstud bolt dedicated wrench

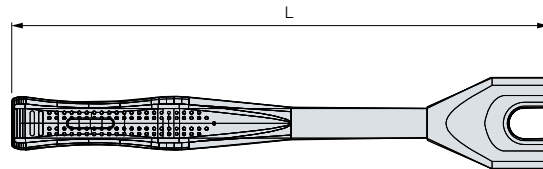
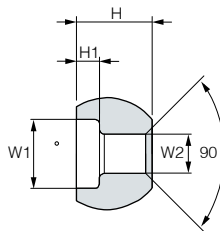

Model No.	L	H	H1	W1	W2	Torque	Kg	Application
PSBW-30	210	16	5	13	7.0	≤80	0.31	BT30
PSBW-40	230	25	6	19	10.0	≤150	0.43	BT40
PSBW-50	280	33	10	30	17.0	≤280	0.84	BT50
PSBW-40(PS-805)	230	20.5	7	19	14.0	≤150	0.43	JISB6339-B40
PSBW-40(PS-G51)	240	19	5	19	13.0	≤150	0.43	Mazak BT40
PSBW-50(PS-G41)	290	17	8	30	21.0	≤280	0.41	Mazak BT50

(Unit : mm)



TOOL CLAMP

Tool Clamp

Features

- For cutting tool and pullstud bolt tightening
- Enables more convenient and easier tightening in case of tool tightening using a 45-degree type
- Provides work stability by heavier load (3kg) than rival products

Example of use

The tool clamp helps tighten the tool by fixing it.

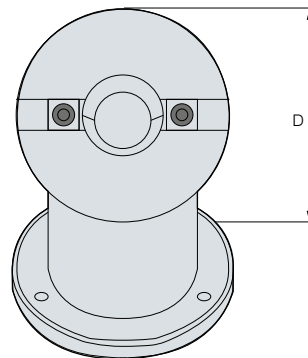
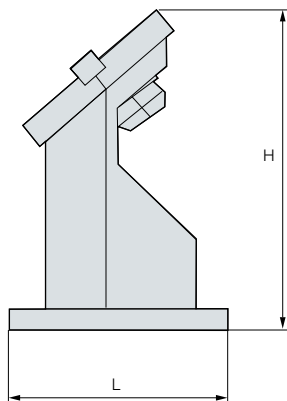

Model No.	Applicable shank	L	H	D	Kg
TTC30	BT30, NT30	119	169	114	3
TTC40	BT40, NT40	119	169	114	3
TTC50	BT50, NT50	119	169	114	3

(Unit : mm)



MAGNETIC BASE

MAGNETIC BASE

Features

- Strong adsorptive power (80Kgf)
- Smooth and precise joint movement
- Ensures lightness and precision as a multi-joint model with a full aluminium body

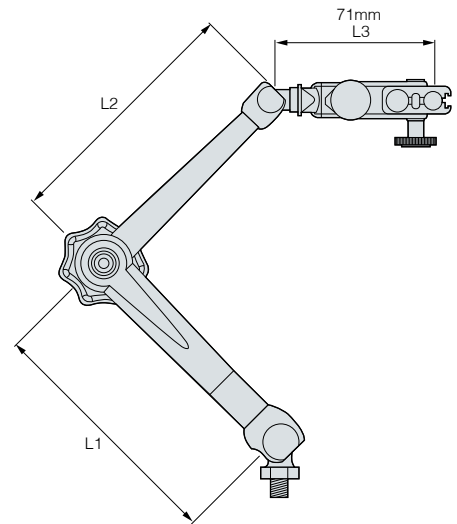
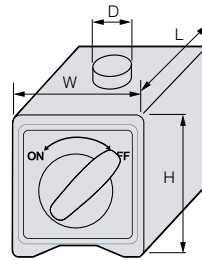
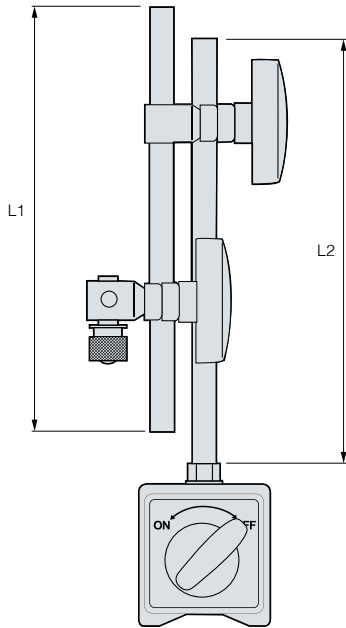
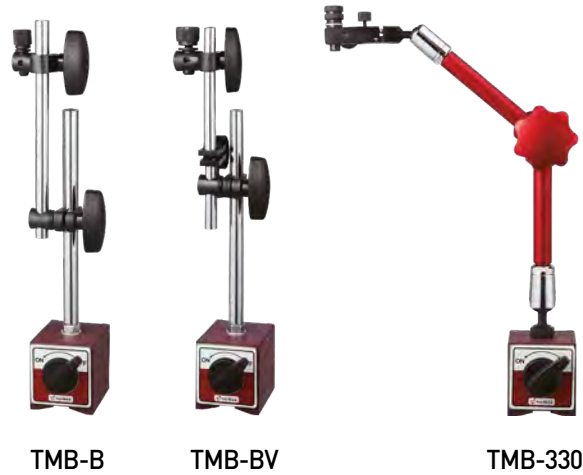

Model No.	Type	Adsorptive power (Kgf)	L1	L2	L3	(L*W*H)	D	Weight (Kg)
TMB-B	160	80	170*Ø12	160*Ø10	-	60*50*55	M8*1.25	1.6
TMB-BV	180	80	170*Ø12	160*Ø10	-	60*50*55	M8*1.25	1.7
TMB-330	330	80	130*Ø12	130*Ø10	71	60*50*55	M8*1.25	1.5

※ For additional purchase of the base and TMB-B holder, please contact us.

(Unit : mm)

Chuck

Arbor/Modular

Boring tool

Angular head

CBN/PCD

TAUMAX

Other



Other

DINOX NC TOTAL TOOLING SYSTEM

DIGITAL 3D-TASTER	308
3D-TASTER 2007	308
HDG	309
DZH	310
DZP	310
DZOP	311
DOP	311
ROT	312
TB	313
SC	313
NTSS	314
Shank spec	315
Pull stud bolt	323
INDEX	324

1:1 CHAT



DIGITAL 3D TASTER

Features

- High measurement accuracy: 0.01mm
- Display indication unit: 0.005mm
- Easy to check measured values through a highly visible display
- Omnidirectional movement and measurable stylus
- Highly waterproof and shockproof structure (IP65 class)
- Convenient and simple concentricity adjustment
- Compatible with conventional styluses
- -, + indicated according to movement direction based on zero reference
- Built-in CR2032 battery



• ● : Stock

X,Y,Z axes Driving range	Measurement unit	Display range	Zero accuracy	Zero repetitive accuracy	Shank diameter	Battery classifications	Weight(g)	Stock
-2 / to 4	0.005 (5µm)	±2	±0.01	±0.005	Ø16	CR2032	520	●

(Unit : mm)

1:1 CHAT



3D TASTER 2007

Features

- High measurement accuracy : 0.01mm
- Easy zero adjustment
- Highly waterproof and vibration-proof structure (IP67 class)
- Screw-type stylus Prevents the stylus from falling out by vibration and shock
- Simple and accurate radial run-out measurement Radial run-out measured directly from the lower part of the scanning arm.
- Radial direction and axial direction measurable with one indicator

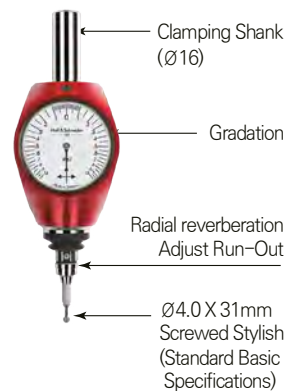
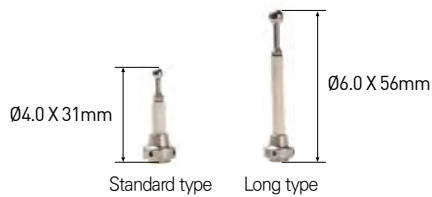

• ● : Stock

Measurement unit	Measurement precision	Shank diameter	Weight (g)	Stock
0.01	0.01	Ø16	397	●

(Unit : mm)



HDG Hydraulic expansion chuck gauge

Features

- A gauge for a hydraulic chuck that is able to determine whether the clamping force is normal or not before processing
- Able to minimize the error rate due to lowered clamping force of the hydraulic chuck
- Able to prevent defective processing caused by tool fallout

NAMING

HDG	20
Hydraulic expansion chuck gauge	Tool Dia.

How to Measure Clamping Force

How to check if the hydraulic chuck is out of order by using HDG

1. Assemble the head fitting the hydraulic chuck's internal diameter with the body
2. Insert into the hydraulic chuck and set to "0" on the dial gauge.
3. After clamping the hydraulic chuck, check if the clamping force of the hydraulic chuck is normal or not based on the movement of the dial gauge.



- ※ After observing an increased volume, always check the table and determine whether to use the hydraulic chuck or not
- ※ Not compatible with other companies' hydraulic chucks

● : Stock

- ※ The measured value is based on the DONOX hydraulic chuck, and there may be a difference in specific values of other companies' products.
- ※ If the value is measured below the inspection range, please contact the place of purchase.

Model No.	Hydraulic chuck tool dia	Usable range	Inspection range	Stock
HDG-6	Ø6	80 이상	70~80µm	●
HDG-7	Ø7	80 이상	70~80µm	
HDG-8	Ø8	80 이상	70~80µm	●
HDG-9	Ø9	120 이상	110~120µm	
HDG-10	Ø10	100 이상	90~100µm	●
HDG-12	Ø12	120 이상	110~120µm	●
HDG-14	Ø14	150 이상	140~150µm	
HDG-16	Ø16	150 이상	140~150µm	●
HDG-18	Ø18	150 이상	140~150µm	
HDG-20	Ø20	160 이상	150~160µm	●
HDG-25	Ø25	190 이상	180~190µm	
HDG-32	Ø32	160 이상	150~160µm	



Operation

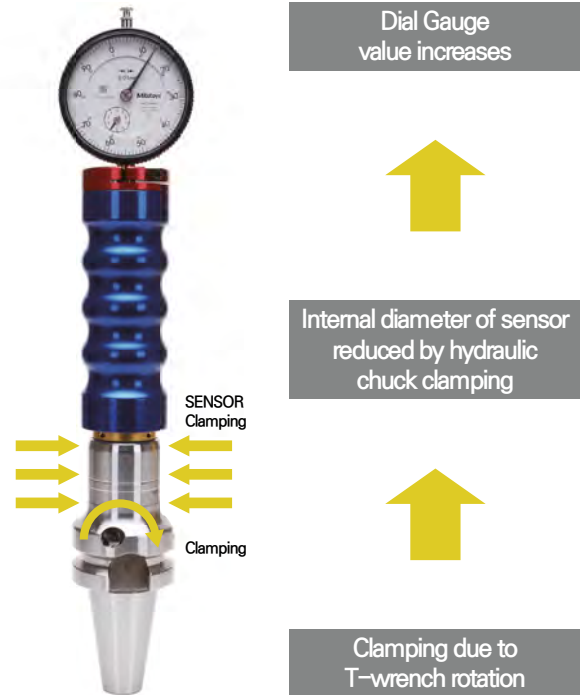

Chuck

Arbor/Modular

Boring tool

Angular head

CBN/PCD

TAUMAX

Other

1:1 CHAT



DZH Dine z axial height gauge

Features

- For setting up the tool Z axis of MCT
- Design setting height : 50.00 ± 0.005 mm
- Wide plane face, easy operation
- Relatively less spring ejection and designed to prevent the milling cutter or bite from breaking
- Using a polished parallel plate enables an easy setting.
- Good parallelization degree, quick use response to each direction, and good accuracy
- Easy adjustment of the height of the measuring stand.
- Using a hexagonal wrench enables an immediate zero (0) adjustment.
- Magnetic attachment type



- ● : Stock

Model No.	Height	G.W.Weights Kgs	LxWxH/Unit	Stock
DZH-50	50.00 ± 0.005	1.2kgs	50X63X63	●

(Unit : mm)

1:1 CHAT



DZP Dine z axial setting height gauge

Features

- For setting up the tool Z axis of MCT
- Design setting height: 100.00 ± 0.005 mm
- Wide plane face, easy operation
- Enables relatively less spring ejection; prevents the milling cutter or bite from breaking
- Using a polished parallel plate enables an easy setting.
- Good parallelization degree, quick use response to each direction, and good accuracy
- Magnetic attachment type



- ● : Stock

Model No.	Height	G.W.Weights Kgs	LxWxH/Unit	Stock
DZP-100	± 0.005	0.73kgs	100X50X50	●

(Unit : mm)



DZOP Dine z axial preset gauge

Features

- For setting up the tool Z axis of MCT
- Design height : 50.00
- Wide plane face, easy operation
- Relatively less spring ejection and designed to prevent the milling cutter or bite from breaking
- Using a polished parallel plate enables an easy setting.
- Good parallelization degree, quick use response to each direction, and good accuracy
- It emits light when touched.
- Magnetic attached type



- ● : Stock

Model No.	Height	G.W.Weights Kgs	LxWxH/Unit	Stock
DZOP-50	50	0.6kgs	50X53X53	●

(Unit : mm)



DOP Dine optical edge finder

Features

- Long-time no rust as it is waterproof treated on the whole
- Note : An optical laser type cardiopulmonary system is not suitable for rotation applications
- It sounds an alarm when touched



- ● : Stock

Model No.	G.W.Weights Kgs	Accuracy	LxWxH/Unit	Stock
DOP-20B	0.3kgs	±0.005	158X20X10	●

(Unit : mm)

Chuck

Arbor/Modular

Boring tool

Angular head

CBN/PCD

TAUMAX

Other



ROT

Run out tester

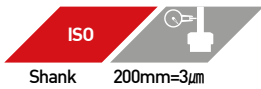

Features

- Compatible with various shanks; provides diverse lineups
 - Compliant with ISO30~ISO50 (ISO: BT,SK, NT,CAT) affordable general type and multi-type that can measure the cutting edge height and outer diameter simultaneously



Model No. / Description

Model No.		Main component				Accessories	
ROTS	ROTM	Shank	Body	Housing	Retainer	ARM	Indicator
ROTS-ISO15	ROTM-ISO15	ISO15	ROTM-BD (Multi-type) ROTS-BD (General type)	ROT-HS-ISO15	ROT-RTB-ISO15	MB -1030-2	DIAL GAUGE (0.002mm)
ROTS-ISO20	ROTM-ISO20	ISO20		ROT-HS-ISO20	ROT-RTB-ISO20		
ROTS-ISO25	ROTM-ISO25	ISO25		ROT-HS-ISO25	ROT-RTB-ISO25		
ROTS-ISO30	ROTM-ISO30	ISO30		ROT-HS-ISO30	ROT-RTB-ISO30		
ROTS-ISO40	ROTM-ISO40	ISO40		ROT-HS-ISO40	ROT-RTB-ISO40		
ROTS-ISO50	ROTM-ISO50	ISO50		ROT-HS-ISO50	ROT-RTB-ISO50		

Simple measurements

Measure run-out easily by inserting and turn the tool



① After inserting the tool

② Check R/O by turning the tool

Convenient horizontal adjustability

Can check horizontality by the level installed.



ROTS-General type (~Ø150)

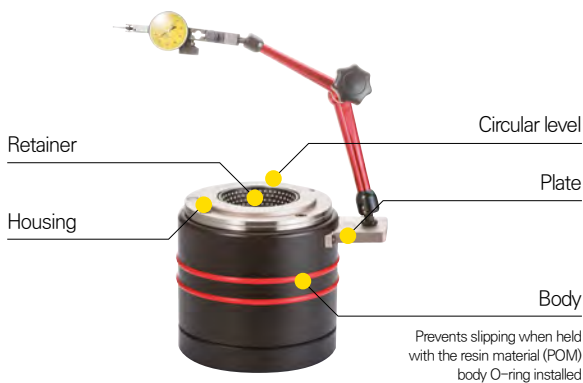

ROTM-Multi type (~Ø400)



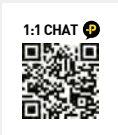

TB

Test bar

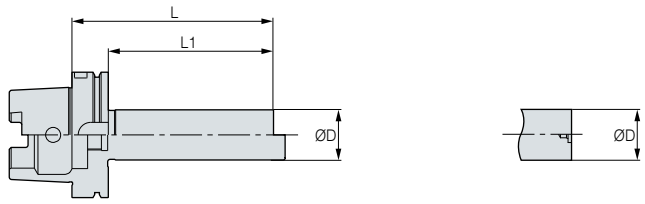

● : Stock

Shank	Model No.	ØD	L	Stock
BT Shank	BTN30-TB30-200	30	200	●
BT Shank	BTN40-TB50-300	50	300	●
BT Shank	BTN50-TB50-300	50	300	●
HSK Shank	HSK40A-TB25-200	25	200	
HSK Shank	HSK50A-TB32-250	32	250	
HSK Shank	HSK63A-TB40-300	40	300	●
HSK Shank	HSK100A-TB40-350	40	350	●

(Unit : mm)



SC

Spindle cleaner

Features

Made from sheepskin.
By cleaning the inside of the spindle, it prevents spindle damage and static electricity, extending the life of the spindle.



● : To be discontinued
● : Stock

Model No.	Taper	N.W	G.W	Stock
SC-BT30	BT30	0.06kg	0.08kg	●
SC-BT40	BT40	0.07kg	0.1kg	●
SC-BT50	BT50	0.16kg	0.2kg	●
SC-HSK50	HSK50	0.08kg	0.12kg	●
SC-HSK63	HSK63	0.1kg	0.13kg	●
SC-HSK100	HSK100	0.5kg	0.7kg	●

(Unit : mm)

Chuck

Arbor/Modular

Boring tool

Angular head

CBN/PCD

TAUMAX

Other



NTSS New tool setting stand

Features

- Made of aluminium alloy
- Two types Vertical or Horizontal available All of BT, CAT, SK available

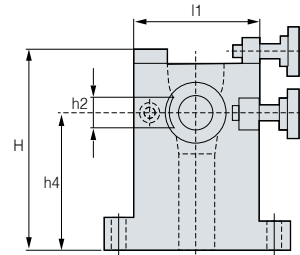
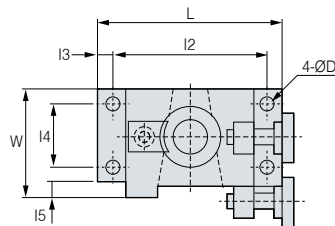

- ● : Stock

Model No.	Type	L	I1	I2	I3	I4	H	W	G.W	Stock
NTSS-30	BT30	95	65	80	7.5	33	100	58	1kg	●
NTSS-40	BT40	118	77	99	9.2	44	130	75	1.7kg	●

(Unit : mm)

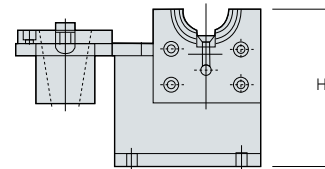
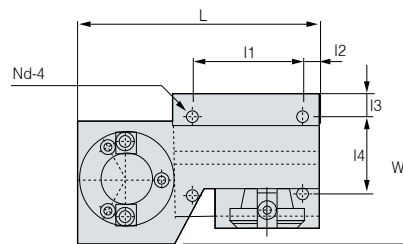

- ● : Stock

Model No.	Type	L	I1	I2	I3	I4	H	W	G.W	Stock
NTSS-50	BT50	275	113	20	24	105	200	150	11.4kg	●

(Unit : mm)

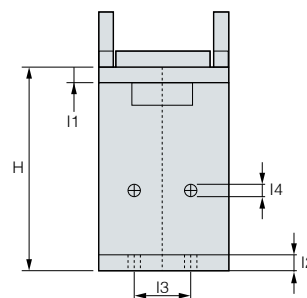
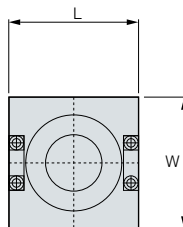

- ● : Stock

Model No.	Type	L	I1	I2	I3	I4	H	W	G.W	Stock
NTSS-HSK63A	HSK63A	106	11	11	50	9	160	106	4.1kg	●

(Unit : mm)



BOTTLE GRIP TAPER MAS403-BT

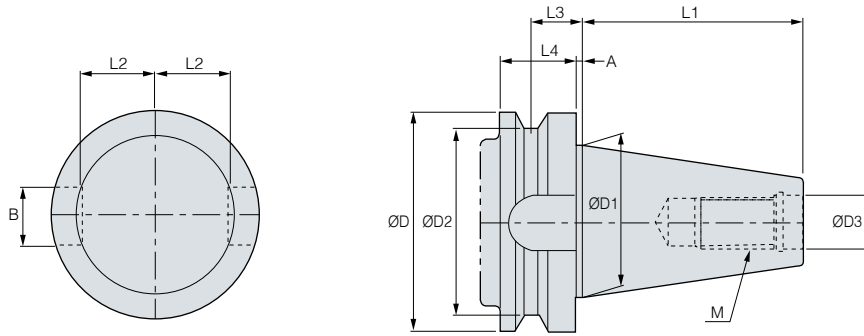

TAPER	ØD	ØD1	ØD2	ØD3	L1	L2	L3	L4	A	B	M
BT30	46	31.75	38	12.5	48.4	16.3	13.6	20	2	16.1	M12 x 1.75
BT40	63	44.45	53	17	65.4	22.6	16.6	25	2	16.1	M16 x 2
BT50	100	69.85	85	25	101.8	35.4	23.2	35	3	25.7	M24 x 3
BT60	155	107.95	135	31	161.8	60.1	28.2	45	3	25.7	M30 x 3.5

(Unit : mm)



CAT SHANK (ANSI/ASME B5.50-1985)

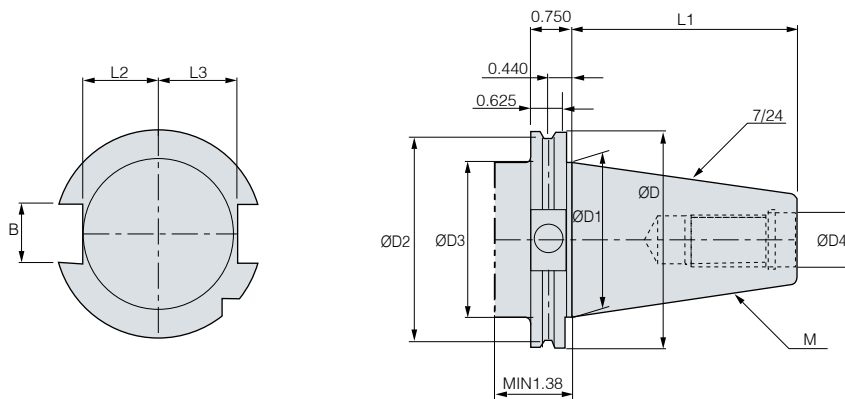

TAPER	ØD	ØD1	ØD2	ØD3	ØD4	L1	L2	L3	B	M
CAT30	1.812	1.25	1.531	1.25	0.516	1.875	0.64	0.735	0.645	UNC 0.500-13
CAT40	2.500	1.75	2.219	1.75	0.641	2.687	0.89	0.985	0.645	UNC 0.625-11
CAT50	3.875	2.75	3.594	2.75	1.031	4.0	1.39	1.485	1.02	UNC 1.000-8
CAT60	5.500	4.25	5.219	4.25	1.281	6.375	2.14	2.235	1.02	UNC 1.250-7

(Unit : mm)

Chuck

Arbor/Modular

Boring tool

Angular head

CBN/PCD

TAUMAX

Other



DIN 69871-1 A/B, ISO 7388/1:1983(E)

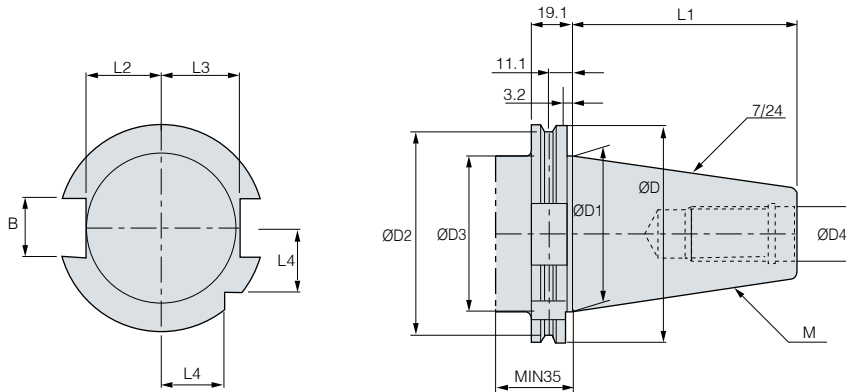

TAPER	ØD	ØD1	ØD2	ØD3	ØD4	L1	L2	L3	L4	B	M
SK30	50	31.75	44.3	45	13	47.8	16.4	19	15	16.1	M12 x 1.75
SK40	63.55	44.45	56.25	50	17	68.4	22.8	25	18.5	16.1	M16 x 2.0
SK50	97.5	69.85	91.25	80	25	101.75	35.5	37.7	30	25.7	M24 x 3.0

(Unit : mm)



DIN 2080, JIS B 6101, ISO 297:1988(E)

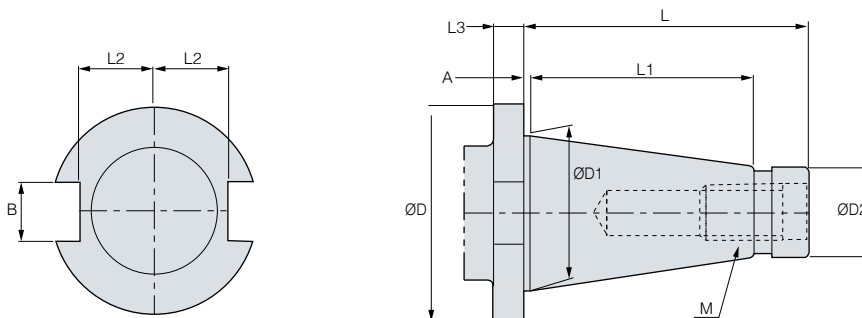

TAPER	ØD	ØD1	ØD2	L	L1	L2	L3	A	B	M
NT30	46	31.75	17.4	68.4	48.4	16.2	10	1.6	16.1	UNC 1/2-13
NT40	63	44.45	25.3	93.4	65.4	22.5	10	1.6	16.1	UNC 5/8 - 11
NT50	100	69.85	39.6	126.8	101.8	35.3	14	3.2	25.7	UNC 1 - 8
NT60	155	107.95	60.2	206.8	161.8	60	15	3.2	25.7	UNC 1,1/4 - 7

(Unit : mm)



MORSE TAPER (Tang type)

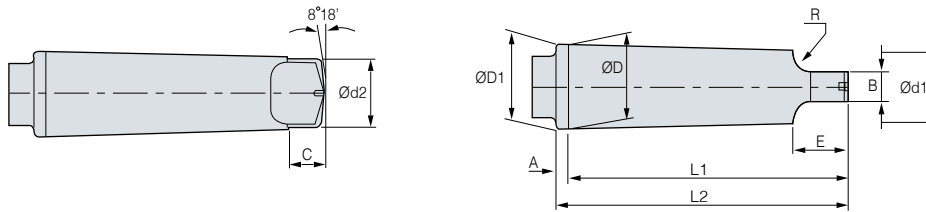

TAPER	Taper	Taper Angle(α)	$\varnothing D$	A	$\varnothing D1$	$\varnothing d1$	L1	L2	$\varnothing d2$	B	C	E	R	r
MT0	1/19.212	1°29'27"	9.045	3	9.201	6.104	56.5	59.5	6	3.9	6.5	10.5	4	1
MT1	1/20.047	1°25'43"	12.065	3.5	12.24	8.972	62	65.5	8.7	5.2	8.5	13.5	5	1.2
MT2	1/20.020	1°25'50"	17.78	5	18.03	14.034	75	80	13.5	6.3	10	16	6	1.6
MT3	1/19.922	1°26'16"	23.825	5	24.076	19.107	94	99	18.5	7.9	13	20	7	2
MT4	1/19.254	1°29'15"	31.267	6.5	31.605	25.164	117.5	124	24.5	11.9	16	24	8	2.5
MT5	1/19.002	1°30'26"	44.399	6.5	44.741	36.531	149.5	156	35.7	15.9	19	29	10	3
MT6	1/19.180	1°29'36"	63.348	8	63.765	52.399	210	218	51	19	27	40	13	4
MT7	1/19.231	1°29'22"	83.058	10	83.578	68.186	286	296	66.8	28.6	35	54	19	5

(Unit : mm)



MORSE TAPER (Screw type)

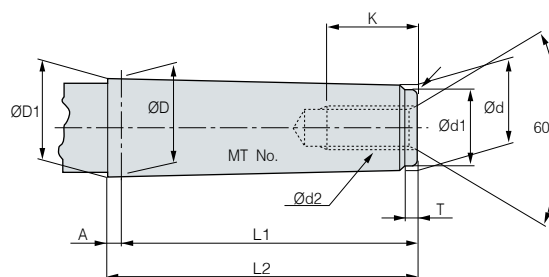

TAPER	Taper	Taper Angle(α)	$\varnothing D$	A	$\varnothing D1$	d	L1	L2	$\varnothing d1$	d2	K	T	R
MT0	1/19.212	1°29'27"	9.045	3	9.201	6.442	50	53	6.4	-	-	4	0.2
MT1	1/20.047	1°25'43"	12.065	3.5	12.230	9.396	53.5	57	9.4	M6	16	5	0.2
MT2	1/20.020	1°25'50"	17.780	5	18.030	14.583	64	69	14.6	M10	24	5	0.2
MT3	1/19.922	1°26'16"	23.825	5	24.076	19.759	81	86	19.8	M12	28	7	0.6
MT4	1/19.254	1°29'15"	31.267	6.5	31.605	25.943	102.5	109	25.9	M16	32	9	1
MT5	1/19.002	1°30'26"	44.399	6.5	44.741	37.584	129.5	136	37.6	M20	40	9	2.5
MT6	1/19.180	1°29'36"	63.348	8	63.765	53.859	182	190	53.9	M24	50	12	4
MT7	1/19.231	1°29'22"	83.058	10	83.578	70.058	250	260	70	M33	80	18.5	5

(Unit : mm)



SPARE PARTS

CLAMP BOLT (FMA, FMC, TBC, FBC, DBC)

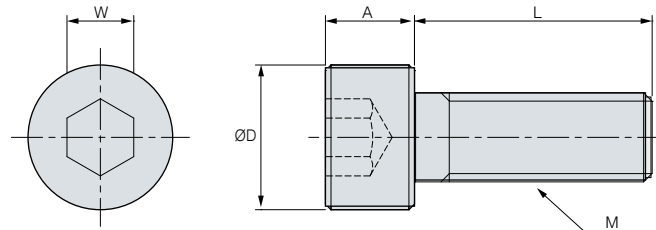

Model No.	M	A	L	ØD	W
BX0310	M3x0.5	3	10	5.5	2.5
BX0412	M4x0.7	4	12	7	3
BX0416	M4x0.7	4	16	7	3
BX0515	M5x0.8	5	15	8.5	4
BX0516	M5x0.8	5	16	8.5	4
BX0616	M6x1.0	6	16	10	5
BX0620	M6x1.0	6	20	10	5
BX0625	M6x1.0	6	25	10	5
BX0630	M6x1.0	6	30	10	5
BX0820	M8x1.25	8	20	13	6
BX0825	M8x1.25	8	25	13	6
BX0830	M8x1.25	8	30	13	6
BX1020	M10x1.5	8	20	16	8
BX1030	M10x1.5	8	30	16	8
BX1035	M10x1.5	8	35	16	8
BX1230	M12x1.75	12	30	18	10
BX1235	M12x1.75	12	35	18	10
BX1640	M16x2.0	16	40	24	14
BX1645	M16x2.0	16	45	24	14

(Unit : mm)

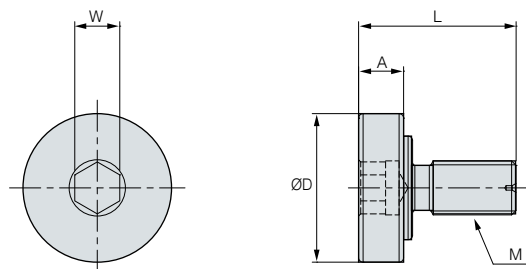

Model No.	M	A	L	ØD	W
MBA-M8	M8x1.25	7	26	20	6
MBA-M10	M10x1.5	9	32	28	8
MBA-M12	M12x1.75	10	35	33	10
MBA-M16	M16x2.0	10	50	40	14
MBA-M20	M20x2.5	14	54	50	17
MBA-M24	M24x3.0	14	62	65	19

(Unit : mm)



SPARE PARTS

TAPER SCREW (SLA, FF, MD, EXT, RDC)

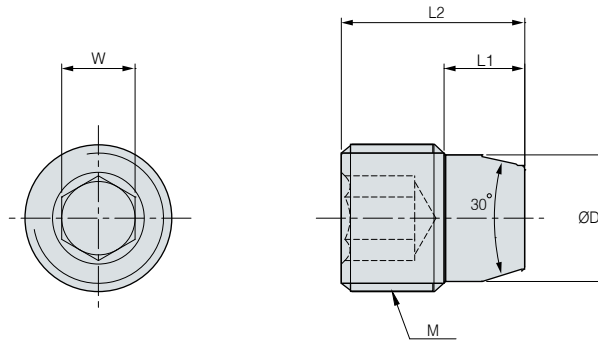

Model No.	M	L1	L2	ØD	W
BTT0506F	M5x0.5	2.8	5.5	4.1	2.5
BTT0608F	M6x0.75	3.8	8	4.9	3
BTT0810F	M8x0.75	4.8	10	6.9	4
BTT1013F	M10x1.0	5.75	13	8.5	5
BTT1215F	M12x1.0	6.8	16	10.5	6
BTT1620F	M16x1.5	8.8	20	13.8	8
BTT1626F	M16x1.5	10.75	26	13.8	8
BTT1631F	M16x1.5	10.75	31	13.8	8

(Unit : mm)

SET SCREW (TBC/FBC)

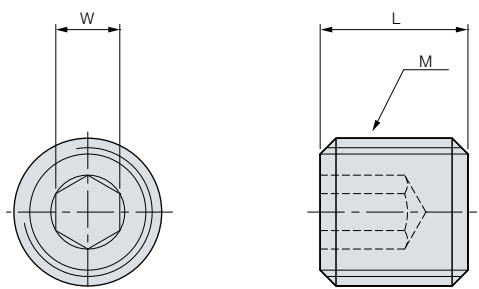

Model No.	M	L1	W
BT0645	M6x1.0	45	3
BT0660	M6x1.0	60	3

(Unit : mm)

Chuck

Arbor/Modular

Boring tool

Angular head

CBN/PCD

TAUMAX

Other



SPARE PARTS

CLAMP BOLT (FBB BITE)

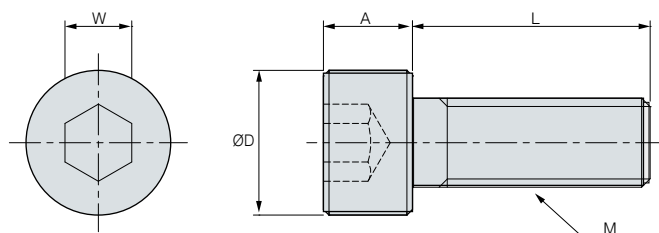

Model No.	M	A	L	ØD	W
BXC0304	M3x0.5	2	5	5.5	2
BXC0405	M4x0.7	2.8	6	7	2.5
BXC0506	M5x0.8	3.5	6	8.5	3
BXC0610	M6x1.0	4	10	10	4
BXC0810	M8x1.25	5	10	13	5

(Unit : mm)

INSERT SCREW

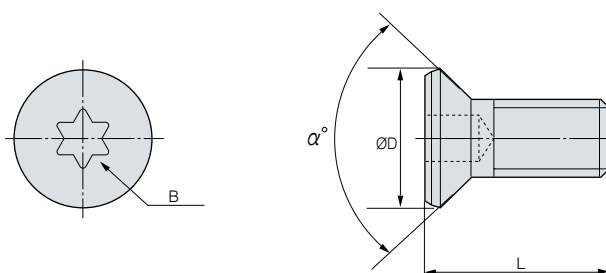

Model No.	M	L	ØD	B	α°	(N·m)
BFTX0203A	2×0.4	3	2.7	T6	90	0.5
BFTX0204A	2×0.4	4.3	2.7	T6	90	0.5
BFTX0307A	3×0.5	6.8	4.3	T10	90	2.0
BFTX0410A	4×0.7	10.3	5.6	T15	90	3.4
BFTX02506N	2.5×0.45	5.5	3.45	T8	60	1.5

(Unit : mm)



INDEX

ABC Index

NUMBER

□NU-CNGA□□□□□□	cBN/PCD	cBN Series	250
□NU-DNGA□□□□□□	cBN/PCD	cBN Series	250
□NU-VNGA□□□□□□	cBN/PCD	cBN Series	251
2NU-CCGW□□□□□□	cBN/PCD	cBN Series	251
2NU-DCGW□□□□□□	cBN/PCD	cBN Series	251
2NU-VBGW□□□□□□	cBN/PCD	cBN Series	252
2NU-VCGW□□□□□□	cBN/PCD	cBN Series	252
3D-TASTER 2007	Other	3D Taster	308
3NU-TCGW□□□□□□	cBN/PCD	cBN Series	251
3NU-TNGA□□□□□□	cBN/PCD	cBN Series	250
3NU-TPGB□□□□□□	cBN/PCD	cBN Series	252
3NU-TPGN□□□□□□	cBN/PCD	cBN Series	251
3NU-TPGW□□□□□□	cBN/PCD	cBN Series	251
4NS-CNGA□□□□□□	cBN/PCD	cBN Series	253
4NS-DNGA□□□□□□	cBN/PCD	cBN Series	253
4NU-SNGA□□□□□□	cBN/PCD	cBN Series	250
5-AXIS CENTERING VISE-FVT	TAUMAX	5축 센터링 바이스	298

A

ANGULAR HEAD	Angular head	Angular head	224
Air Turbine Spindle(ATM)	Angular head	Air spindle	242

B

BB BITE	Boring tool	BB Bite (For SMB, SMH, KMB)	210
BCF	Boring tool	Micro boring bar	218
BH	Boring tool	Boring bite	210
BKA	Boring tool	FZ micro boring bar	214
BORING INSERT	Boring tool	Boring insert	221
BSA	Boring tool	Boring bar	212
BSA SPARE PART	Boring tool	Boring bar related parts	213

C

CAT SHANK	Other	CAT shank specifications	315
cBN 알뜰표	cBN/PCD	cBN Series	250
cBN SERIES(Fiture)	cBN/PCD	cBN Series Features	256
cBN TECHNICAL DATA	cBN/PCD	cBN Technical data	279
cBN(For Cast iron)	cBN/PCD	For cBN cast iron	266
cBN(For Heat treatment steel)	cBN/PCD	For cBN heat-treated steel	260
cBN(For Sintered metal)	cBN/PCD	For cBN sintered parts	268
CCMT□□□□□□	cBN/PCD	PCD Series	254
CCMW□□□□□□	cBN/PCD	cBN Series	252
CLEAN-TEC FAN	TAUMAX	Clean-Tec Fan	302
CLEAN-TEC FAN SPARE PART	TAUMAX	Clean-Tec Fan related parts	302
CNMA□□□□□□	cBN/PCD	cBN Series	252
CNMM□□□□□□	cBN/PCD	PCD Series	254
CNMW□□□□□□	cBN/PCD	PCD Series	254
CS/CM(2pieces type)	Chuck	Shrinking chuck 2Piece type	63

D

DB1000	cBN/PCD	Uncoated cBN	274
DB2000	cBN/PCD	Uncoated cBN	275
DB7000	cBN/PCD	Uncoated cBN	276
DB7500	cBN/PCD	Uncoated cBN	277
DBC	Boring tool	Boring tool (rough-boring)	180
DBC SPARE PART	Boring tool	Balance cut tool related parts	184
DBC(Modular type)	Boring tool	Boring tool (modular type)	182
DBCA	Boring tool	Two-way controllable DBCA	170
DBCA SPARE PART	Boring tool	Two-way controllable DBCA related parts	184
DBCA(Helical type)	Boring tool	Two-way controllable DBCA (spiral shape)	172
DBCA(Straight type)	Boring tool	Two-way controllable DBCA (straight-line shape)	176
DC	Chuck	Straight collet	77
DCGT□□□□□□	cBN/PCD	PCD Series	254
DCGW□□□□□□	cBN/PCD	cBN Series	251
DCJ	Chuck	Jetcoolant collet for milling chuck	67
DCL	Chuck	Non-slip milling chuck collet	79
DCL SPARE PART	Chuck	Non-slip milling chuck collet related parts	80
DCMT□□□□□□	cBN/PCD	PCD Series	254



INDEX

ABC Index

DCS	Chuck	Straight collet	76
DHC	Chuck	Hydraulic expansion chuck collet	45
DHE	Chuck	Hydraulic expansion chuck	37
DHE SPARE PART	Chuck	Hydraulic expansion chuck related parts	46
DHE/S	Chuck	Slim hydraulic expansion chuck	34
DHE/S SPARE PART	Chuck	Slim hydraulic expansion chuck related parts	36
DHJ	Chuck	Hydraulic expansion chuck jetcoolant collet	46
DIGITAL 3D-TASTER	Other	Digital 3D taster	308
DIN 2080, JIS B 6101, ISO 297 : 1988[E]	Other	NT shank specifications	316
DIN 69871-1 A/B, ISO 7388/1 : 1983[E]	Other	SK shank specifications	316
DIN 69893-1, ISO 12164-1 : 2001	Other	HSK shank specifications	317
DJT	Chuck	Drill chuck arbor	81
DNC100	cBN/PCD	Coated cBN	270
DNC250	cBN/PCD	Coated cBN	271
DNC300	cBN/PCD	Coated cBN	272
DNC350	cBN/PCD	Coated cBN	273
DNMA□□□□□□	cBN/PCD	cBN Series	252
DNMM□□□□□□	cBN/PCD	PCD Series	254
DOP	Other	Optical edge finder	311
DSC	Chuck	Shrinking chuck	49
DSC SPARE PART	Chuck	Shrinking chuck related parts	64
DSC/M(Mono curve type)	Chuck	Shrinking chuck mono curve type	56
DSC/M(Mono slim type)	Chuck	Shrinking chuck mono slim type	57
DSC/M(Mono type)	Chuck	Shrinking chuck mono type	58
DSC/M(Straight type)	Chuck	Shrinking chuck straight type	60
DSK	Chuck	Slim collet chuck	108
DSK SPARE PART	Chuck	Slim collet chuck related parts	111
DST(PAT.)	Chuck	High-speed tapping chuck	126
DTN	Chuck	Tapping chuck	122
DVT	TAUMAX	Double vise	297
DZC	Chuck	Zero fit collet	48
DZH	Other	Z axial height gauge	310
DZOP	Other	Z axial P reset gauge	311
DZP	Other	Z axial setting height gauge	310

E

ER COLLET	Chuck	ER collet	100
ER COLLET SET	Chuck	ER collet set	103
ER/L	Chuck	Non-slip collet chuck collet	104
EXT	Arbor/Modular	Extension bar	156

F

FBB BITE	Boring tool	Boring bite	169
FBC	Boring tool	Wide diameter boring for fine boring	197
FBC BITE	Boring tool	Wide diameter boring bite	200
FBC SPARE PART	Boring tool	Wide diameter boring for fine boring related parts	200
FBH/B	Boring tool	Back boring balanced type	160
FBH/B SPARE PART	Boring tool	Back boring balanced type related parts	168
FF	Boring tool	Micro boring unit	220
FF UNIT SPARE PART	Boring tool	FF unit related part	220
FMA	Arbor/Modular	Face mill arbor	143
FMA SPARE PART	Arbor/Modular	Face mill arbor related parts	145
FMC	Arbor/Modular	Face mill arbor	146
FMC SPARE PART	Arbor/Modular	Face mill arbor related parts	149
FMD	Arbor/Modular	Basic holder	201
FZ UNIT	Boring tool	FZ Micro boring unit	216
FZ UNIT SPARE PART	Boring tool	FZ unit related parts	217

Chuck

Arbor/Modular

Boring tool

Angular head

cBN/PCD

TAUMAX

Other



G	GERC	Chuck	GERC coating collet	95
	GERC COLLET SET	Chuck	GERC collet set	99
	GSK	Chuck	High-speed slim collet chuck	112
	GSK SPARE PART	Chuck	High-speed slim collet chuck related parts	117
	HC COLLET	Chuck	HC slim collet	118
	HDG	Other	Hydraulic expansion chuck gauge	309
	HRAG	Angular head	Rigidity-reinforced angular head (90 ° fixed type)	234
I	INSERT	Boring tool	FZ, FF unit insert	217
	INSERT CODE SYSTEM(ISO)	cBN/PCD	How to indicate the model no. of insert	248
K	KAC	Angular head	Fixed angle-type angular head (45 °)	238
	KAG	Angular head	Attachment-type angular head (90 °)	232
	KAH	Angular head	Collet-type angular head (90 °)	236
	KHU	Angular head	Collet-type angular head (0 ° ~ 90 °)	228
	KMB	Boring tool	Micro boring	204
	KMB SPARE PART	Boring tool	Micro boring related parts	209
M	MAGNETIC BASE	TAUMAX	Magnetic base	305
	MAH	Angular head	Rigidity-reinforced angular head	230
	MAS403-BT	Other	BT shank specifications	315
	MC MACHINE VISE-MVT-154	TAUMAX	Machine vise (standard type)	297
	MC POWER VISE-PVT	TAUMAX	Power vise (standard type)	294
	MC POWER VISE-PVTM	TAUMAX	Power vise (entry type)	295
	MD	Arbor/ Modular	Modular arbor	150
	MD SPARE PART	Arbor/ Modular	Modular arbor related parts	157
	MH-200	TAUMAX	Shrink fit device	301
	MH-200 SPARE PART	TAUMAX	Shrink fit device related parts	301
	MORSE TAPER(SCREW TYPE)	Other	Morse taper (screw type)	318
	MORSE TAPER(TANG TYPE)	Other	Morse taper (tang type)	318
	MTA	Arbor/ Modular	Morse taper arbor	142
	N	NOTCHED ENDMILL	Chuck	Notched end mill
NPM		Chuck	New power milling chuck	65
NPM SET		Chuck	New power milling chuck set	73
NPM SPARE PART		Chuck	New power milling chuck related parts	75
NPU		Chuck	Drill chuck	120
NPU SPARE PART		Chuck	Drill chuck related parts	121
NTSS		Other	Tool setting stand	314
O		OFH	Chuck	Floating holder
P	PCD SERIES	cBN/PCD	PCD Series	254
	PCD TECHNICAL DATA	cBN/PCD	PCD technical data	289
	POSITIONING BLOCK	Angular head	Positioning block	240
	PRECISION MICRO ADJUSTING CARTRIDGE	TAUMAX	Precision boring adjusting cartridge	303
	PULLSTUD BOLT WRENCH	TAUMAX	Pullstud bolt wrench	303
	PULLSTUD BOLT	Other	Pullstud bolt	323
R	RA, GA CHIPBREAKER	cBN/PCD	RA, GA chip breaker	278
	RDC	Arbor/ Modular	Reducer bar	156
	ROT	Other	Run-out tester	312
	RTJW	Chuck	Jet coolant disk	106



INDEX

ABC Index

S

SAH	Angular head	Slim angular head	227
SC	Other	Spindle cleaner	313
SDC/PL	Chuck	ER collet chuck	82
SDC/PL SPARE PART	Chuck	ER collet chuck related parts	85
SDC/P	Chuck	ER collet chuck	86
SDC/P SPARE PART	Chuck	ER collet chuck related parts	92
S-FBH/B	Boring tool	Micro boring balanced type	166
SLA	Arbor/Modular	Side lock arbor	138
SLA SPARE PART	Arbor/Modular	Side lock arbor related parts	141
SLK	Chuck	Shrinking chuck 2 Piece type	64
SMB	Boring tool	Small micro boring bar	202
SMB SPARE PART	Boring tool	Small micro boring bar related parts	209
SMH	Boring tool	Small micro boring bar(precision type)	206
SMH SET	Boring tool	Small micro boring set	208
SMH SPARE PART	Boring tool	Small micro boring bar(precision type) related parts	209
SPGN□□□□□□	cBN/PCD	PCD Series	255
S-SDC	Chuck	Collet chuck straight type	93
STER	Chuck	Synchro tapping ER collet	133

T

T-2NU-VBGW□□□□□□	cBN/PCD	cBN Series	252
T-□NU-VNGA□□□□□□	cBN/PCD	cBN Series	251
T-2NU-DCGW□□□□□□	cBN/PCD	cBN Series	251
T-2NU-VCGW□□□□□□	cBN/PCD	cBN Series	252
TAPER CLEANING DEVICE	TAUMAX	Taper cleaning device	300
TAPER CLEANING DEVICE SPARE PART	TAUMAX	Taper cleaning device related parts	300
TB	Other	Tester bar	313
TBC	Boring tool	Wide diameter boring for rough boring	192
TBC SPARE PART	Boring tool	Wide diameter boring for rough boring related parts	196
TBCA	Boring tool	Aluminium wide boring tool	186
TC	Chuck	Taper collet	78
TCA	Chuck	Tap adapter	125
T-CNMA□□□□□□	cBN/PCD	cBN Series	252
T-DCGW□□□□□□	cBN/PCD	cBN Series	253
TEH	Chuck	Tap extension holder	130
TER	Chuck	ER tap collet	129
TNMA□□□□□□	cBN/PCD	cBN Series	252
TOOL CLAMP	TAUMAX	Tool clamp	304
TPGB□□□□□□	cBN/PCD	cBN Series	252
TPGN□□□□□□	cBN/PCD	PCD Series	255
TPGW□□□□□□	cBN/PCD	PCD Series	255
T-VNMA□□□□□□	cBN/PCD	cBN Series	252

U

UC CHIPBREAKER	cBN/PCD	UC chip breaker	290
----------------	---------	-----------------	-----

V

VBGW□□□□□□	cBN/PCD	PCD Series	255
VBMT□□□□□□	cBN/PCD	PCD Series	255
VBMW□□□□□□	cBN/PCD	cBN Series	253
VCMT□□□□□□	cBN/PCD	PCD Series	255
VNMA□□□□□□	cBN/PCD	cBN Series	252

Chuck

Arbor/Modular

Boring tool

Angular head

cBN/PCD

TAUMAX

Other



Head Office [15118] 24, MTV , Siheung-si, Gyeonggi-do, Republic of Korea [Jeongwang-dong] | T. +82 031-488-6200

Branch Office in China T. +86-532-8588-5907 | E. dine@dinox.com.cn
4th/5th Floor, 88 Building, Beijing Capital Airport International Center, No.6th Changchengnan Road, Chengyang District, Qingdao, Shandong Province, China [post code : 266108]

Branch Office in Vietnam T. +84-24-7300-6991 | E. sales@dine.com.vn
4th Floor, Tower B, Golden Palace Building, Me Tri ward, Nam Tu Liem district, Hanoi, VN

Branch Office in Thailand T. +66-02-108-8911-3 | E. dine.thai@dine.co.kr
1/38 Bangna Thani Building 19B th Floor, Bangna-Trad 34 Alley, Bangna Tai Sub-district, Bangna District, Bangkok [10260]

Branch Office in Spain T. +34-911-09-59-35 | E. dms@dine.co.kr
Avda. de los Montes de Oca, 19, Nave 3, 28703, San Sebastian de los Reyes, Madrid

www.dine.co.kr E-mail : dine@dine.co.kr